

Export Catalogue 2024

REDI



Soil, Waste & Vent
Heating, Cooling & Water Supply
Surface & Floor Drainage
UGD & Sewage
Water Management

aliaxis



**we
make
life
flow**

Index

1.0	IN-BUILDING SOLUTIONS.....	8
	Soil & Waste Introduction	
1.1	PHONOBLACK.....	15
	Soundproof PVC-U Soil & Waste System	
1.2	PVC-U.....	31
	Soil & Waste System	
1.3	PP.....	75
	Soil & Waste System	
1.4	ACCESSORIES AND SPECIAL SOLUTIONS	97
1.5	VENTILATION.....	109
1.6	FLUXO	135
	Heating, Cooling, and Water Supply System	
2.0	SURFACE & FLOOR DRAINAGE SYSTEM.....	159
	Surface Drainage Introduction	
2.1	CATCH BASINS, COVERS AND GRILLS	171
2.2	RAINWATER GULLIES.....	185
2.3	MODULAR CHANNELS.....	191
2.4	FLOOR DRAINS.....	209
3.0	UNDERGROUND DRAINAGE AND SEWAGE SYSTEM.....	225
3.1	NON-RETURN VALVES AND FLAP	251
3.2	MECHANICAL SADDLES.....	269
4.0	ISEA	285
	Water Management Systems	
	LIST OF ARTICLES.....	293



The Aliaxis brand story

In a rapidly changing world, with a growing population and a changing climate, water is key. Being one of the most precious resources on our planet, we today must radically change the way we use water. As a global industry leader that connects people with water and energy, Aliaxis is ready to take up this challenge and help shape a better tomorrow.

As one of the world's largest advanced plastic piping manufacturers, we combine the strength of a global group with the diversity and passion of our local teams. We offer world-class water and energy solutions across continents, and it is the specific knowledge and experience of our people on the field that makes the difference for our customers. Whether it is designing the most efficient water supply systems or meeting the ever-growing demands of cities and their inhabitants, we work closely together with our customers and partners to deliver trusted performance, today and tomorrow.

Our global network of leading local brands, intimate market understanding, and proven technical expertise means we are well placed to collaborate with our customers, so they can access the industry's most advanced products and services. We are constantly challenging ourselves to think further and faster, ensuring we deliver ever smarter, innovative and sustainable solutions that benefit people all over the world and that make life flow.



alixis.com

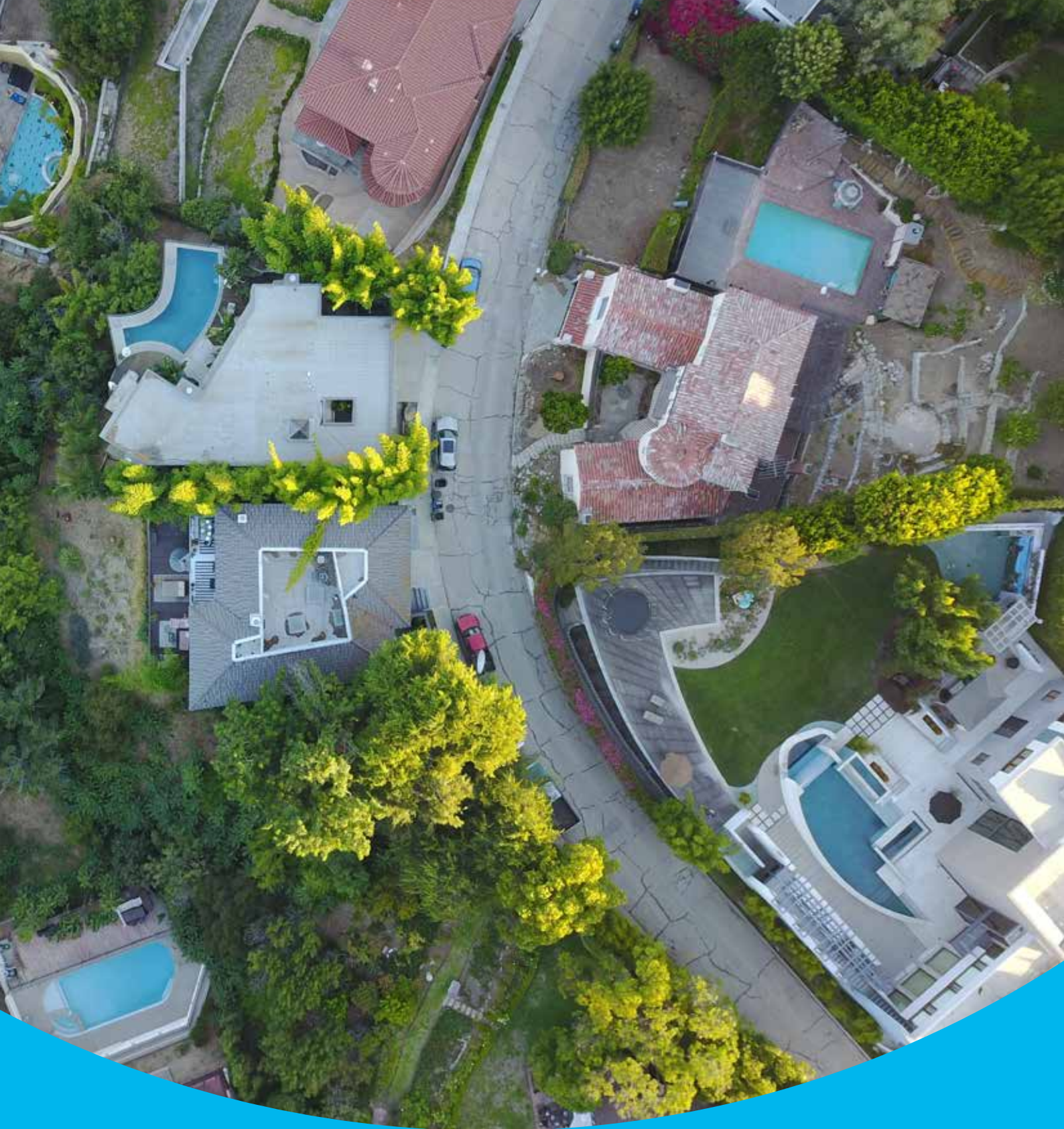

alixis

The production site in Zola Predosa, IT



Since 1960 the Redi brand is synonymous with quality sustainability and success for our customers.

The reason for this success is our constant effort in offering the most comprehensive service to our clients aiming at establishing long-lasting and profitable business relationships.

Redi is certified in accordance with quality standards UNI EN ISO 9001.

Redi brand manufactures and offers the following product ranges:

- PVC-U rubber ring-sealed fittings for underground drainage (EN 1401)
- PVC-U and pp inspection chambers (AFNOR-ANF)
- PVC-U anti-flooding valves (Ø 100 ÷ 630)
- PVC-U solvent welding fittings for above ground drainage (EN 1329 - AFNOR-ENF)
- Phonoline: soundproof piping system 12 dB (EN 14366)
- Phonoblack: soundproof piping system 13 dB (EN 14366)
- PP pipes and fittings for non-pressure above ground drainage (EN 1451)
- Ventilation systems
- ISEA, solutions for wastewater, rainwater treatment and rainwater recycle
- Surface drainage systems

Aliaxis world leader in the manufacture of building materials.

The company operates a policy of progressive improvements and reserves the right to alter the specification of any product without prior notice. Information given by way of illustrations and dimensions is intended to assist the buyer but where such information is of paramount importance it should be confirmed with the company in writing before any order is placed.

Certified in accordance with quality standards:

- UNI EN ISO 9001
- UNI EN ISO 14001
- UNI ISO 45001



Voluntary commitment to sustainable development of the European PVC industry



REDI SpA associate GBC Italy
(Green Building Council Italy)

Building Services Portfolio



3.1 NON-RETURN VALVES

3.2 MECHANICAL SADDLES

4.0 RAINWATER RECYCLE

REDI

ISEA



1.6 VENTILATION

4.0 WASTEWATER TREATMENT

1.6 HOT & COLD WATER, MULTILAYER SYSTEM

1.1 SOIL & WASTE SYSTEM

2.0 SURFACE DRAINAGE SYSTEM

Advice for drainage systems installation

Soil & Waste branches in the bathroom

The sizing of the collecting branches of all sanitary equipments is based on the fluid quantity discharged in a specific time unit. The nominal diameter of a DN branch has to be calculated by interpolation (Pict. 1) among the following variables related to any single case taken into consideration.

- Q**= flow rate expressed in liter/second
- u**= pipe usage ratio or filling factor
- J**= pipe slope expressed in %

Description of the variables:

Q: basing on the kind of user, it's possible to fix some average typical Q-rates for each sanitary equipment

Kind of Sanitary Equipment	Flow rate Q (l/sec.)	Average discharge duration (sec.)
Shower plate	0,45	13
Washbasin	0,45	13
Bidet	0,45	13
Bathtub	0,90	200
Double kitchen sink	0,90	13
Domestic washing machine	0,90	80
Dishwasher	0,90	80
Double washtub	1,50	20
Restaurant dishwasher	1,60	130
Service washing machine	1,80	140
W.C. W. & S.	2,50	10

Pict. 1

u: usage ratio calculated as $h/D = 0,5$

This filling hypothesis avoids the creation of internal counter pressures that slow the S&W down and increase its noise. In order to maintain this ratio constant, the S&W branch diameter will have to be bigger at least of a measure than the fixing point diameter.

J: by increasing the branch slope, an increase of the discharge flow speed is observed, and consequently of the S&W flow rate in the pipe itself.



By changing the slope, the same quantity of water coming out from the same equipment might be drained away by pipes of different diameters. (Pict. 2) As it is not always convenient to carry on with the dimensioning in the best conditions, through the practical experience it has been created a simplification of the dimensioning theory of the drainage networks proposed in Pict. 3.

DN	Slope J						
	Considering u=0,5 (mm)	0,5 %	1,0 %	1,5 %	2,0 %	2,5 %	3,0 %
32		0,19	0,27	0,34	0,39	0,43	0,48
40		0,30	0,43	0,54	0,61	0,67	0,74
50		0,47	0,66	0,84	0,95	1,04	1,16
63		0,54	0,76	0,95	1,08	1,19	1,32
75		0,92	1,29	1,63	1,85	2,03	2,26
80		1,21	1,70	2,14	2,43	2,67	2,96
100		1,90	2,67	3,35	3,81	4,19	4,65
110		2,47	3,46	4,04	4,59	5,44	5,60
125		2,97	4,16	5,24	5,95	6,54	7,26

Pict. 2

Sanitary Equipment kind	DN connection (mm)	DN branch (mm)
Washbasin	25/32	32/40
Bidet	25/32	32/40
Showerplate	32	40
Bathtub	32	40
Double kitchen sink	32	40
Domestic washing machine	32	40
Dishwasher	32	40
Double washtub	40	50
Restaurant dishwasher	50	63
Home washing machine	65	80
W.C. S&W	90	100

Pict. 3

Definition of the discharge flow rate of a stack

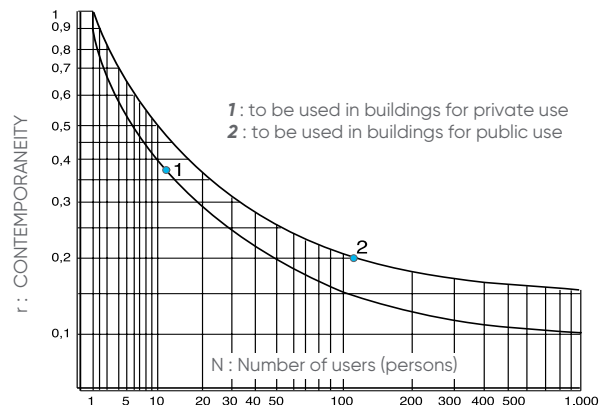

Pict. 4

The calculation of the total flow rate (Qt) of a stack or of a sewer pipe is equal to the sum of the S&W intensity of the single users, multiplied by the "r", namely usage contemporaneity ratio.

While calculating the sum of the flow rates you have to take in consideration a single sanitary equipment for each bathroom (you have to choose the equipment with the largest S&W intensity, usually the W.C.) and the other independent S&W units, i.e.: kitchen sinks, washing machines S&W, dishwasher, etc...

The variables that affect the calculation of the total Qt flow rate are connected by the following formula:

$$QT = \frac{r}{4} \times \sum Q \times \frac{N}{A} = l/sec$$

whereas:

- QT** = max discharge intensity
- Q** = discharge intensity for kind of equipment, namely one for each room (pict. 1)
- r** = contemporaneity ratio of the various bathrooms that involve the same stack (pict. 4)
- N** = number of users (persons)
- A** = number of the involved bathrooms
- ΣQ** = the sum of the discharge intensities for each floor (Q1 x n. of apartment kind 1+ Q2 x apartment kind 2 + Q3 x apartment kind 3)

Calculation example for a stack having 1 bathroom to be connected at each floor:

- QT** = ?
- Q** = considering a single sanitary equipment every bathroom, we will use for each single apartment the WC and the kitchen sink (pict. 1)
- r** = the data can be obtained by interpolation in the chart of picture 4
- N** = 20 people (4 located in each apartment)
- A** = 5 bathrooms + 5 kitchens
- ΣQ** = (Q w.c. x n. of w.c. + sink Q x n. of sinks)

$$QT = \frac{0,3}{4} \times (5 \times 2,50 + 5 \times 0,90) \times \frac{20}{10} = 2,55 l/sec$$

Dimensioning of the vertical and ventilation stacks DN1

A stack receives the discharges of various branches located on different floors: it is advisable that this stack maintain a constant section along its own length from the bottom to the roof vent cowl with a constant DN diameter. The problems related to the secondary ventilation of the stack will be discussed in the following chapter; right now we will just calculate its DN1 diameter. In order to proceed with the dimensioning it is necessary to have already defined the max flow rate (Qt).

Pict.5

QT (l/sec) Max discharge intensity	DN (mm) Ø stack	DN1 (mm) Ø secondary ventilation stack	WC Maximum installable n.	
			Total	For floor
1,74	50	40	-	-
2,03	63	50	-	-
4,51	80	63	-	-
7,24	100	80	30	6
10,57	125	80	56	8
17,25	160	100	150	16
28,26	200	110	300	38

Ventilation of the S&W systems

General remarks

The ventilation of a system is the set of pipes made up for the air passage, which is necessary for compensating the hydrostatic depressions, that originate inside gravity discharge stacks. When the water falls inside the stack (about 10 mt/sec speed) it originates an effect of compression of the below existing air, and an hydrostatic depression (vacuum) just over the referring sewage unit. The ventilation must temporarily fill in this vacuum, thus avoiding the emptying of the trap interceptors of each single connected system; it must also limit as much as possible the water fluttering inside the stack, which causes the S&W noise. The main cause that originates pressures and corresponding hydrostatic depressions has to be searched in the structure of the pipes that make up the evacuation system of the building. By following the S&W water run from the entrance into the stack until the sewage network itself we should take in consideration the variables that might occur:

Connection to the stack:

- 1) with a 87°30' Branch at constant section during the discharge there is a total closure of the pipe and a consequent pressure fall in the top stack. On the other side the air circulation inside the link pipe is good and it can be avoided the danger of the WC trap interceptor emptying.
- 2) with a Reduced 87°30' Branch during the discharge there is a partial closure of the stack with a lower pressure fall than the previous case. The air circulation inside the pipe is good by the way, and if the pipe has been measured in the appropriate way, there will be no suction phenomenon in the trap interceptors.

Pict .6

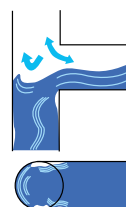

Pict .7

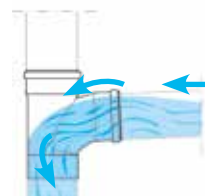
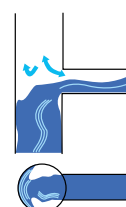

Example of installation of a Phonoline long radius branch M/F Ø110: the acoustic abatement is improved thanks to its wide radius.

3) with a 45° Branch at constant section the hydraulic closure of the stack during the discharge will be just partial. The discharge flow rate (Qt) strongly increases and the chances of emptying the trap interceptors are practically impossible.

4) with a Reduced 45° branch it will similarly happen as the previous case, a partial hydraulic closure of the stack. However, it is necessary to carefully measure the diameter of the link branch of the stack because in case of hydraulic closure there might be an emptying risk of the trap interceptors of the sanitary equipments.

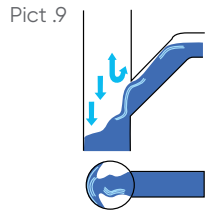
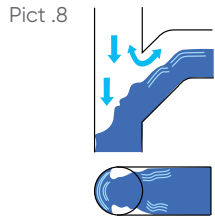
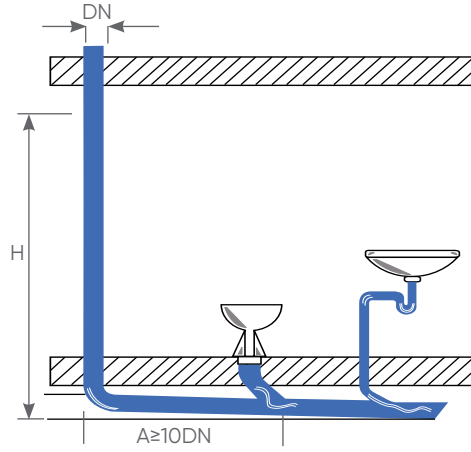

Stack bottom:

1) At the bottom of the stack where the discharge pipe gets from vertical to horizontal the water flow violently changes direction; this causes a strong increase of the internal pressure, which is proportional to the height of the stack itself. In order to weaken the impact intensity it should be advisable to get two 45° bends rather than one of 87° 30' (this general rule should be always applied when there is enough space).

2) For stacks' heights superior than 4 building storeys, the H counterpressure level caused by the stack bottom might change from 3 to 5 mt (Pict.11). It is absolutely not advisable to connect the equipments to the stack in these stretches, except for those cases in which there's a secondary ventilation (pict. 17) or a stack doubling beneath the mentioned stretch (pict. 16).

On the other hand, the link is possible along the horizontal stretch of the sewer pipe in a neutral A area, which is usually placed at a distance at least 10 times superior than the stack diameter (DN).

Stack trap interceptor

1) In order to avoid that the roof vent cowl acts like a chimney tower with the sewage system i.e. causing a drying up of the internal deposits by its constant draw, as well as the diffusion into the atmosphere of polluting substances - it is necessary to place a black waters trap interceptor (B-W) at the stack basement. For a correct positioning of the trap interceptor you must take in consideration the elevated pressure created during the discharge in the stack basement. In order to avoid the trap interceptor damaging and its bad functioning, you must keep a distance from the stack basement 10 times larger than its own diameter.

In order to get a good water flow inside the trap interceptor it is not advisable to use trap interceptors (realized by assembling bends) for the short reachable height (Hs) of water seal. REDI proposes its one piece B-W trap interceptor planned for ensuring the maximum height (Hs) equipped for the connection with the ventilation system and provided with double inspection having a diameter equal to the pipe one. REDI trap interceptor being an inspectable product must be installed inside a drain well for its periodic cleaning or for easily reaching the above placed stack in case of obstruction. In case of secondary ventilation, the basement link must be connected to the dedicated socket which is placed on the B-W trap interceptor, close to the inspection cap.

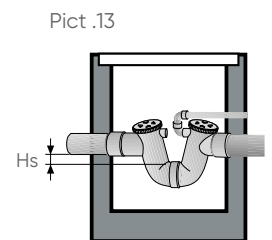
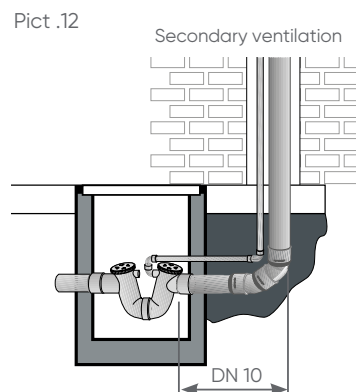
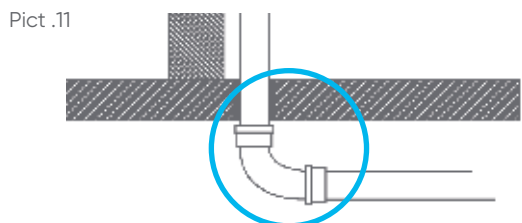

Primary ventilation

It is the easiest and most economic ventilation system. It's advisable to use it in buildings with few floors where the S&W contemporaneousness risks are limited. It is realized just with the extension of the stack getting outside, on the roof: the only important thing is to maintain the stack diameter equal until the roof-vent cowl. In case it occurs a S&W contemporaneousness in two sanitary systems placed on different floors, there might be the risk of an emptying of the intermediate-placed trap interceptors. This is due to the fact that there are no air exits that compensate the suction effect. In this case the kind of stack joint is extremely important; as a matter of fact, it must not completely obstruct the stack flow during the S&W. You can see from picture 10 that the most convenient connection may be realized with a 45° branch at constant section.

Pict.14
Primary ventilation

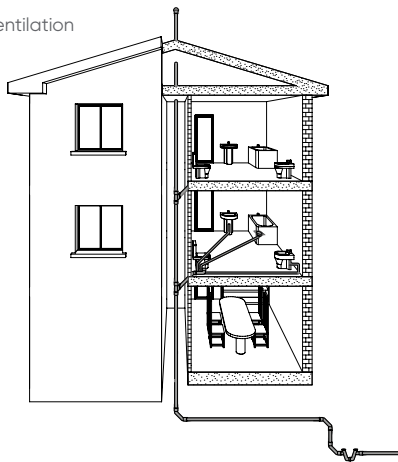

Stack secondary ventilation (roundventilation)

It consists in the stack doubling by a ventilation bypass connection located on each floor (picture 17). In this case the stack must be extended up to the roof vent cowl by always keeping its constant diameter. The joint of the secondary stack in the final section of the roof-vent cowl allows internal recycles that strongly reduce the gas flow towards the external side. This flow becomes ten times larger when a secondary stack gets outside through its own roof-vent cowl (this procedure must absolutely be avoided). In case of medium height buildings (3/4 floors) you can just connect the upper side of the ventilation stack (at least 20 cm above the 5th floor), with the connection placed above the B-W trap interceptor of the stack basis (picture 15). When the building is high (8/10 floors) the excessive stack length might create more intense suction phenomena on the lower floors; in order to avoid this problem you should connect the equipments to an independent stack (pict.16) at the level of the lower

floors. By this way you will avoid flowings, foams and noise, that occur high otherwise on the lower floors. The diameter of the secondary DN1 column must be minimum 2/3 of the diameter of the main Stack DN (pict.5); the building material is the same used for the stack: fire resistant PVC-U Me Class.

Pict.16
Secondary ventilation with max 3 floors

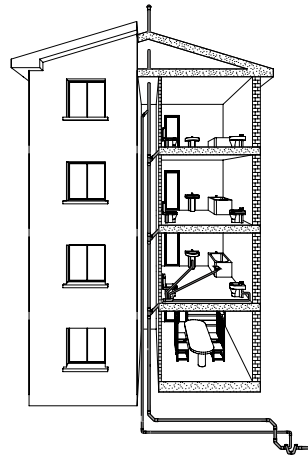

Pict.15
Secondary ventilation with auxiliary stack

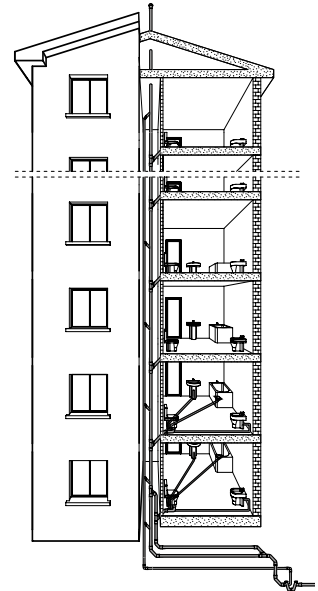
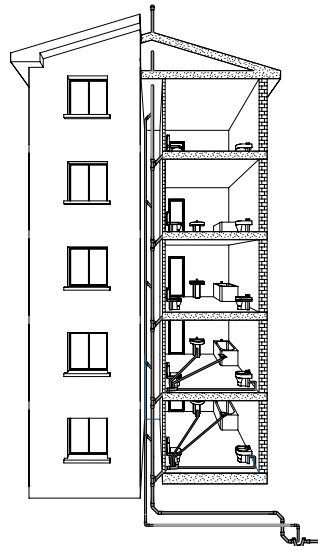

Fig.17



Pict.17
Secondary column ventilation (roundventilation)



Pict.18
Secondary ventilation

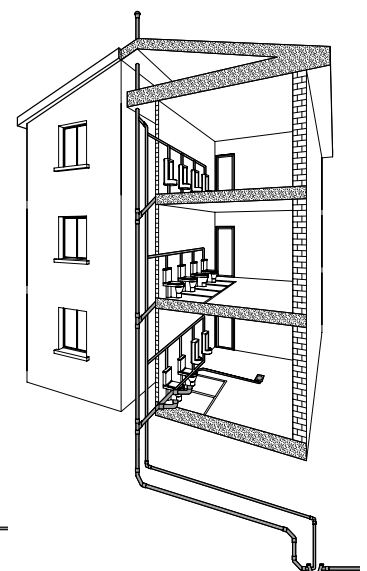

1.1

PHONOBLOCK
Soundproof PVC-U Soil & Waste System
13 dB - 2 l/s Acoustic Performance
B s1 d0 Fire Reaction Euroclass

1.6

VENTILATION
Air Admittance Valve
for primary ventilation
ARIO





1.1 **PHONOBLACK**
Soundproof PVC-U Soil & Waste System
13 dB - 2 l/s Acoustic Performance
B s1 d0 Fire Reaction Euroclass

PHONOBLOCK

Soundproof PVC-U Soil & Waste System

phono)))black

1.1 PHONOBLOCK



Push-Fit PVC-U Pipe and Fittings
13 dB - 2 l/s Acoustic Performance
B s1 d0 Fire Reaction Euroclass

alixis



The Acoustic PVC Choice

The new Phonoblock by REDI PVC mineral additives strengthened formula guarantees excellent acoustic performance. Phonoblock is designed and developed to satisfy low levels of noise emissions of waste water systems according to the different in force norm and standards.

- PVC is a sustainable and low environmental footprint material, it is lead free and completely recyclable.
- PVC allows the installation of both push-fit and solvent welded joints. It allows an excellent quick fit and give flexibility to the installers.
- PVC is suitable to be easily used to install soundproof acoustic system both for new and renovation building applications, also combined on the the already installed different type of waste water systems.
- PVC has an excellent chemical resistance to several agents like acids, alkalis, salts and organic compound solved into the water.

General characteristics of PVC

- Name: Polyvinyl Chloride
- Color: RAL 9005 - Black
- Operation Temperature Range: 70 °C is the MAX temperature of waste water in permanent conditions. For discontinuous drainage applications as common household appliances discharge, instant peak of 95 °C are allowed.



High Level System

New and innovative PVC-U compound formula with mineral additives that provide excellent performances.



Fire Reaction

Phonoblock is certified as B s1 d0 Fire Reaction Euroclass applied to plastic material made soil and waste drainage systems according to the EN 13501 standard

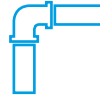

Complete Range

Pipe and Fittings available starting from Ø40 up to Ø160. Both Single and Double Socket Pipes available in 0.5, 1, 2 and 3 m length.



Exclusivity

The only one Soundproof PVC Push-Fit system also available in Ø100 on the market



Acoustic Performance

13 dB - 2 l/s acoustic performance certified by the Stuttgart Fraunhofer Physical Constructions Institute according to EN 14366 standard (P-BA 77 / 2017e).

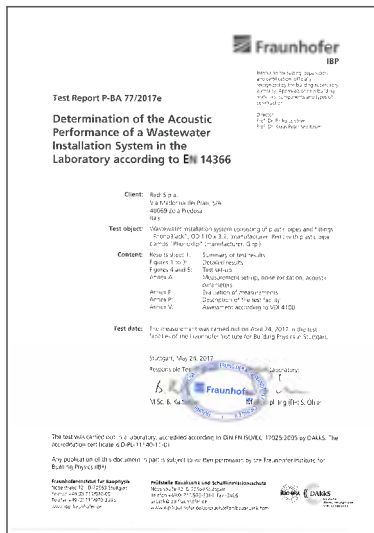

Phonoblock Euroclass certified by AFITI

Sound performance certified by Fraunhofer

The certificates shown on this catalogue may be subject to revisions. Updated certificates for each product are available on website www.aliaxis.it

Strength Points

REDI presents Phonoblack: the acoustic soil and waste system made in black PVC-U, mineral additives-strengthened, fire resistant (B s1 d0 Euroclass), available with patented and certified acoustic brackets for each diameter.

Phonoblack offers a complete range of pipes and fittings for soil and waste water applications. The innovative specific compound guarantees the soundproof performances, high chemical resistance, excellent mechanical performances even at low temperatures.



1 High quality gaskets (SBR and EPDM)

The lip seal gaskets guarantee a perfect sealing even in difficult conditions. They are slightly lubricated and temporarily removable during the installation without any issue.

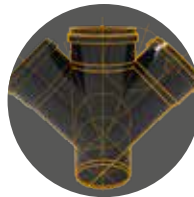

4 Soundproof geometry

The geometry of the Phonoblack fittings provide a high soundproof performance limiting the noises generated by water flow on the impact areas

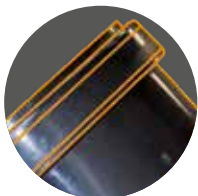

2 Total safety

Phonoblack guarantees complete sealing thanks to the square profile of the socket, even in severe working conditions (low temperatures, exposure to chemical agents)



5 Easy installation

Phonoblack is the ideal solution in renovations, allowing both the push-fit and solvent welded connections to the existing pipes.



3 High flow capacity

Thanks to the excellent smooth surface of the new PVC compound strengthened with mineral additives, Phonoblack guarantees a perfect water flow avoiding irregular outflows and clogs that cause annoying noises



6 Compact fittings

The range of Phonoblack fittings, ensures a versatile and compact system, easy to handle and ideal for specific situations where the space is limited

Phonoklip

brackets for the best performance



Essential

Brackets are essential to anchor and guide the piping network improving its performances

Patented and certified

The new Phonoklip brackets are patented and certified to reach the best acoustic performances

Totally plastic

The Phonoklip bracket, thanks to its full plastic structure, guarantees durability, flexibility and exceptional mechanical strength

Wide range

Wide range of diameters:
 Ø 50-75-90-100-110-125-160

Horizontal and vertical installation

Phonoklip brackets can be indifferently installed horizontally and vertically, both for anchoring and guiding purposes. Using Phonoklip brackets Phonoblock system reaches the highest possible performances.



For guiding purposes, keep the red spacer ring in position so that the pipe is allowed to move freely.



For anchoring purposes, remove the red spacer ring before closing the bracket

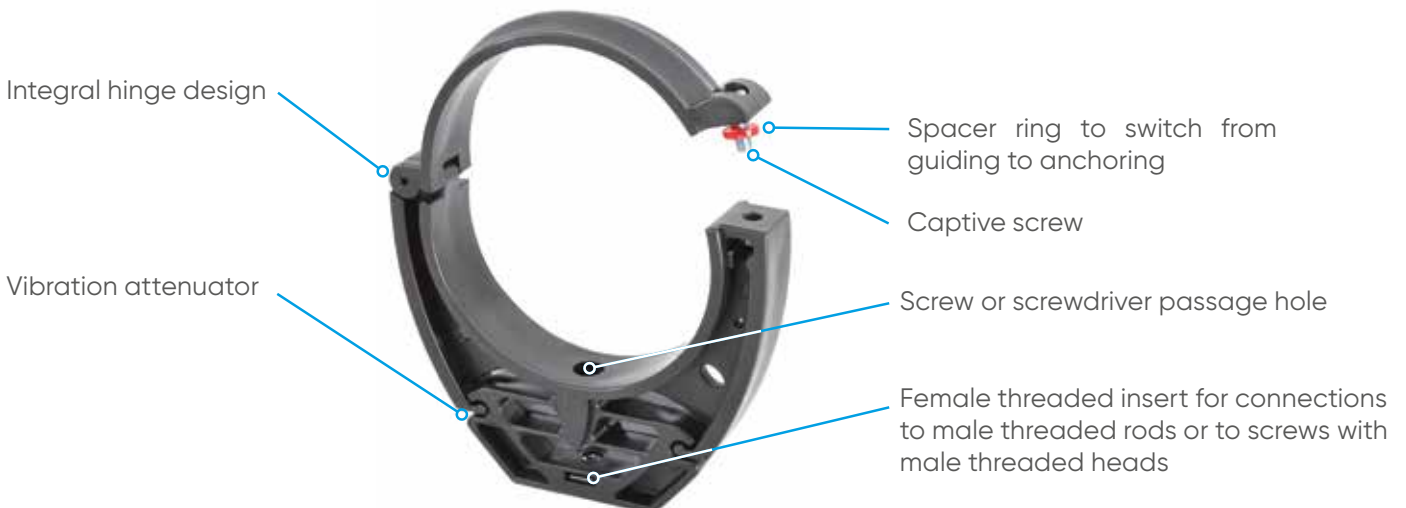

Distance between Phonoklip brackets

For vertical pipes 2 brackets must be used at each floor level:

- 1 anchor
- 1 guide

For horizontal pipes, the distance are:

- DN 50 = 0,50 m
- DN 75 - DN 125 = 0,80 m
- DN 160 = 1,00 m

Alternative configuration

for pipes drops above 10 m

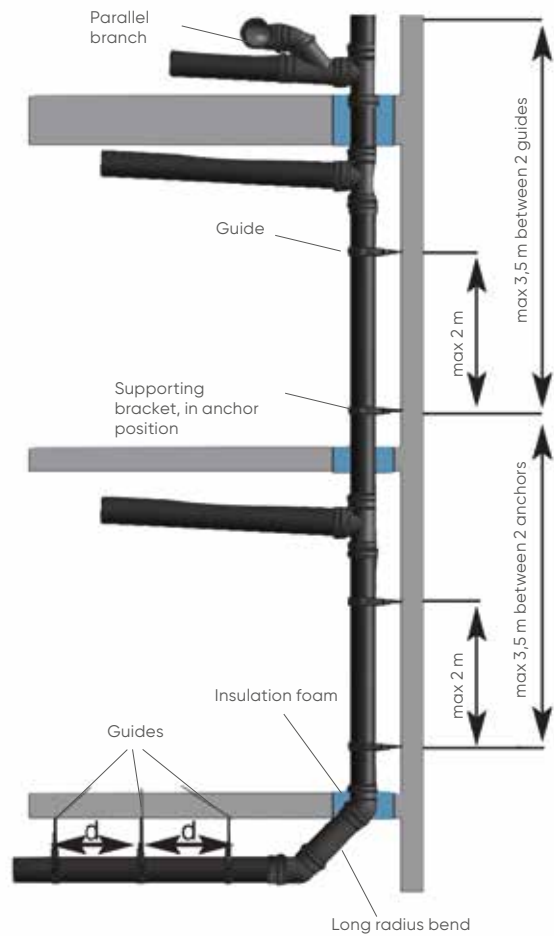
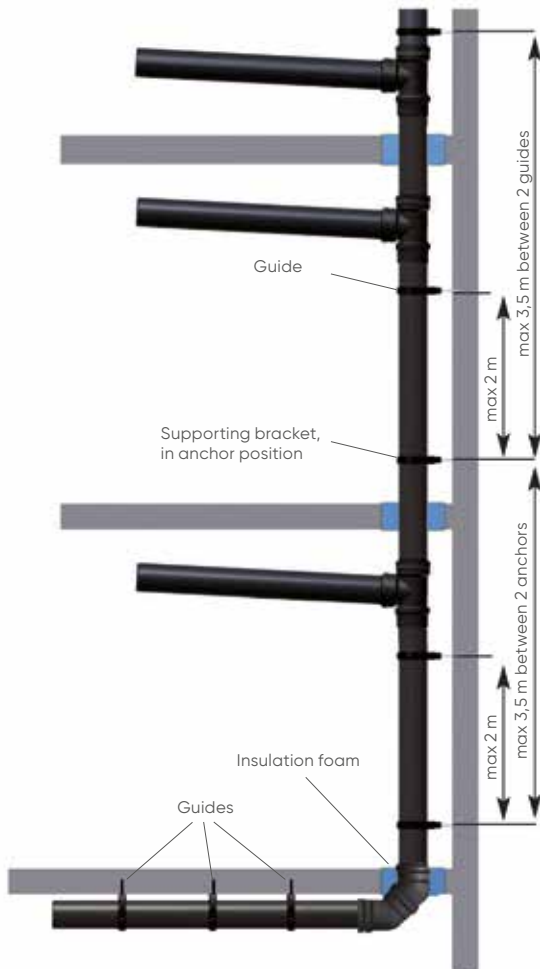

Acoustic insulation of pipes passing through floors, partitions and walls

In order to limit the transmission of structural noise, pipes must be disconnected by floors, partitions and walls each time they pass through, by use of foam or insulating material (minimum thickness 4 mm).

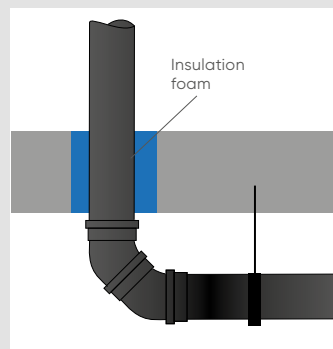

Passage through the floor.
(Up to 10 m pipe drop).

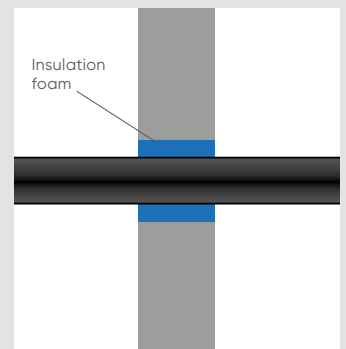

Passage through the wall or partition.

Different Situations, Unique Solution



Phonoblack can be easily connected to the existing PVC soil and waste system using a slip coupler or any other fitting by solvent welding jointing technique.



Phonoblack PVC pipe, allows the direct connection in any point along the piping stack. A new cross connection can be easily done thanks to the PVC saddle, which avoids a branch installation and let to save slab space.

Handling and storage

It is recommended to always store pipes on flat surfaces, in dry conditions and UV-protected place. Pallets must be stored at 3 m maximum height. Take care to handle pipes and fittings. Excessive scratch or impact stress on the pipe may have damage on the external surface or can affect seal properties. Take extra care to handle pipes and fittings during the winter: the low temperatures reduce the plastic material resistance to impact stress.

Tender specifications

Soundproof and fire resistant pipes and fittings system for soil and waste systems inside buildings; it can be located in a specific technical shaft, fixed with noise-insulating supports or directly embedded in the wall. Phonoblack system is made of thermoplastic mineral reinforced material.

Acoustic performance certified by German Fraunhofer Institute according to EN 14366 (13 dB at 2/ls flow rate, using Phonoklip acoustic bracket).

Push-Fit system with elastomeric lip seals certified according to the EN 681 and DIN 4060.

Pipes and fittings branded "Phonoblack by REDI".

Fire reaction B s1 d0 according to the EN 13501 standard.

PVC - Chemical resistance

Product	Conc. %	Temp. 20 °C	Temp. 60 °C	Product	Conc. %	Temp. 20 °C	Temp. 60 °C
ACETIC ACID	60	S	L	HYDROFLUORIC ACID	60	L	NS
ACETIC ACID MONOCHLORIDE	SOL.	S	L	HYDROGEN	100	S	S
ACETIC ALDEHYDE	100	NS	-	HYDROGEN DIOXIDE	30	S	S
ACETIC ANHYDRIDE	100	NS	NS	HYDROGEN SULPHIDE	100	S	S
ACETONE	100	NS	NS	IRON CHLORIDE	SOL. SAT.	S	S
ADIPIC ACID	SOL.SAT.	S	L	LACTIC ACID	10	S	L
ALLYL ALCOHOL	90	L	S	LACTIC ACID	10-90	L	NS
ALUMINUM CHLORIDE	SOL. SAT.	S	S	LEAD ACETATE	SOL. SAT.	S	S
ALUMINUM SULPHATE	SOL. SAT.	S	S	LEAD TETRAETHYL	100	S	-
AMMONIA (AQUEOUS)	100	L	NS	MAGNESIUM CHLORIDE	SOL. SAT.	S	S
AMMONIA (GAS)	100	S	S	MAGNESIUM SULPHIDE	SOL. SAT.	S	S
AMMONIA (SOLUTION)	SOL. DIL.	S	L	MALEIC ACID	SOL. SAT.	S	L
AMMONIUM CHLORIDE	SOL. SAT.	S	S	METHYL ALCOHOL	100	S	L
AMMONIUM FLUORIDE	20	S	L	METHYL METHACRYLATE	100	NS	NS
AMMONIUM NITRATE	SOL. SAT.	S	S	METHYLENE CHLORIDE	100	NS	NS
AMMONIUM SULPHATE	SOL. SAT.	S	S	MILK		S	S
AMYL ACETATE	100	NS	NS	NICKEL SULPHIDE	SOL. SAT.	S	S
AMYL ALCOHOL	100	S	L	NICOTINIC ACID	CONC.	S	S
ANILINE	100	NS	NS	NITRIC ACID	<46	S	L
ANILINE	SOL. SAT.	NS	NS	NITRIC ACID	46-98	NS	NS
ANILINE HYDROCHLORIDE	SOL. SAT.	NS	NS	OILS		S	S
ANTIMONY CHLORIDE	90	S	S	OLEIC ACID	100	S	S
ARSENIC ACID	SOL. DIL.	S	-	OLEUM	10% of SO	NS	NS
BEER		S	S	OXALIC ACID	SOL. DIL.	S	L
BENZALDEHYDE	0,1	NS	NS	OXALIC ACID	SOL. SAT.	S	S
BENZENE	100	NS	NS	OXIGEN	100	S	S
BENZOIC ACID	SOL. SAT.	L	NS	OZONE	100	NS	NS
BORAX	SOL. SAT.	S	L	PERCHLORIC ACID	10	S	L
BORIC ACID	SOL. DIL.	S	L	PERCHLORIC ACID	70	L	NS
BROMINE (LIQUID)	100	NS	NS	PETROL	80/20	NS	NS
BROMINE ACID	10	S	-	PHENOL	90	NS	NS
BUTADIENE	100	S	S	PHOSPHINE	100	S	S
BUTANE	100	S	-	PHOSPHOR TRICHLORIDE	100	NS	-
BUTYL ACETATE	100	NS	NS	PHOSPHORIC ACID	30	S	L
BUTYL PHENOL	100	NS	NS	PICRIC ACID	SOL. SAT.	S	S
BUTYLENE	100	S	L	POTASSIUM BICHROMATE	40	S	S
BUTYRIC ACID	20	S	L	POTASSIUM BROMIDE	SOL. SAT.	S	S
BUTYRIC ACID	98	NS	NS	POTASSIUM CHLORIDE	SOL. SAT.	S	S
CALCIUM CHLORIDE	SOL. SAT.	S	S	POTASSIUM CHROMATE	40	S	S
CALCIUM NITRATE	50	S	S	POTASSIUM CYANIDE	SOL.	S	S
CARBON DIOXIDE	100	S	S	POTASSIUM FERRICYANIDE	SOL. SAT.	S	S
CARBON SULPHIDE	100	NS	NS	POTASSIUM FERROCYANIDE	SOL. SAT.	S	S
CARBON TETRACHLORIDE	100	NS	NS	POTASSIUM HYDROXIDE	SOL.	S	S
CETYL ACID	100	S	S	POTASSIUM NITRATE	SOL. SAT.	S	S
CHLORINE (DRY GAS)	100	L	NS	POTASSIUM PERMANGANATE	20	S	S
CHLORINE (LIQUID)	SOL. SAT.	L	NS	POTASSIUM PERSULFATE	SOL. SAT.	S	L
CHLOROSULPHONIC ACID	100	L	NS	PROPANE (GAS LIQUID)	100	S	-
CHROMIC ACID	1-50	S	L	PYRIDINE	100	NS	-
CITRIC ACID	SOL. SAT.	S	S	SEA WATER		S	L
COPPER CHLORIDE	SOL. SAT.	S	S	SILVER NITRATE	SOL. SAT.	S	L
COPPER FLUORIDE	2	S	S	SOAP	SOL.	S	L
CREOSOL	SOL. SAT.	-	NS	SODIUM BENZOATE	35	S	L
CRESOL ACID	SOL. SAT.	NS	NS	SODIUM BISULPHITE	SOL. SAT.	S	S
CROTONIC ALDEHYDE	100	NS	NS	SODIUM CHLORATE	SOL. SAT.	S	S
CYCLOHEXANOL	100	NS	NS	SODIUM FERRICYANIDE	SOL. SAT.	S	S
CYCLOHEXANONE	100	NS	NS	SODIUM HYDROXIDE	SOL.	S	L
DEVELOPING BATH		S	S	SODIUM HYPOCHLORITE	100 (13% CL.)	S	L
DEXTRINE	SOL. SAT.	S	L	SODIUM SULPHITE	SOL. SAT.	S	L
DICHLOROETHYLENE	100	NS	NS	SUGAR	SOL. SAT.	S	S
DIGLYCOLIC ACID	18	S	L	SULPHUR ACID	SOL.	S	S
DIMETHYLAMINE	30	S	-	SULPHUR ANHYDRIDE	100 (LIQUID)	L	NS
ETHYL ACETATE	100	NS	NS	SULPHUR ANHYDRIDE	100 (DRY)	L	NS
ETHYL ACRYLATE	100	NS	NS	SULPHURIC ACID	40-90	S	L
ETHYL ALCOHOL	95	S	L	SULPHURIC ACID	96	L	NS
ETHYL ETHER	100	NS	L	TANNIC ACID	SOL.	S	S
ETHYLENE GLYCOL	CONC.	L	L	TARTARIC ACID	SOL.	S	S
FLUOSILICIC ACID	32	S	S	TIN CHLORIDE	SOL. SAT.	S	S
FORMALDEHYDE	SOL.	S	S	TOLUENE	100	NS	NS
FORMALDEHYDE	40	S	S	TRICHLOROETHYLENE	100	NS	NS
FORMIC ACID	1-50	S	L	TRIMETHYL PROPANE	<10	S	L
FURFURAL ALCOHOL	100	NS	NS	UREA	10	S	L
GLUCOSE	SOL. SAT.	S	L	URINE		S	L
GLYCERIN	100	S	S	VINAGRE		S	S
GLYCOLIC ACID	30	S	S	VINYL ACETATE	100	NS	NS
GOLDEN SYRUP	SOL.	S	L	WINE		S	S
HYDRAZINE BENZENE	100	NS	NS	XYLENE	100	NS	NS
HYDRAZINE BENZENE CLORIC	97	NS	NS	YEAST	SOL.	S	L
HYDROBROMIC ACID	50	S	L	ZINC CHLORIDE	SOL. SAT.	S	S
HYDROCHLORIC ACID	>30	S	S				



ts = Without corrosion L = Limited corrosion NS = Corrosion

For special applications it is recommended to contact the REDI Technical Department.

Single socket pipe M/F

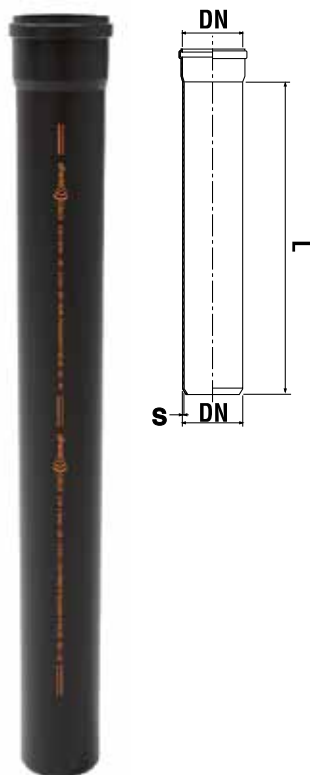
Tube M/F - Tubo M/H



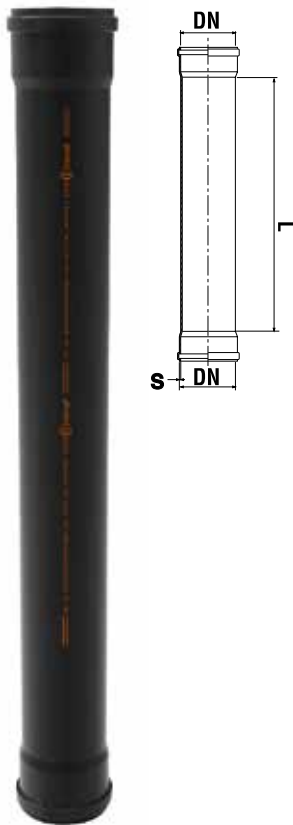

DN (mm)	L (m.)	S (mm)	Reference			Note
40	0,50	3	V0504P8	20	20	
40	1,00	3	V0104P8	20	20	
40	2,00	3	V0204P8	20	20	
40	3,00	3	V0304P8	20	20	
50	0,50	3	V0505P8	20	20	
50	1,00	3	V0105P8	20	20	
50	2,00	3	V0205P8	20	20	
50	3,00	3	V0305P8	20	20	
75	0,50	3	V0575P8	10	10	
75	1,00	3	V0175P8	10	10	
75	2,00	3	V0275P8	10	10	
75	3,00	3	V0375P8	10	10	
90	0,50	3	V0509P8	10	10	
90	1,00	3	V0109P8	10	10	
90	2,00	3	V0209P8	10	10	
90	3,00	3	V0309P8	10	10	
100	0,50	3	V0510P8	10	10	
100	1,00	3	V0110P8	10	10	
100	2,00	3	V0210P8	10	10	
100	3,00	3	V0310P8	10	10	
110	0,50	3.2	V0511P8	10	10	
110	1,00	3.2	V0111P8	10	10	
110	2,00	3.2	V0211P8	10	10	
110	3,00	3.2	V0311P8	10	10	
125	0,50	3.2	V0512P8	8	8	
125	1,00	3.2	V0112P8	8	8	
125	2,00	3.2	V0212P8	8	8	
125	3,00	3.2	V0312P8	8	8	
160	0,50	4	V0516P8	6	6	
160	1,00	4	V0116P8	6	6	
160	2,00	4	V0216P8	6	6	
160	3,00	4	V0316P8	6	6	



Double socket pipe F/F

Tube F/F - Tubo de doble embocadura H/H

DN (mm)	L (m.)	S (mm)	Reference			Note
40	0,50	3	VF504P8	20	20	
40	1,00	3	VF104P8	20	20	
40	2,00	3	VF204P8	20	20	
40	3,00	3	VF304P8	20	20	
50	0,50	3	VF505P8	20	20	
50	1,00	3	VF105P8	20	20	
50	2,00	3	VF205P8	20	20	
50	3,00	3	VF305P8	20	20	
75	0,50	3	VF575P8	10	10	
75	1,00	3	VF175P8	10	10	
75	2,00	3	VF275P8	10	10	
75	3,00	3	VF375P8	10	10	
90	0,50	3	VF509P8	10	10	
90	1,00	3	VF109P8	10	10	
90	2,00	3	VF209P8	10	10	
90	3,00	3	VF309P8	10	10	
100	0,50	3	VF510P8	10	10	
100	1,00	3	VF110P8	10	10	
100	2,00	3	VF210P8	10	10	
100	3,00	3	VF310P8	10	10	
110	0,50	3.2	VF511P8	10	10	
110	1,00	3.2	VF111P8	10	10	
110	2,00	3.2	VF211P8	10	10	
110	3,00	3.2	VF311P8	10	10	
125	0,50	3.2	VF512P8	8	8	
125	1,00	3.2	VF112P8	8	8	
125	2,00	3.2	VF212P8	8	8	
125	3,00	3.2	VF312P8	8	8	

Acoustic pipe insulation

Gaine d'isolation phonique - Funda de aislamiento acústico



DN (mm)	DN Pipe (mm)	Reference			S Thick.	Note
80	75 - 80 - 90	CD08500	6	12	5	15 metre-roll
110	100 - 110	CD11500	5	10	5	15 metre-roll
110	100 - 110	CD11100	5	-	10	15 metre-roll

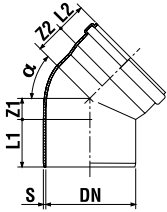

Bend 15° M/F

Coude 15° M/F - Codo 15° M/H

DN (mm)	Reference			S (mm)	Z1 (mm)	Z2 (mm)	L1 (mm)	L2 (mm)	Note
40	01004P8	25	2.025	3	3	27	48	41	
50	01005P8	15	1.215	3	4	17	53	45	
75	01007P8	8	648	3	5	18	50	45	
• 90	01009P8	5	260	5.1	11	14	59	55.7	
110	01011P8	5	260	3.2	9	22	62	57	
125	01012P8	4	208	3.2	10	22	68	63	
160	01016P8	4	96	4.0	14	28	82	72	

• High thickness / À paroi épaisse / Alto espesor

Bend 30° M/F

Coude 30° M/F - Codo 30° M/H

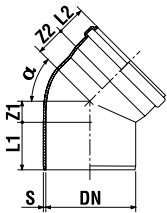

DN (mm)	Reference			S (mm)	Z1 (mm)	Z2 (mm)	L1 (mm)	L2 (mm)	Note
40	01104P8	25	2.025	3	5	19.5	49	41	
50	01105P8	15	1.215	3	8	20	53	45	
75	01107P8	8	648	3	11	24	50	45	
• 90	01109P8	5	260	5.1	17	18	59	55.7	
100	07810P8	5	260	3.2	12	20	68	56	
110	01111P8	4	208	3.2	17	29	61	57	
125	01112P8	6	144	3.2	19	29	68	62	
160	01116P8	3	72	4.0	25	40	82	72	

• High thickness / À paroi épaisse / Alto espesor

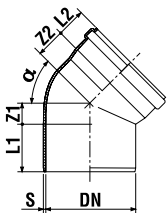

Bend 45° M/F

Coude 45° M/F - Codo 45° M/H

DN (mm)	Reference			S (mm)	Z1 (mm)	Z2 (mm)	L1 (mm)	L2 (mm)	Note
40	07004P8	30	2.430	3	8	22	48	36	
50	07005P8	20	1.620	3	10	24	52	40	
75	07307P8	10	520	3.2	16	25	52	45	
90	01209P8	5	260	3	23	33	56	54	
100	07010P8	10	240	3	20	35	62	53	
110	01211P8	4	208	3.2	27	39	58	50	
125	07012P8	6	144	3.2	29	42	68	62	
160	07016P8	3	72	4.0	37	50	80	66	

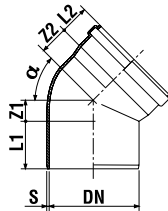
Bend 67°30' M/F**Coude 67°30' M/F - Codo 67°30' M/H**

DN (mm)	Reference			S (mm)	Z1 (mm)	Z2 (mm)	L1 (mm)	L2 (mm)	Note
75	01307P8	9	468	3	25	40	60	51	
• 90	01309P8	5	260	5.1	36	42	59	55,7	
100	07210P8	3	156	3.2	33	53	75	57	
110	01311P8	6	144	3.2	41	53	62	56	
125	01312P8	6	144	3.2	46	60	69	62	
160	01316P8	2	48	4.0	60	74	82	74	

• High thickness / À paroi épaisse / Alto espesor

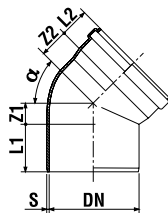
Bend 87° M/F**Coude 87° M/F - Codo 87° M/H**

DN (mm)	Reference			S (mm)	Z1 (mm)	Z2 (mm)	L1 (mm)	L2 (mm)	Note
40	07104P8	30	2.430	3	20	32	43	36	
50	07105P8	20	1.040	3	23	40	53	40	
75	07407P8	9	468	3.2	52	58	50	45	
90	07109P8	5	260	3	47	57	56	54	
100	07110P8	10	240	3	47	63	63	55	
110	07111P8	3	156	3.2	59	69	58	50	
125	07112P8	5	120	3.2	67	79	69	62	
160	07116P8	2	48	4.0	84	100	80	66	

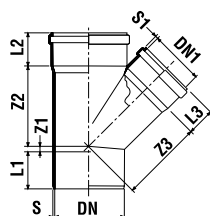
Branch 45° M/F**Culotte 45° M/F - Derivación 45° M/H**

DN/DN1 (mm)	Reference			S (mm)	S1 (mm)	Z1 (mm)	Z2 (mm)	Z3 (mm)	L1 (mm)	L2 (mm)
40/40	08004P8	20	1.040	3	3	9	52	52	49	45
50/50	08005P8	10	520	3.2	3.2	14	70	70	48	40
75/50	03127P8	6	312	3.2	3.2	-	85	-	42	45
75/75	08807P8	4	208	3.2	3.2	15	93	93	51	45
• 90/50	03128P8	5	260	5,5	3	10	77	100	53	53
90/90	08809P8	6	144	3	22	119	119	56	54	54
100/40	08310P8	10	240	3	3	-20	84	95	84	60
100/50	08330P8	3	156	3	3	-14	90	101	72	60
100/100	08810P8	6	144	3.2	3.2	25	131	131	60	53
110/50	03131P8	6	144	3.2	3.2	-14	102	114	63	55
110/75	03151P8	6	144	3.2	3.2	3	120	127	63	55
110/110	03011P8	4	96	3.2	-	27	143	143	58	50
125/110	03192P8	2	48	3.2	3.2	19	147	152	69	62
125/125	08012P8	2	48	3.2	-	30	161	161	71	62
160/110	03116P8	2	48	4.0	3.2	2	168	176	82	74
160/160	03016P8	4	32	4.0	-	38	205	205	83	71

• High thickness / À paroi épaisse / Alto espesor

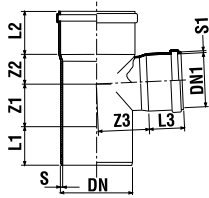

◆ Ref. 08913P8

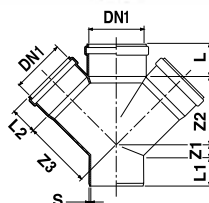
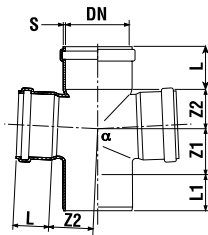

Branch 87°30' M/F

Culotte 87°30' M/F - Derivación 87°30' M/H

DN/DN1 (mm)	Ref.			S (mm)	S1 (mm)	Z1 (mm)	Z2 (mm)	Z3 (mm)	L1 (mm)	L2 (mm)
40/40	08104P8	15	1.215	3.2	3.2	25	33	33	44	36
50/50	08105P8	14	728	3.2	3.2	29	38	38	48	40
75/40	03507P8	4	324	3.2	3.2	25	35	50	48	45
75/50	03527P8	6	312	3.2	3.2	30	40	52	53	45
75/75	08907P8	5	260	3.2	3.2	37	39	58	66	50
● 90/50	03528P8	5	260	5,5	3	39	31	47	53	53
● 90/90	03409P8	5	120	5.1	4.5	49	51	51	59	55.7
100/50	08430P8	10	240	3.2	2.8	23	44	63	65	53
100/100	08110P8	5	120	3.2	3.2	55	64	64	55	53
110/50	03531P8	6	144	3.2	3.2	30	40	70	63	55
110/75	03571P8	6	144	3.2	3.2	43	54	70	63	55
◆ 110/110	08913P8	5	120	3.2	2.9	146	62	57.5	57.5	95.5
125/110	03572P8	4	96	3.2	3.0	84	58	92	78	77
125/125	08112P8	3	72	3.2	3.2	66	70	78	62	62
160/110	03516P8	10	80	4.0	3.2	59	69	37	81	74
160/160	08116P8	5	40	4.0	-	76	98	98	88	74

● High thickness / À paroi épaisse / Alto espesor

◆ Long radius

Double Branch 87°30' M/F

Té double 87°30' M/F - Derivación doble 87°30' M/H

DN (mm)	Reference			α	S (mm)	Z1 (mm)	Z2 (mm)	L1 (mm)	L2 (mm)	Note
110/110	03811P8	2	48	87°30'	3.2	62	70	70	80	

Double Branch 45° M/F

Culotte double 45° M/F - Derivación doble 45° M/H

DN/DN1/DN1 (mm)	Ref.			S (mm)	Z1 (mm)	Z2 (mm)	Z3 (mm)	L (mm)	L1 (mm)
100/40/40	04150P8	2	104	3	-20	93	105	60	75
100/50/50	04149P8	2	104	3	-15	99	110	60	64
110/110/110	03611P8	2	48	3.2	30	141	141	57	60

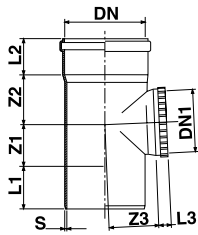

Access pipe M/F

Té de visite M/F - Te M/H con boca de registro

DN (mm)	Reference			S (mm)	Z1 (mm)	Z2 (mm)	Z3 (mm)	L1 (mm)	L2 (mm)
75	18207P8	6	312	3.2	37	39	58	66	50
100	18210P8	6	144	3.2	55	64	64	55	53
110	18211P8	6	144	3.0	59	69	69	60	55
125	18212P8	2	104	3.2	66	70	78	62	62
160	18216P8	2	48	4.0	83	99	99	85	72

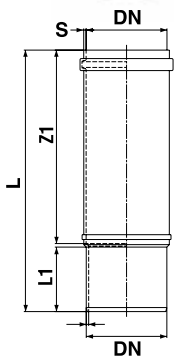

Repairing coupler

Manchon de réparation - Manguito de reparación

DN (mm)	Reference			S (mm)	L1 (mm)	Z1 (mm)	L (mm)	Note
100	02910P8	5	170	3	80	240	324,4	
125	02912P8	5	110	3	80	240	324,4	

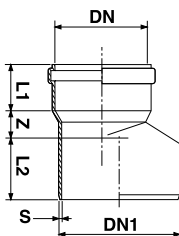

Excentrée

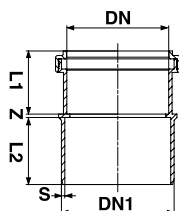

** Centrée

Invert Reducer M/F

Réduction excentrée M/F - Ampliación excéntrica M/H

DN/DN1 (mm)	Reference			S (mm)	Z (mm)	L1 (mm)	L2 (mm)	Note
40/50	09005P8	25	2.025	3.2	22	42	48	
40/100	09048P8	10	520	3	48	42	58	
50/75	05107P8	15	1.215	3	30	45	48	
50/100	09010P8	8	648	3.2	45	45	61	
50/110	05111P8	6	486	3	51	45	70	
75/100	05033P8	6	486	3	31	50	61	
75/110	05131P8	6	486	3.2	35	45	63	
90/100	05310P8**	5	405	3	3	56	59,5	
90/110	05311P8**	5	260	3	3	56	63,5	
100/110	05331P8**	6	486	3	3	60	61	
100/125	09012P8	4	208	3	16	57	61	
110/125	05132P8	4	324	3.2	22	56	63	
110/160	05116P8	6	144	4.0	43	56	82	
110/160	0686348**	16	384	-	-	-	-	
125/160	05136P8	6	144	4.0	36	62	82	

** Centrée / Excentrée / Concéntrico

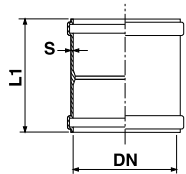
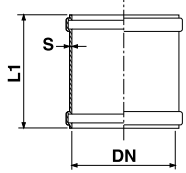

Repair/Slip coupler F/F

Manchon coulissant F/F - Manguito H/H

DN (mm)	Reference			S (mm)	L1 (mm)	Note
40	06144P8	30	2.430	2.2	57	
50	06145P8	20	1.620	2.2	67	
75	06107P8	10	810	2.5	92	
90	06109P8	6	312	2.5	104	
100	06110P8	5	260	2.5	116	
110	06111P8	4	208	2.9	122	
125	06112P8	4	208	2.9	141	
160	06116P8	4	96	3.6	154	
40	06344P8	40	2.080	-	57	with central stop / avec butée / con tope
50	06345P8	20	1.620	-	67	with central stop / avec butée / con tope
75	06307P8	10	810	2.5	92	with central stop / avec butée / con tope
90	06309P8	6	312	2.5	104	with central stop / avec butée / con tope
100	06310P8	5	260	2.5	116	with central stop / avec butée / con tope
110	06311P8	4	208	2.9	122	with central stop / avec butée / con tope
125	06312P8	4	208	2.9	68	with central stop / avec butée / con tope
160	06316P8	4	96	4.4	141	with central stop / avec butée / con tope

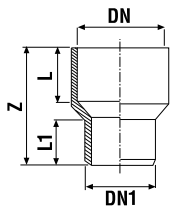

Technical coupling M/F

Manchon pour raccords multi-matériaux M/F

Manguito técnico M/H

DN (mm)	DN1 (mm)	Reference			L (mm)	L1 (mm)	Z (mm)	Note
50	40	09305P8	50	2.600	31,5	26,5	67,5	

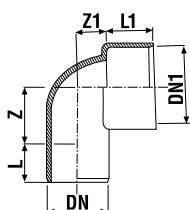

Technical bend (with protection plug) M/F

Coude (avec tampon de protection) M/F

Codo técnico M/H (con tapa protectora)

DN (mm)	DN1 (mm)	Reference			L (mm)	L1 (mm)	Z (mm)	Z1 (mm)	Note
40	50	07424P8	20	1.620	62	70	70	-	



Technical bend long version M/F
Coude long (avec tampon de protection) M/F
Codo técnico largo M/H (con tapa protectora)

DN (mm)	DN1 (mm)	Reference			L1 (mm)	Z (mm)	Z1 (mm)	Note
40	50	07454P8	20	1.040	33	150	17	

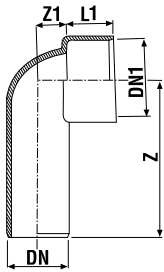

Gasket
Joint - Junta de goma

DN (mm)	DN1 (mm)	DN2 (mm)	Reference			L (mm)	Note
50	1"	55	6820502	50	6000	19	
50	1" 1/4	56	6820500	50	6000	19	
50	1" 1/2	55	6820501	50	6000	19	

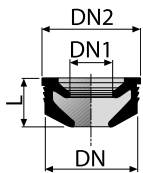

1" = 26 mm. 1"1/4 = 32 mm. 1"1/2 = 40 mm.



Floor gullies whit multiple inlets
Siphonnette a entrée multiples
Bote sifónico 3 entradas 1 salida

D (mm)	DN 3 inlets	DN1 1 inlet	Reference			h (mm)	h1 (mm)	h2 (mm)	Material
100	40	40	Z9511P8	20	160	200	30	80	PP

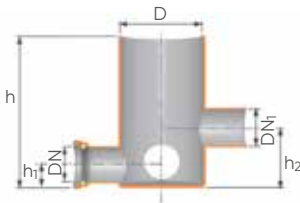

Plug for floor gully with stainless steel plate
Bouchon pour collecteur avec tournette en acier inox
Tapa bote sifónico con embellecedor acero inoxidable

DN (mm)	Reference			D (mm)	h (mm)	h1 (mm)	h2 (mm)	Note
100	Z7450PP	20	1.040	135	3	19	44,9	

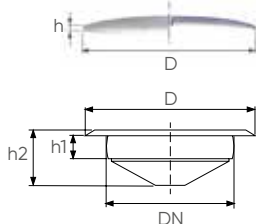

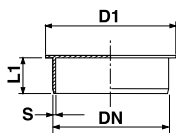

Socket plug

Bouchon de fermeture - Tapón

DN (mm)	Reference			D1 (mm)	S (mm)	L1 (mm)	Note
40	06604P8	10	10.400	45	2.5	18	
50	06605P8	10	7.800	55	2.5	20	
75	06507P8**	10	810	80	2.5	39	
90	06509P8**	8	648	125	3	52	
100	06699P8	15	1.215	125	3	56	
110	06611P8	10	810	126	3.2	38	
125	06612P8	8	648	142	3.2	42	
160	06616P8	4	324	180	4.0	49	

**Screwing version / *Vérsion à visser* / *Versión roscada*

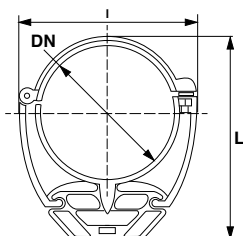

PHONOKLIP

Acoustic brackets

Collier coulissant isophonique

Abrazadera acústica

DN (mm)	Reference			Filetto Ø	L (mm)	I (mm)	Note
50	PHONK50	10	-	M8	76	78	
75	PHONK75	10	-	M8	112	111	
90	PHONK90	10	-	M8	144	131	
100	PHONK10	10	-	M7	160	140	Screws M7
110	PHONK11	10	-	M8	171	150	
125	PHONK12	2	-	M10	213	170	
160	PHONK16	2	-	M10	245	213	

PVC-U Soil & Waste System

REDI

1.2 PVC-U SOIL & WASTE



**EN 1329 Solvent Welded PVC-U Fittings
ME Type
B s2 d0 Fire Reaction Euroclass**

alixis

PVC-U

Soil & Waste System

REDI PVC-U solvent welded fittings are compliant to the EN1329 ("Plastics piping systems for soil and waste discharge, low and high temperature, within the building structure - Unplasticized Polyvinyl Chloride") standard and follows the ME Type French designation, corresponding to the highest level of protection against fire.

The products standard compliance guarantees the respect of the required dimensional tolerances, the designs criteria and the performances for building water drainage applications.

General characteristics of PVC

- Name: Polyvinyl Chloride
- Color: RAL 7037 - Grey
- Operation Temperature Range: 70 °C is the MAX temperature of waste water in permanent conditions. For discontinuous drainage applications as common household appliances discharge, instant peak of 95 °C are allowed.

Mechanical resistance

	Testing method	Unit of measure	Measured value*
Yield point	ISO 527	MPa	53
Tensile strength	ISO 527	MPa	43
Elongation at break	ISO 527	%	150
Modulus of elasticity	ISO 527	MPa	≥ 3,000

Physical properties

	Testing method	Unit of measure	Measured value*
•Average density	ISO 1183	g/cm ³	1.43
•Softening temperature (VICAT)	EN 727	°C	80
•Coefficient of linear thermal expansion		mm/m x °C	0.07
•Thermal conductivity		W/m x °C	0.16
•Surface electrical resistivity		Ω	> 10 ¹²

- Resistance to decay: PVC is completely resistant to decay.
- Biological resistance: algae and bacteria present in the waste water do not have any effect on the PVC pipes.
- The PVC is not affected by rodents.
- Abrasion resistance: the pipes and fittings conforming to EN1329 standard are abrasion-proof.
- Hydraulic roughness: the internal surfaces of the pipes and fittings conforming to EN1329 standard are hydraulically smooth. REDI couplings and fittings are designed to ensure good hydraulic performance. For flow rate calculations on PVC branches, an effective roughness coefficient can be used (k = 0.25 mm).
- For flow rate calculations on PVC branches, an effective roughness coefficient can be used k = 0.25 mm. (See installation guide).
- Chemical resistance: PVC is particularly resistant to chemical attacks and can therefore be used without problems for the drainage of industrial water containing chemical compounds in the pH range between 2 (acid) and 12 (alkaline).

PVC is also one of the few plastic materials that can be joined with solvent socket, which simplifies and speeds up many installation operations.

In the following page, a summarising table contains information obtained from laboratory tests.

Fire Reaction

- Regarding building materials applications, the fire reaction and resistance assessment is a key point to consider during the different designs and project phases. PVC is a fire-proof polymer and shows a better resistant behavior than the other traditional plastic materials.

REDI PVC fittings are certified as B S2 d0 Fire Reaction Euroclass applied to plastic material made soil and waste drainage systems.

"B" letter refers to a fire reaction range starting from A1, A2, B, C, D, E, F where the performances decrease progressively from class A1 (non-flammable, as gres or concrete) to class F (non-classifiable, the most dangerous one). PVC has a very limited contribution to fire.

"S2" letter characterizes the release attitude of smoke.

"d0" letter characterizes the release attitude of fire droplets. This kind of event may be able to spread a fire, particularly starting from a floor to another. PVC does not release any droplets.

REDI PVC Fittings also guarantee a minimum expansion capacity equal to 800 times of the wall thickness (800% minimum expansion) when heat stress occurs. This product characteristic enables the pipe or fitting cross-section to be obstructed during the fire event and consequently avoiding the flame spreading.

The oxygen level contained into the different building material formulations may influence their fire attitude during the event.

The higher is the oxygen level, the higher is the material's fire resistance. PVC has the higher level of oxygen compared to the other common used for drainage applications.

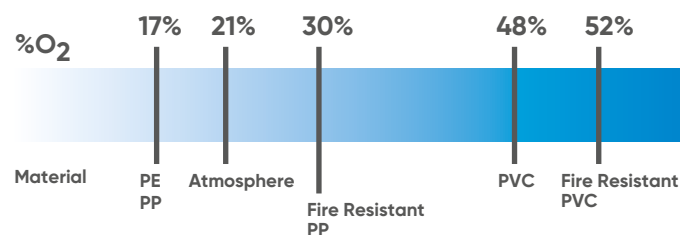

PVC – Chemical resistance

Product	Conc. %	Temp. 20 °C	Temp. 60 °C	Product	Conc. %	Temp. 20°	Temp. 60°
ACETIC ACID	60	S	L	HYDROFLUORIC ACID	60	L	NS
ACETIC ACID MONOCHLORIDE	SOL.	S	L	HYDROGEN	100	S	S
ACETIC ALDEHYDE	100	NS	-	HYDROGEN DIOXIDE	30	S	S
ACETIC ANHYDRIDE	100	NS	NS	HYDROGEN SULPHIDE	100	S	S
ACETONE	100	NS	NS	IRON CHLORIDE	SOL. SAT.	S	S
ADIPIC ACID	SOL.SAT.	S	L	LACTIC ACID	10	S	L
ALLYL ALCOHOL	90	L	S	LACTIC ACID	10-90	L	NS
ALUMINUM CHLORIDE	SOL. SAT.	S	S	LEAD ACETATE	SOL. SAT.	S	S
ALUMINUM SULPHATE	SOL. SAT.	S	S	LEAD TETRAETHYL	100	S	-
AMMONIA (AQUEOUS)	100	L	NS	MAGNESIUM CHLORIDE	SOL. SAT.	S	S
AMMONIA (GAS)	100	S	S	MAGNESIUM SULPHIDE	SOL. SAT.	S	S
AMMONIA (SOLUTION)	SOL. DIL.	S	L	MALEIC ACID	SOL. SAT.	S	L
AMMONIUM CHLORIDE	SOL. SAT.	S	S	METHYL ALCOHOL	100	S	L
AMMONIUM FLUORIDE	20	S	L	METHYL METHACRYLATE	100	NS	NS
AMMONIUM NITRATE	SOL. SAT.	S	S	METHYLENE CHLORIDE	100	NS	NS
AMMONIUM SULPHATE	SOL. SAT.	S	S	MILK		S	S
AMYL ACETATE	100	NS	NS	NICKEL SULPHIDE	SOL. SAT.	S	S
AMYL ALCOHOL	100	S	L	NICOTINIC ACID	CONC.	S	S
ANILINE	100	NS	NS	NITRIC ACID	<46	S	L
ANILINE	SOL. SAT.	NS	NS	NITRIC ACID	46-98	NS	NS
ANILINE HYDROCHLORIDE	SOL. SAT.	NS	NS	OILS		S	S
ANTIMONY CHLORIDE	90	S	S	OLEIC ACID	100	S	S
ARSENIC ACID	SOL. DIL.	S	-	OLEUM	10% of SO	NS	NS
BEER		S	S	OXALIC ACID	SOL. DIL.	S	L
BENZALDEHYDE	0,1	NS	NS	OXALIC ACID	SOL. SAT.	S	S
BENZENE	100	NS	NS	OXIGEN	100	S	S
BENZOIC ACID	SOL. SAT.	L	NS	OZONE	100	NS	NS
BORAX	SOL. SAT.	S	L	PERCHLORIC ACID	10	S	L
BORIC ACID	SOL. DIL.	S	L	PERCHLORIC ACID	70	L	NS
BROMINE (LIQUID)	100	NS	NS	PETROL	80/20	NS	NS
BROMINE ACID	10	S	-	PHENOL	90	NS	NS
BUTADIENE	100	S	S	PHOSPHINE	100	S	S
BUTANE	100	S	-	PHOSPHOR TRICHLORIDE	100	NS	-
BUTYL ACETATE	100	NS	NS	PHOSPHORIC ACID	30	S	L
BUTYL PHENOL	100	NS	NS	PICRIC ACID	SOL. SAT.	S	S
BUTYLENE	100	S	L	POTASSIUM BICHROMATE	40	S	S
BUTYRIC ACID	20	S	L	POTASSIUM BROMIDE	SOL. SAT.	S	S
BUTYRIC ACID	98	NS	NS	POTASSIUM CHLORIDE	SOL. SAT.	S	S
CALCIUM CHLORIDE	SOL. SAT.	S	S	POTASSIUM CHROMATE	40	S	S
CALCIUM NITRATE	50	S	S	POTASSIUM CYANIDE	SOL.	S	S
CARBON DIOXIDE	100	S	S	POTASSIUM FERRICYANIDE	SOL. SAT.	S	S
CARBON SULPHIDE	100	NS	NS	POTASSIUM FERROCYANIDE	SOL. SAT.	S	S
CARBON TETRACHLORIDE	100	NS	NS	POTASSIUM HYDROXIDE	SOL.	S	S
CETYL ACID	100	S	S	POTASSIUM NITRATE	SOL. SAT.	S	S
CHLORINE (DRY GAS)	100	L	NS	POTASSIUM PERMANGANATE	20	S	S
CHLORINE (LIQUID)	SOL. SAT.	L	NS	POTASSIUM PERSULFATE	SOL. SAT.	S	L
CHLOROSULPHONIC ACID	100	L	NS	PROPANE (GAS LIQUID)	100	S	-
CHROMIC ACID	1-50	S	L	PYRIDINE	100	NS	-
CITRIC ACID	SOL. SAT.	S	S	SEA WATER		S	L
COPPER CHLORIDE	SOL. SAT.	S	S	SILVER NITRATE	SOL. SAT.	S	L
COPPER FLUORIDE	2	S	S	SOAP	SOL.	S	L
CREOSOL	SOL. SAT.	-	NS	SODIUM BENZOATE	35	S	L
CRESOL ACID	SOL. SAT.	NS	NS	SODIUM BISULPHITE	SOL. SAT.	S	S
CROTONIC ALDEHYDE	100	NS	NS	SODIUM CHLORATE	SOL. SAT.	S	S
CYCLOHEXANOL	100	NS	NS	SODIUM FERRICYANIDE	SOL. SAT.	S	S
CYCLOHEXANONE	100	NS	NS	SODIUM HYDROXIDE	SOL.	S	L
DEVELOPING BATH		S	S	SODIUM HYPOCHLORITE	100 (13% CL.)	S	L
DEXTRINE	SOL. SAT.	S	L	SODIUM SULPHITE	SOL. SAT.	S	L
DICHLOROETHYLENE	100	NS	NS	SUGAR	SOL. SAT.	S	S
DIGLYCOLIC ACID	18	S	L	SULPHUR ACID	SOL.	S	S
DIMETHYLAMMINE	30	S	-	SULPHUR ANHYDRIDE	100 (LIQUID)	L	NS
ETHYL ACETATE	100	NS	NS	SULPHUR ANHYDRIDE	100 (DRY)	L	NS
ETHYL ACRYLATE	100	NS	NS	SULPHURIC ACID	40-90	S	L
ETHYL ALCOHOL	95	S	L	SULPHURIC ACID	96	L	NS
ETHYL ETHER	100	NS	L	TANNIC ACID	SOL.	S	S
ETHYLENE GLYCOL	CONC.	L	L	TARTARIC ACID	SOL.	S	S
FLUOSILICIC ACID	32	S	S	TIN CHLORIDE	SOL. SAT.	S	S
FORMALDEHYDE	SOL.	S	S	TOLUENE	100	NS	NS
FORMALDEHYDE	40	S	S	TRICHLOROETHYLENE	100	NS	NS
FORMIC ACID	1-50	S	L	TRIMETHYL PROPANE	<10	S	L
FURFURAL ALCOHOL	100	NS	NS	UREA	10	S	L
GLUCOSE	SOL. SAT.	S	L	URINE		S	L
GLYCERIN	100	S	S	VINAGRE		S	S
GLYCOLIC ACID	30	S	S	VINYL ACETATE	100	NS	NS
GOLDEN SYRUP	SOL.	S	L	WINE		S	S
HYDRAZINE BENZENE	100	NS	NS	XYLENE	100	NS	NS
HYDRAZINE BENZENE CLORIC	97	NS	NS	YEAST	SOL.	S	L
HYDROBROMIC ACID	50	S	L	ZINC CHLORIDE	SOL. SAT.	S	S
HYDROCHLORIC ACID	>30	S	S				

ts = Without corrosion L = Limited corrosion ns = Corrosion

For special applications it is recommended to contact the REDI Technical Department.

Installation Guide

Installation of the expansion joint in the PVC drainage systems:

In branches or bends, the most correct technical solution is inserting a horizontal expansion joint (A; B; C) into the piping whenever the section between two fixed points is higher than 2÷3 m, and always when connecting washing-machines, dishwashers and kitchen sinks.

A vertical expansion joint (D) should be inserted onto each level of the vertical columns above the branch that connects to the bend and the toilet bowl. Alternatively, a branch equipped with an expander (E or F) can be used to directly connect to the column.

Pict.1



Expansion joint horizontal
•A •B •C

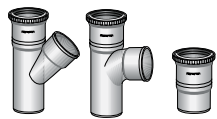
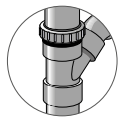

Expansion
•D •E •F

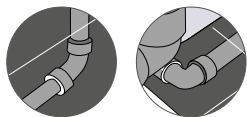

Technical bend

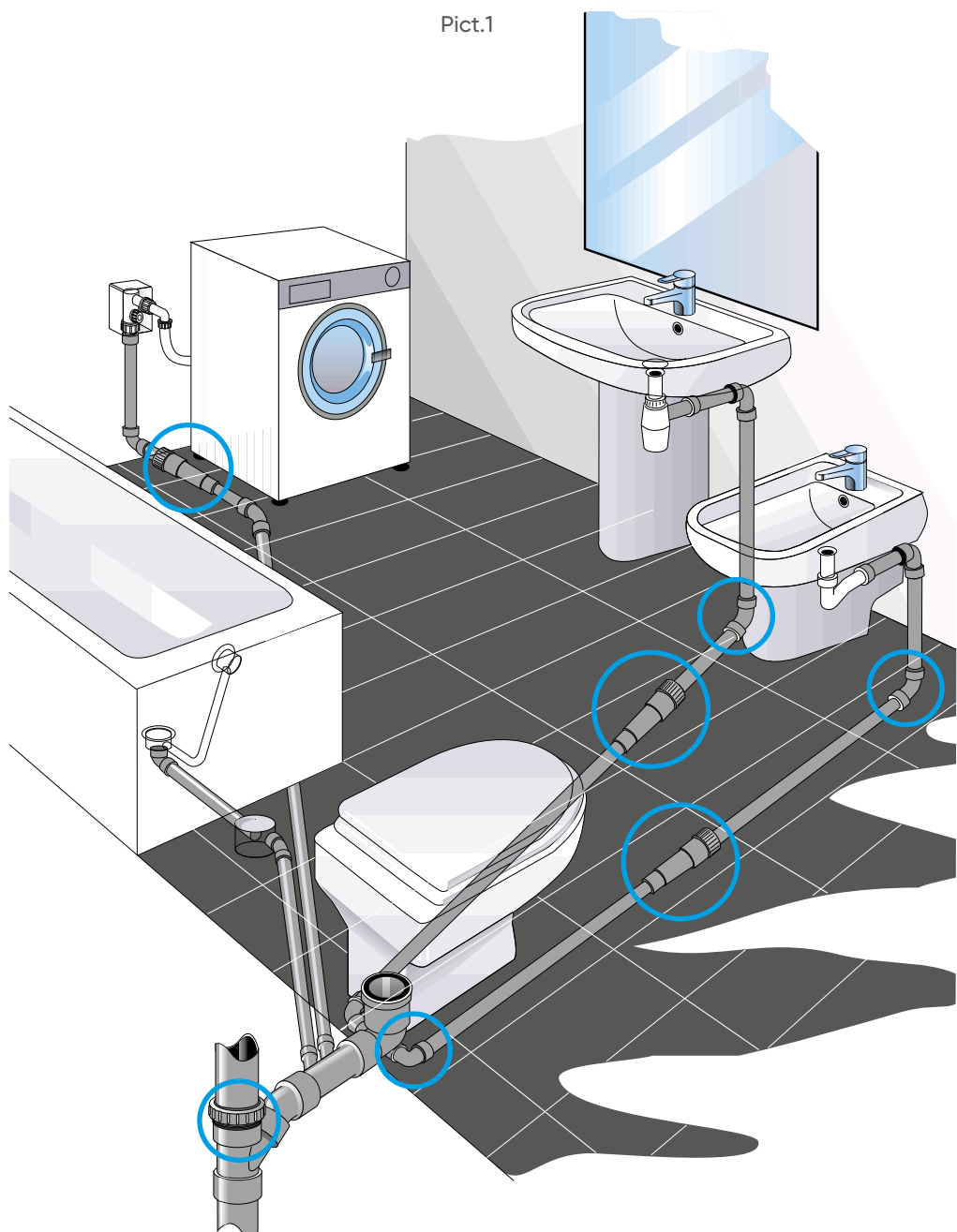

Connection to sanitary fittings:

Vertical connection to the toilet

Pict.2

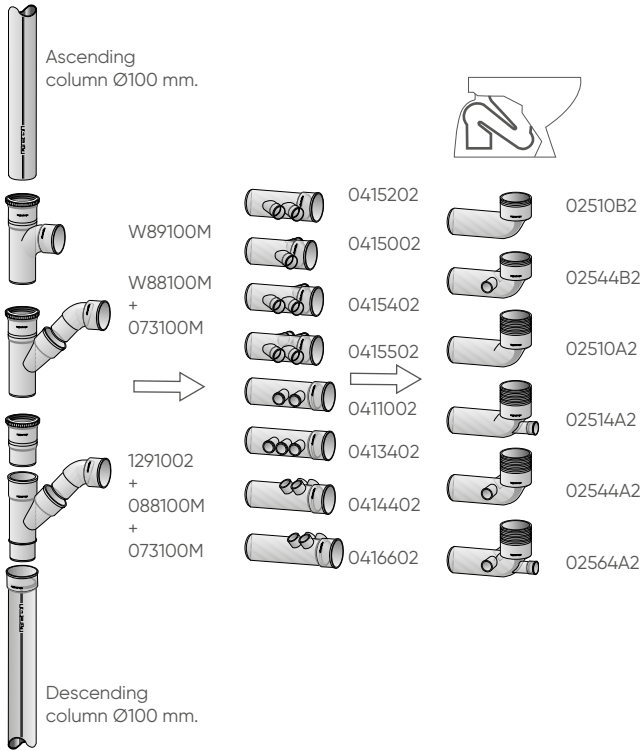

* = Product with various dimensions, in the Pict. 3 the code of the most widely used type is to be found.

Connecting elements:

Extension for toilet bend.
EVA Universal Seal with high wear and tear resistance.
Concentric and eccentric adapters.
Flat rubber seal with clamping ring.

Pict.3

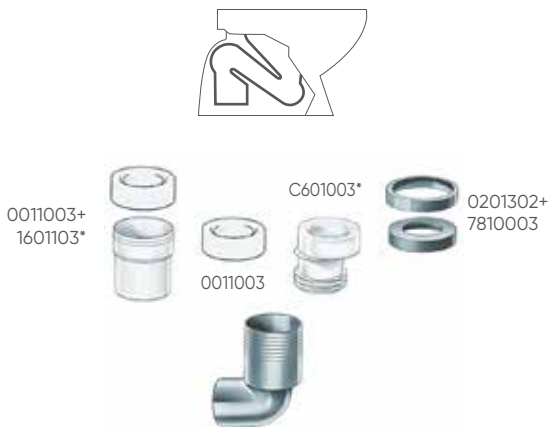

* = Product with various dimensions, in the Pict. the code of the most widely used type is to be found.

Horizontal connection to the toilet (back or suspended)

A both long and short toilet coupling is used on when the same accessories indicated in the figure below can be inserted.

Pict.3

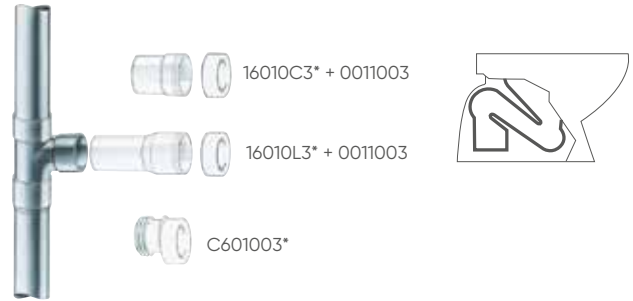

* = Product with various dimensions, in the Pict. the code of the most widely used type is to be found.

Sink/bidet connection

Technical bends: guarantee good water-tightness, maintaining compact sizes against the wall.
The same product exists also in the technical coupling version. Technical bends with ferrule.
Extended technical bend.

Pict.4

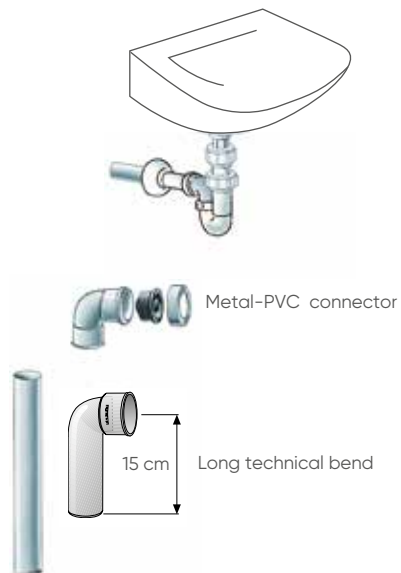

Technical bends with ferrule: guarantee greater stability of the technical seal which bears slight misalignment of the sleeve connection pipe better. This fitting needs a technical self-locking seal shaped accordingly to allow the ferrule to be assembled. This product exists also in the technical coupling version.

Bath and shower connection:

The connection of the bath drains directly to the bend with border Ø32 (026030M) with half a brass ferrule or made from 1" ¼ polypropylene.

Pict.5

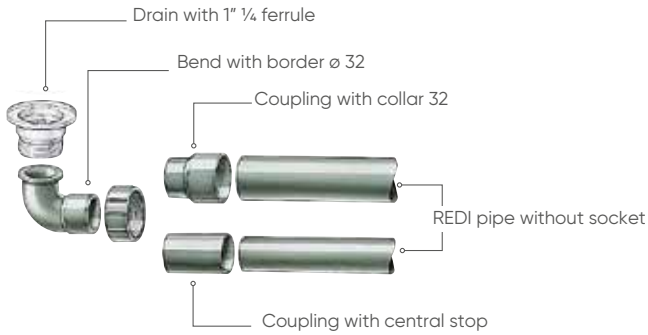

Floor trap:

Waterproofing of the surrounding area, in consideration that infiltration may occur between the walls of the trap and the floor covering: for installation refer to the exploded figure below which indicates the positioning of the necessary components:

Tap for floor trap (0661002)

Stainless steel plate (PIAOXNI)

Drain ring for PVC cloth (0201002)

PVC cloth (02; R991202)

Pict.6



Typical problems of the drainage system

The main problems which can affect the drainage system are:

- **CLOGGING** often occurs as a result of an inadequate diameter, that not allowing the regular disposal of sewage, it prevents the correct passage of the liquid which normally makes the internal self-cleaning of the walls: a reduced cross-section prevents disposal whilst an excessive cross-section causes the deposit of sediments that might lead to the gradual shrinking of the section until it is blocked. This phenomenon can also occur due to small slopes, abrupt deviations and inadequate confluence.

- **SMELL EMISSION** is another problem strictly linked to the ventilation system: the descent of sewage can cause the leakage of gases conveyed through the drain pipes of the lower floors or the emptying by suction of the drain pipes located upstream. The misplacement of the vent can cause the emission of odours into the environment: this must be at least 2 ml. above the ground floor of high houses, at least 20 cm above the roof cover and always 1 ml. above the architrave of the nearest window.

- **LINEAR EXPANSION** is a problem which affects all plastic and metal systems, depending on the coefficient of linear thermal expansion that is a given characteristic of each material. In order to assess the elongation of each single system section, the thermal expansions of different materials are compared in graph A. It is clear that, as concerns the effects of thermal expansion containment, PVC is the least subjected to changes of size which are in the range of:

- 0.07 mm each 1 ml. of pipe
- for 1 °C of heat gradient

4 ml. piping installed at 0 °C that reaches the temperature of 42 °C, is subject to an elongation of around 12 mm (e.g. upright column). However, in the case of a kitchen drain where boiling water is poured (around 90 C° for the thermal expansion which occurs inside the sink pipe) in a room temperature pipe (20 °C) on a 3 ml. length of tube it will increase in length by around 15 mm.

Pict.7

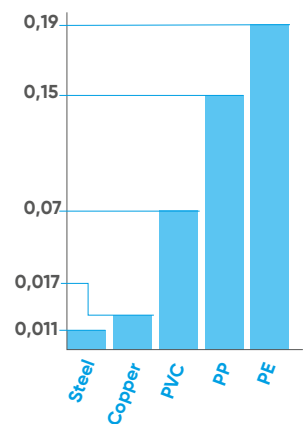

Graph A
Linear thermal expansion expressed in mm. x m. x °C

Example of expansion calculation:

T = max operating temperature (e.g. 90°C)

T1 = mounting temperature or minimum operating temperature if below (e.g 20°C)

0,07 = linear thermal expansion of PVC expressed in mm x m x °C (Pict. 7)

L = length of the section in question (e.g. 3 linear metres)

$$(T - T1) \times 0.07 \times L$$

specifically in the case under examination: (90-20) x 0.07 x 3 = 15 mm

The following general rules can be gathered from the example shown below:

- 1) in branches or bends (Pict. 9) the most correct solution is inserting a horizontal expansion joint into the piping (Pict. 8) whenever the section between two fixed points F (Pict. 9) exceeds $2 \div 3$ metres and always when connecting washing-machines and dishwashers (branches subjected to continuous discharge of hot water).

Pict.8

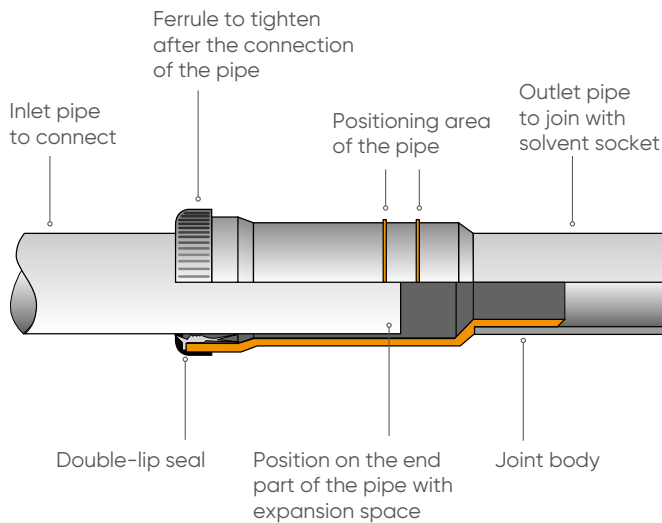

Pict.9

F = Fixed point
A = Horizontal expansion joint
B = Vertical expansion joint

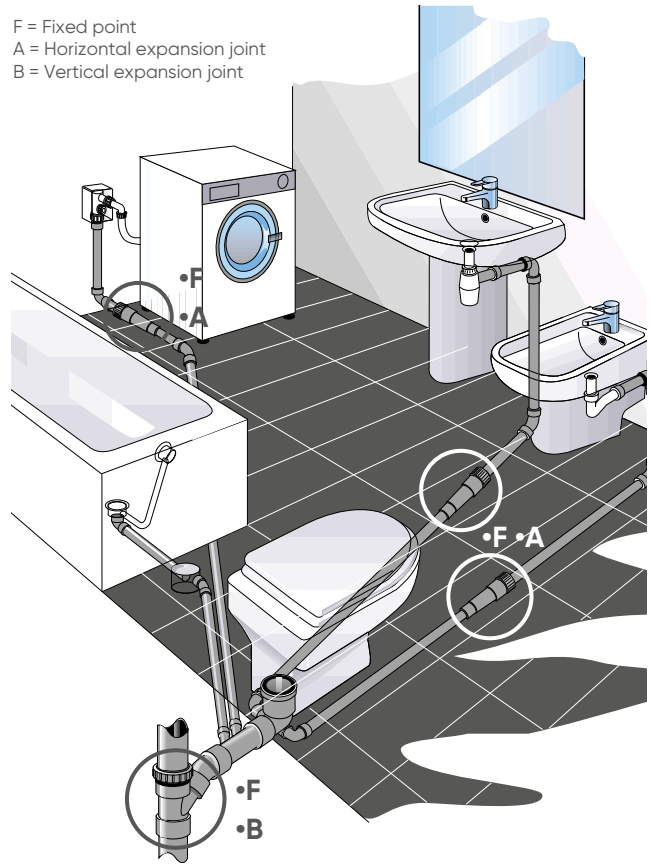

Pict.10

Vertical expansion-joint and insertion according to the mounting diagram

- 2) A vertical expansion joint should be inserted on each level (every $3 \div 4$ metres) of the upright columns above the branch which receives the bend and the toilet bowl. Alternatively, a branch equipped with an expander can be used for direct connection to the column (Pict. 10).

- 3) During the installation of the expansion joint, the following requirements must be observed:

- a) after having treated the joint seal with RED I greaser, apply also the grease to the pipe and insert it into the relative slot. Before tightening the locking ring nut, feed the pipe until it has its end part in the field marked out by two lines, superimposed on the joint body (Pict. 9).
- c) install the pipe placed behind the wall without immersing it in the cement, using for the filling of the section fine grained-stabilised material in order to allow for any adjustment caused by expansion.

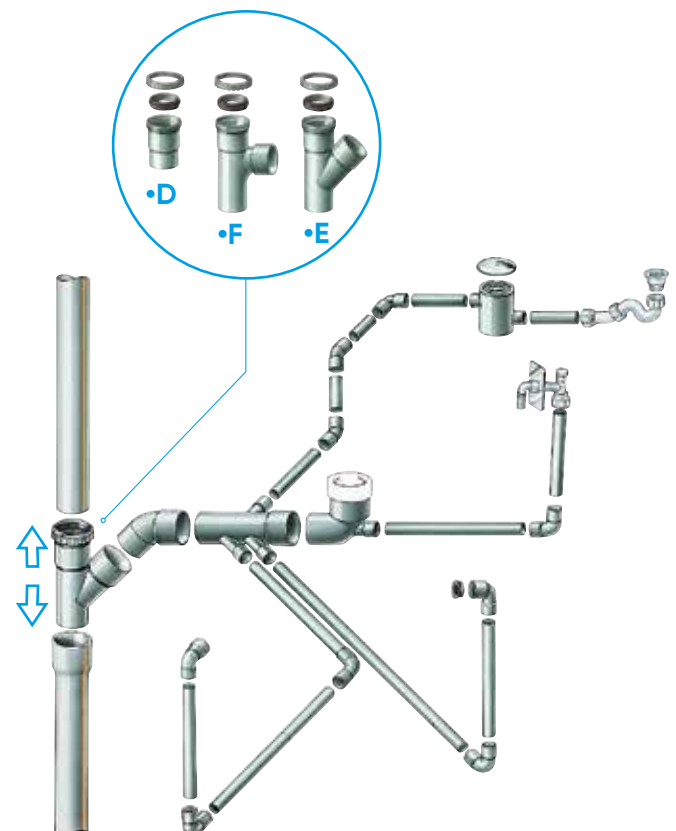

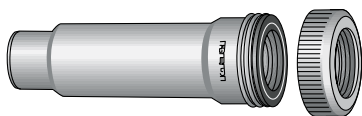



Expansion joint horizontal M/F

Manchon de dilatation horizontal M/F

Manguito de dilatación horizontal M/H

DN (mm)	Reference			Type
32	1290302	5	1.920	A (see Picture 9)
40	1290402	5	1.440	B (see Picture 9)
50	1290502	5	960	C (see Picture 9)
63	MLH00NI	32	768	
75	MPH00NI*	20	-	
80	MRH00NI	35	420	
100	MTH00NI	20	240	
110	MVH00NI	20	240	
125	MXH00NI	16	192	
160	MZH00NI	18	144	



*upon request



Expansion joint vertical M/F

Manchon de dilatation vertical M/F

Manguito de dilatación vertical M/H

DN (mm)	Reference			Type
100	1291002*	10	240	D (see Picture 10)



*upon request



Expansion branch 45° M/F

Culotte de dilatation 45° M/F

Derivación de dilatación 45° M/H

DN (mm)	Reference			Type
100	W88100M*	20	-	E (see Picture 10)



*upon request



Expansion joint vertical M/F

Manchon de dilatation vertical M/F

Manguito de dilatación vertical M/H

DN (mm)	Reference			Type
100	1291002	10	240	D (see Picture 10)

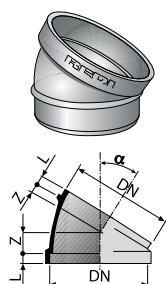

Segment Bend 15°/30° M/F

Secteur de coude 15°/30° M/F

Sector de codo 15°/30° M/H

DN (mm)	Reference			L (mm)	Z (mm)	α	Note
100	017100M	40	960	20	9	15°	
100	018100M	40	960	20	16	30°	

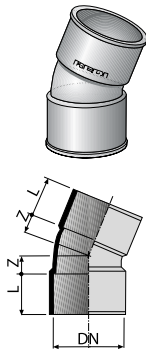

Bend Double Socket 22°30' F/F
Coude 22°30' F/F - Codo 22°30' H/H

DN (mm)	Reference			L (mm)	Z (mm)	Note
32	028030M*	100	5.200	23	5,5	
40	028040M	60	3.120	27	6,5	
50	028050M	40	2.080	32	7,5	
100	028100M	12	288	56	20	

*upon request

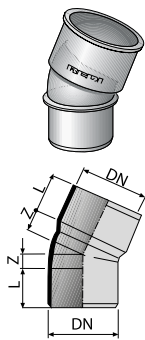

Bend 22°30' M/F
Coude 22°30' M/F - Codo 22°30' M/H

DN (mm)	Reference			L (mm)	Z (mm)	Note
32	078030M	100	5.200	23	5,5	
40	078040M	150	3.600	27	6,5	
50	078050M	40	2.080	32	7,5	
100	078100M	12	288	56	20	

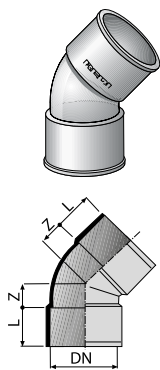

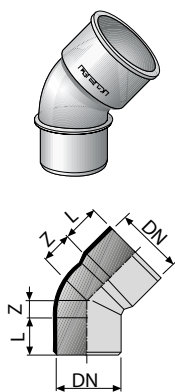

Bend Double Socket 45° F/F
Coude 45° F/F - Codo 45° H/H

DN (mm)	Reference			L (mm)	Z (mm)	Note
32	023030M	100	5.200	23	11	
40	023040M	140	3.360	27	13	
50	023050M	80	1.920	32	17	
63	023060M	45	1.080	39	22	
75	023070M	25	600	44,5	25	
80	023080M	20	480	47	26,5	
100	023100M	40	320	53	33	
110	023110M	30	240	56	38	
125	023120M	20	160	61	41	
140	023140M	15	120	61	47	
160	023160M	10	80	72	50	
200	023200M	5	40	85	65	
250	0232502	1	27	101	79	
315	0233002	1	14	116	100	



Bend 45° M/F
Coude 45° M/F - Codo 45° M/H

DN (mm)	Reference			L (mm)	Z (mm)	Note
32	073030M	100	5.200	23	11	
40	073040M	150	3.600	27	13	
50	073050M	80	1.920	32	17	
63	070060M	50	1.200	39	22	
75	073070M	25	600	44,5	25	
80	073080M	25	600	47	26,5	
100	073100M	40	320	53	33	
110	073110M	8	192	56	38	
125	073120M	20	160	61	41	
140	0121402	20	160	61	47	
160	0701602	15	120	72	50	
200	0702002	5	40	85	65	
250	0122502	1	50	101	79	
315	0123002	1	16	116	100	
400	0124002	1	7	155	125	
500	0125002*	1	4	150	160	

*upon request

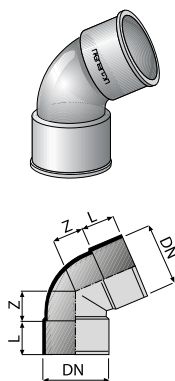



Bend Double Socket 67°30' F/F
Coude 67°30' F/F - Codo 67°30' H/H

DN (mm)	Reference			L (mm)	Z (mm)	Note
32	027030M*	50	4.050	23	18	
40	027040M*	50	2.600	27	21	
50	027050M*	60	1.440	32	27	
100	027100M*	30	240	57	53	

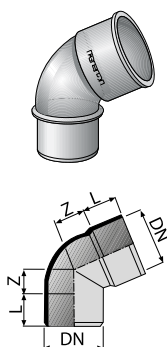
*upon request





Bend 67°30' M/F
Coude 67°30' M/F - Codo 67°30' M/H

DN (mm)	Reference			L (mm)	Z (mm)	Note
32	072030M	50	4.050	23	18	
40	072040M	50	2.600	27	21	
50	072050M*	60	1.440	32	27	
100	072100M	30	240	57	53	
125	013120M*	18	144	64	58	

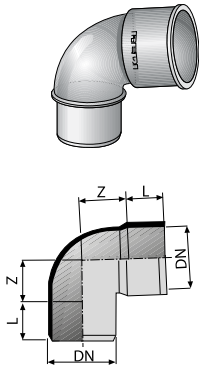

*upon request

**Bend 87°30' M/F****CoUDE 87°30' M/F - Codo 87°30' M/H**

DN (mm)	Reference			L (mm)	Z (mm)	Note
32	074030M	80	4.160	23	25	
40	074040M	100	2.400	27	31	
50	074050M	50	1.200	32	39	
63	071060M	35	840	39	48	
75	074070M	20	480	44,5	58	
80	074080M	15	360	47	61	
100	074100M	30	240	57	77	
110	0711102	25	200	61	65	
125	074120M	15	120	60	101	
140	0141402	12	96	61	83	
160	074160M	8	64	60	124	
200	074200M	5	40	60	153	
250	0142502	1	22	103	155	
315	0143002	1	10	120	192	
400	0144002	1	6	155	245	
* 110	074110M	20	160	62	87	

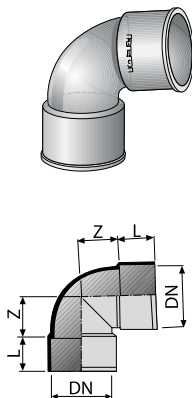
* Long radius / Grand rayon / Gran radio

**Bend Double Socket 87°30' F/F****CoUDE 87°30' F/F - Codo 87°30' H/H F/F**

DN (mm)	Reference			L (mm)	Z (mm)	Note
32	024030M	80	4.160	23	25	
40	024040M	100	2.400	27	31	
50	024050M	50	1.200	32	39	
63	024060M	30	720	39	48	
75	024070M	18	432	44,5	58	
80	024080M	15	360	47	61	
100	024100M	25	200	57	77	
110	0241302	25	200	61	65	
125	024120M	15	120	60	101	
140	E24140M	10	80	61	83	
160	024160M	8	64	60	124	
200	024200M	4	32	60	153	
250	0242502	1	20	103	155	
315	0243002	1	10	120	192	
* 110	024110M	18	144	62	245	

* Long radius / Grand rayon / Gran radio

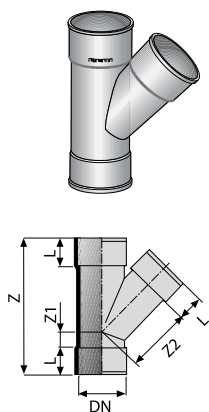

Branch Triple Socket 45° F/F
Culotte 45° F/F - Derivación 45° H/H

DN (mm)	Reference			L (mm)	Z (mm)	Z1 (mm)	Z2 (mm)	Note
32	044030M	100	2.400	23	98	11	41	
40	044040M	60	1.440	27	118	13	51	
50	044050M	30	720	32	144	17	63	
63	044060M	15	360	39	180	21	81	
75	044070M	10	240	44,5	207	25	93	
80	044080M	10	240	47	224	27	103	
100	044100M	20	160	57	271	33	124	
110	044110M	10	80	60,5	296	37	138	
125	E44120M	10	80	61	319	41	156	
140	E44140M	8	64	60	334	32	176	
160	044160M	4	32	65	387	45	203	
200	1442002	1	22	86	483	45	250	
250	1442502	1	11	103	609	57	315	
315	1443002	1	5	115	725	73	380	

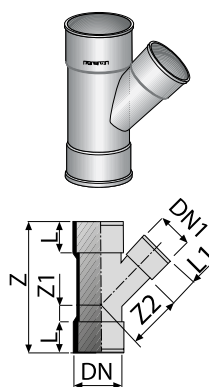

Unequal branch triple socket 45° F/F
Culotte et embranchement 45° F/F
Derivación reducida 45° H/H

DN (mm)	DN1 (mm)	Reference			L (mm)	Z (mm)	Z1 (mm)	Z2 (mm)	Note
40	32	BH244NI	10	1.920	27	106	7	46	

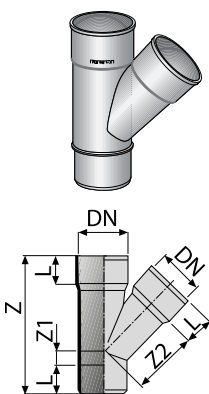

Branch 45° M/F
Culotte 45° M/F - Derivación 45° M/H

DN (mm)	Reference			L (mm)	L1 (mm)	Z (mm)	Z1 (mm)	Z2 (mm)	Note
32	088030M	50	2.600	23	-	98	11	41	
40	088040M	60	1.440	27	-	118	13	51	
50	088050M	30	720	32	-	144	17	63	
63	088060M	20	480	39	-	180	21	81	
75	088070M	10	240	44,5	-	207	25	93	
80	088080M*	8	192	47	-	224	27	103	
100	088100M	20	160	57	-	271	33	124	
110	088110M	15	120	60,5	-	296	37	138	
125	080120M	10	80	61	-	319	41	156	
140	0301402	8	64	60	-	334	32	176	
160	0301602	5	40	65	-	387	45	203	
200	0302002	1	22	86	-	483	45	250	
250	0302502	1	12	103	-	609	57	315	
315	0303002	1	5	115	-	725	73	380	

*upon request

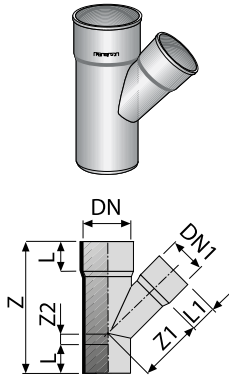

Unequal Branch 45° M/F
Culotte 45° M/F - Derivación reducida 45° M/H

DN (mm)	DN1 (mm)	Reference			L (mm)	L1 (mm)	Z (mm)	Z1 (mm)	Z2 (mm)	Note
75	50	031270M	20	480	45	40	180	87	8	
100	40	083100M	10	240	53	36	180	100	15	
100	50	083300M	10	240	53	40	193	104	8	
100	63	083500M*	10	240	56	38	208	107	3	
110	50	031310M	10	240	55	40	206	15	114	
110	75	031510M	20	160	59	45	237	1	122	
125	100	031720M	12	96	70	62	294	145	14	
125	110	031920M*	10	80	62	56	298	19	150	
160	110	0311602	1	72	72	55	325	2	175	
160	125	0313602	6	48	74	62	346	12	182	
200	110	0313502	1	48	86	56	360	17	200	
200	125	0313702*	1	40	86	60	380	7	210	
200	160	0312002	1	30	86	74	430	18	230	
250	160	0314002	1	20	103	72	482	3	260	

*upon request

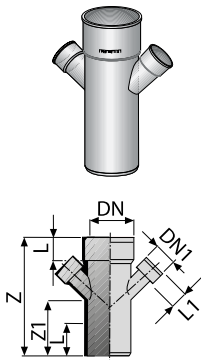

Reduced multibranch 45° M/F
Culotte multiple 45° M/F - Derivación múltiple reducida 45° M/H

DN (mm)	DN1 (mm)	Reference			L (mm)	L1 (mm)	Z (mm)	Z1 (mm)	Note
100	40	0415002*	10	180	57	27	273	145	

*upon request

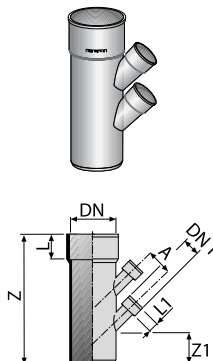

Reduced multibranch 45° M/F
Culotte multiple 45° M/F - Derivación múltiple reducida 45° M/H

DN (mm)	DN1 (mm)	Reference			L (mm)	L1 (mm)	Z (mm)	Z1 (mm)	A (mm)	Note
100	40	0415202*	10	190	57	27	273	67	55	

*upon request

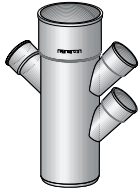

Reduced multibranch 45° M/F

Culotte multiple 45° M/F - Derivación múltiple reducida 45° M/H

DN (mm)	DN1 (mm)	Reference			L (mm)	L1 (mm)	Z (mm)	Z1 (mm)	A (mm)	Note
100	40	0415402*	10	160	57	27	273	67	55	

*upon request

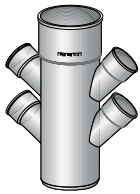
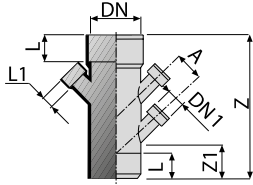

Reduced multibranch 45° M/F

Culotte multiple 45° M/F - Derivación múltiple reducida 45° M/H

DN (mm)	DN1 (mm)	Reference			L (mm)	L1 (mm)	Z (mm)	Z1 (mm)	A (mm)	Note
100	40	0415502*	20	-	57	27	273	65	55	

*upon request

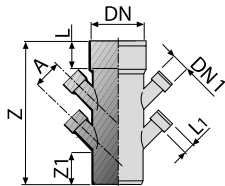

Double bend 45° M/F

Coude double 45° M/F - Codo doble 45° M/H

DN (mm)	Reference			L (mm)	Z1 (mm)	Z2 (mm)	Note
100	0421002*	10	180	64	56	28	

*upon request

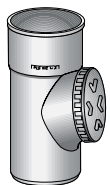
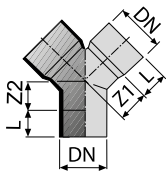

Access pipe M/F

Té de visite M/F - Té con registro M/H

DN (mm)	Reference			Z (mm)	Z1 (mm)	Z2 (mm)	Note
100	182100M*	20	160	90	243	134	
110	182110M*	20	160	95	246	119	
160	1821602	1	75	110	333	164	
315	1403002*	1	8	240	611	310	

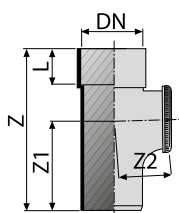

*upon request

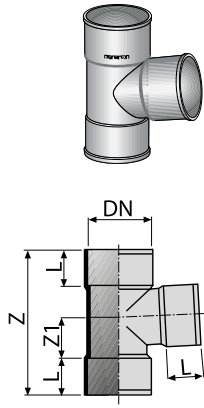



Branch triple socket 87°30' F/F

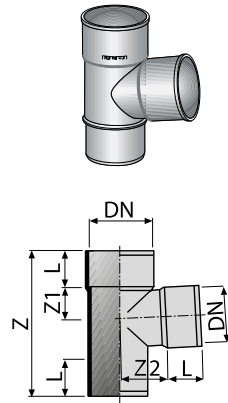

Culotte 87°30' F/F - Derivación 87°30' H/H

DN (mm)	Reference			L (mm)	Z (mm)	Z1 (mm)	Note
32	045030M	50	2.600	23	88	25	
40	045040M	70	1.680	27	106	31	
50	045050M	40	960	32	129	39	
75	045070M	15	360	44	185	58	
80	045080M	10	240	47	195	61	
100	045100M	20	160	57	243	77	
110	045110M	13	104	62	268	87	
125	E45120M	10	80	60	283	100	
160	045160M	5	40	74	335	95	
200	1452002	1	28	86	410	120	
250	1452502	1	15	103	510	152	
315	1453002	1	8	115	620	185	



Branch 87°30' M/F

Culotte 87°30' M/F - Derivación 87°30' M/H

DN (mm)	Reference			L (mm)	Z (mm)	Z1 (mm)	Z2 (mm)	Note
32	089030M*	50	2.600	23	88	17	25	
40	089040M	70	1.680	27	106	21	31	
50	089050M	40	960	32	129	26	39	
63	0810602	20	480	46	160	42	42	
75	089070M	12	288	44	185	39	58	
80	089080M	15	360	47	195	40	61	
100	089100M	20	160	56	227	44	64	
110	089110M	12	96	62	268	57	87	
125	081120M	12	96	62	275	70	70	
140	0341402	8	64	62	260	70	78	
160	0811602	6	48	74	333	95	95	
200	0342002	3	24	86	410	120	120	
250	0342502	1	18	103	510	152	152	
315	0343002	1	8	115	620	185	185	

*upon request

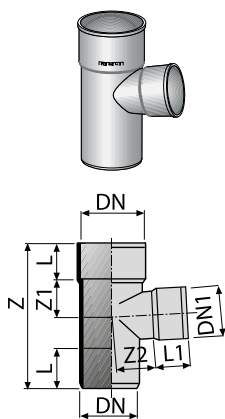

Unequal branch 87°30' M/F

Culotte 87°30' M/F - Derivación reducida 87°30' M/H

DN (mm)	DN1 (mm)	Reference			L (mm)	Z (mm)	Z1 (mm)	Z2 (mm)	Note
75	50	035270M	20	480	45	168	40	52	
100	40	0841002	8	192	53	36	170	44	
100	50	0843002*	10	240	53	40	174	44	
100	63	0845002*	10	240	53	41	175	44	
110	50	035310M	10	240	59	198	50	71	
110	75	035710M	8	192	59	210	50	71	
200	160	0352002*	1	40	86	380	110	132	

*upon request

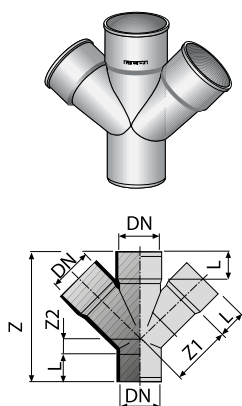

Double branch 45° M/F

**Culotte double parallèle 45° M/F
Derivación doble plana 45° M/H**

DN (mm)	Reference			L (mm)	Z (mm)	Z1 (mm)	Z2 (mm)	Note
50	0360502	50	550	40	168	69	19	
75	036070M	8	192	45	221	102	29	
100	0361002*	5	100	53	264	125	30	
110	0361102	1	96	58	289	141	32	
125	0361202	1	60	64	316	157	31	
160	0361602	1	30	72	412	201	67	

*upon request

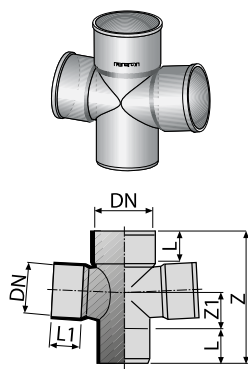

Double branch 87°30' M/F

**Culotte double parallèle 87°30' M/F
Derivación doble plana 87°30' M/H**

DN (mm)	Reference			L (mm)	Z (mm)	Z1 (mm)	Z2 (mm)	Note
75	038070M	25	200	45	221	102	29	
100	0381002*	5	105	53	264	125	30	
110	0381102	1	120	58	289	141	32	

*upon request

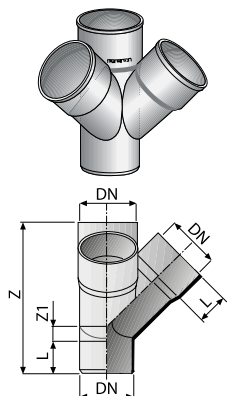

Double corner branch 45° M/F

**Culotte double d'équerre 45° M/F
Doble derivación escuadra 45° M/H**

DN (mm)	Reference			L (mm)	Z (mm)	Z1 (mm)	Note
100	U391002	5	70	50	271	40	

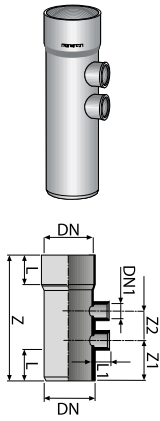

Multibranch 87°30' M/F

Culotte multiple 87°30' M/F - Derivación múltiple 87°30' M/H

DN (mm)	DN1 (mm)	Reference			L (mm)	L1 (mm)	Z (mm)	Z1 (mm)	Z2 (mm)	Note
100	40	0413302*	1	248	40	-	-	-	-	
110	50	0411102	5	120	68	42	330	110	100	

*upon request

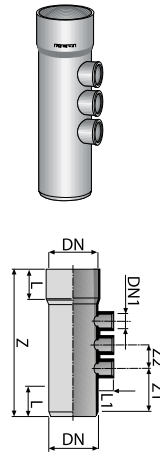

Multibranch 87°30' M/F

Culotte multiple 87°30' M/F - Derivación múltiple 87°30' M/H

DN (mm)	DN1 (mm)	Reference			L (mm)	L1 (mm)	Z (mm)	Z1 (mm)	Z2 (mm)	Note
100	40	0413402*	1	224	56	26	330	180	52	

*upon request

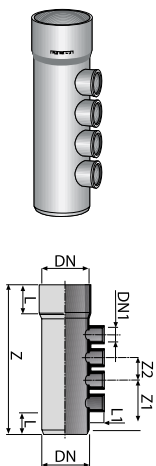

Multibranch 87°30' M/F

Culotte multiple 87°30' M/F - Derivación múltiple 87°30' M/H

DN (mm)	DN1 (mm)	Reference			L (mm)	L1 (mm)	Z (mm)	Z1 (mm)	Z2 (mm)	Note
100	40	0414702*	1	140	-	-	450	-	-	

*upon request

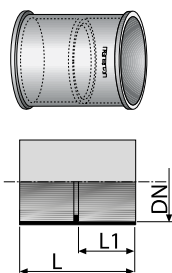

Coupler with central stop F/F Manchon avec butée F/F - Manguito de unión con tope H/H

DN (mm)	Reference			L (mm)	L1 (mm)	Note
32	063030M	100	8.100	49	23	
40	063040M	50	4.050	57	27	
50	063050M	40	2.080	67	32	
63	063060M	20	1.040	81	39	
75	063070M	20	1.040	92	44,5	
80	063080M	20	1.040	97	47	
100	063100M	60	480	116	57	
110	063110M	12	288	125	61	
125	063120M	35	280	138	67,5	
160	0631602	18	144	172	84	
200	0632002	8	64	217	106	
250	0632502	1	36	252	123	
315	0633002	1	20	296	145	

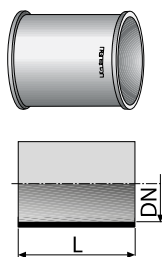

Slip coupler Manchon coulissant - Manguito deslizante

DN (mm)	Reference			L (mm)	Note
32	061030M*	100	8.100	49	
40	061040M*	50	4.050	57	
50	061050M*	40	2.080	67	
100	061100M	16	384	116	
125	061120M	35	280	138	
160	0611602	18	144	172	
200	0612002	8	64	217	
250	0612502	1	36	252	
315	0613002	1	20	296	

*upon request

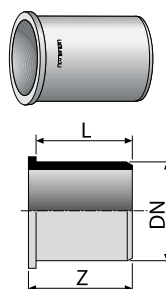

Coupler with collar Douille d'évacuation - Acoplamiento con valona

Ø ghiera	DN (mm)	Reference			L (mm)	Z (mm)	Note
1" 1/4	32	062320M*	100	8.100	39,5	42	
1" 1/2	40	062400M	100	8.100	39,5	42	

*upon request

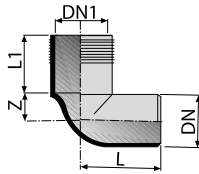
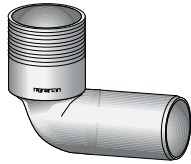

Long WC bend

Coude WC haut - Manguito inodoro acodado largo

DN (mm)	DN1 (mm)	Reference			L (mm)	L1 (mm)	Z (mm)	Note
100	116	02510A2	25	200	127	113	48	

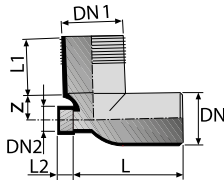
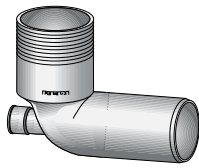

Long WC bend with frontal inlet

Coude WC haut avec 1 entrée frontale

Manguito inodoro acodado largo 1 toma frontal

DN (mm)	DN1 (mm)	DN2 (mm)	Reference			L (mm)	L1 (mm)	L2 (mm)	Z (mm)	Note
100	116	40	02514A2*	25	200	175	225	27	48	

*upon request

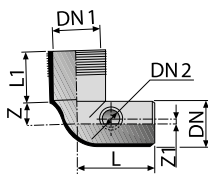
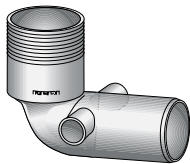

Long WC bend with 2 side-inlets

Coude WC haut avec 2 entrées laterales

Manguito inodoro acodado largo 2 tomas laterales

DN (mm)	DN1 (mm)	DN2 (mm)	Reference			L (mm)	L1 (mm)	Z (mm)	Z1 (mm)	Note
100	116	40	02544A2*	15	120	175	113	48	10	
100	116	50	02555A2*	15	120	175	113	48	10	

*upon request

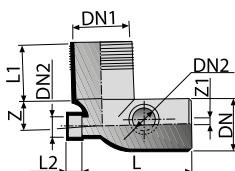
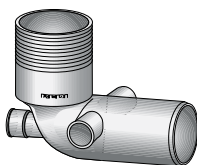

Long WC bend with 3 side-inlets

Coude WC haut avec 3 entrées laterales

Manguito inodoro acodado largo 3 tomas auxiliares

DN (mm)	DN1 (mm)	DN2 (mm)	Reference			L (mm)	L1 (mm)	L2 (mm)	Z (mm)	Z1 (mm)
100	116	40	02564A2*	15	120	225	113	27	48	10

*upon request



WC snap cap

Bague de sertissage WC - Anillo de inserción inodoro

DN (mm)	DN1 (mm)	Reference			L (mm)	Colour
126	116,5	0201302	100	2.000	25	Grey
126	116,5	0201303	100	2.000	25	White

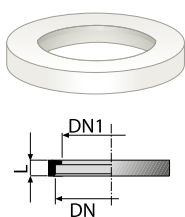

Gasket for WC bends and connectors

Joint pour coudes et manchons WC avec anneau de blocage

Junta para manguitos inodoro con anillo de bloqueo

DN (mm)	Reference			L (mm)	Colour
70	7810003	1	800	21,5	White

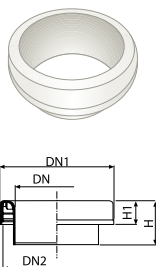

Gasket WC

Joint WC - Junta inodoro

DN (mm)	DN1 (mm)	DN2 (mm)	Reference			H (mm)	H1 (mm)	Colour
94	130	120,5	0011003	25	2.000	50,5	27	White

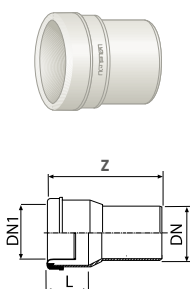

Straight WC connector

Sortie WC droite - Manguito inodoro corto

DN (mm)	DN1 (mm)	Ref.			L (mm)	Z (mm)	Colour	Note
100	95÷105	16010C3*	40	320	80	162	White	
110	95÷105	16031C3*	40	320	80	162	White	
100	-	06010C3*	1	310	80	162	White	without gasket/sans joint/sin junta
110	-	06031C3*	1	310	80	162	White	without gasket/sans joint/sin junta

*upon request

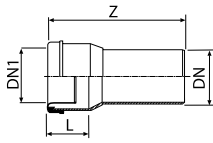
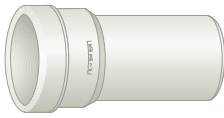

Long straight WC connector

Sortie WC droite longue - Manguito inodoro largo

DN (mm)	DN1 (mm)	Ref.			Z (mm)	Colour	Note
100	95÷105	16010L3	25	200	250	White	
110	95÷105	16031L3*	20	160	250	White	
100	-	06010L3	1	230	250	White	without gasket/sans joint/sin junta
110	-	06031L3*	1	-	250	White	without gasket/sans joint/sin junta

*upon request

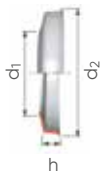

Rosette for WC connector

Rosace pour sortie WC - Plafón para salida inodoro

d1 (mm)	d2 (mm)	Reference			L (mm)	Colour
100	137	0481003*	20	1.620	30	White
110	162	0481103	50	1.200	35	White

*upon request

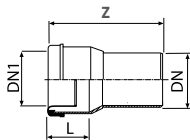

Extension for WC bend

Manchette pour coude WC - Extensión para manguito inodoro

DN (mm)	DN1 (mm)	Reference			L (mm)	Z (mm)	Colour	Note
116	95÷105	1601103	10	240	50	135	White	
116	-	0601103*	10	240	50	135	White	without gasket/sans joint/sin junta

*upon request

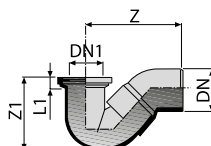
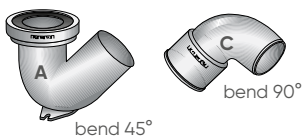
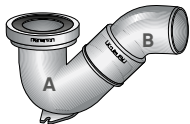

Low backed gully with bend

Siphon pour siège à la turque - Sifón placa turca

DN (mm)	DN1 (mm)	Reference			L (mm)	Z (mm)	Z (mm)	Type
110	95÷135	1771402	15	120	33	280	214	A
100	95÷135	17710A2*	10	80	33	280	214	A + B
110	95÷135	17714A2*	10	80	33	200	214	A + B
110	95÷135	17714C2*	10	80	33	310	214	A + C

*upon request

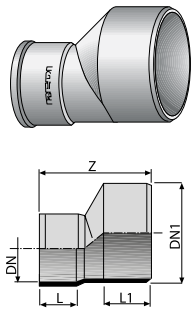
**Invert reducer M/F****Réduction excentrée M/F - Ampliación excéntrica M/H**

DN (mm)	DN1 (mm)	Reference			L (mm)	L1 (mm)	Z (mm)	Note
32	50	091050M	150	3.600	23	32	75	
40	50	091250M	110	2.640	27	32	71	
40	63	0900602	70	1.680	36	50	116	
40	100	090480M*	30	720	36	58	142	
50	63	090260M	50	1.200	40	50	114	
50	75	051070M	50	1.200	40	48	115	
50	80	090080M	40	960	40	53	128	
50	100	090100M	30	720	40	62	148	
50	110	051110M	50	400	40	70	173	
63	80	0902802	50	800	43	53	122	
63	100	0903002*	30	720	43	61	142	
75	110	0513102	25	450	-	-	-	
80	100	090500M	20	480	46	61	135	
100	125	090120M	45	360	57	61	134	
100	140	E511002	30	240	-	-	-	
100	160	E511302	30	240	-	-	-	
100	200	E511502	15	120	-	-	-	
110	125	051320M	35	280	56	69	148	
110	160	0511602	30	240	56	82	180	
125	160	0513602	30	240	62	82	180	
125	200	0512002	15	120	62	100	221	
125	250	0534202	10	80	62	90	159	
140	160	0515602	30	240	60	81	166	
140	200	E512202*	4	96	-	-	-	
160	200	0514002	15	120	74	100	211	
160	250	0514602	6	48	74	90	172	
160	315	0534802	5	40	74	93	174	
200	250	0512502	5	60	86	134	265	
200	315	0513302	4	32	86	145	318	
250	315	0513002	1	32	103	144	307	
315	400	0519202	1	18	118	156	363	

*upon request

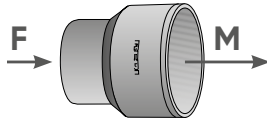

Conic reducer F/M

Réduction conique F/M - Reducción doble H/M

DN (F) / DN (M) (mm)	Reference			Note
63/75	0530702	50	-	
63/110	0503102	25	500	
100/110	0533102	25	500	

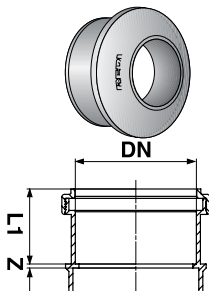

Inside reducer M/M

Réduction incorporée M/M - Tapón de reducción H/H

DN (mm)	DN1 (mm)	Reference			L (mm)	L1 (mm)	Z (mm)	Note
32	40	054040M	150	7.800	22	26	33	
32	50	054050M	80	4.160	22	31	42	
40	50	054250M	80	4.160	26	31	39	

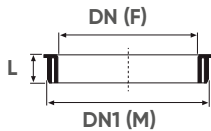

Concentric reducer M/F

Réduction concentrique M/F - Reducción concéntrica M/H

DN (mm)	DN1 (mm)	Reference			L (mm)	Note
110	125	0209202	35	1.820	22	

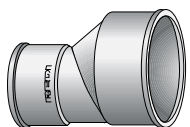
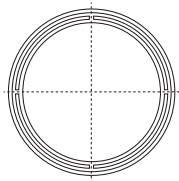

Invert reducer double socket F/F

Réduction excentrée F/F - Ampliación excéntrica H/H

DN (mm)	DN1 (mm)	Reference			L (mm)	L1 (mm)	Z (mm)	Note
32	50	092050M	150	3.600	23	32	75	
40	50	092250M*	130	3.120	27	32	71	

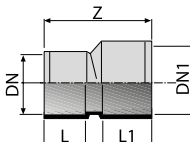

*upon request

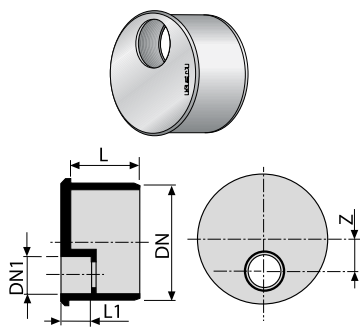

Reducing plug M/F

Tampon de reducción M/F - Tapón reductor M/H

DN (mm)	DN1 (mm)	Reference			L (mm)	L1 (mm)	Z (mm)	Note
63	32	054070M	40	3.240	-	-	-	
63	40	054060M	40	3.240	38	27	3	
63	50	054090M*	40	3.240				
80	40	054080M*	25	2.025	47	27	11,5	
80	50	054850M	25	2.025	-	-	-	
100	32	R6000NI	10	1.920	-	-	-	
100	40	054100M	20	1.040	56	26	28	
100	50	054200M	20	1.040	56	31	23	
100	63	054300M	20	1.040	56	38	16	
100	80	054400M	20	1.040	56	47	8	
110	40	054910M	35	840	60	27	32	
110	50	054920M	35	840	60	32	27	
110	63	054970M	35	840	60	38	20	
110	75	054930M	35	840	60	44,5	14,5	
110	80	054940M	35	840	60	47	12	
110	100	054990M	35	840	60	57	0	
125	40	054120M*	30	720	-	-	-	
125	50	054130M*	30	720	-	-	-	
125	80	X4440NI	25	-	-	-	-	
125	100	054150M	10	520	-	-	-	
125	110	054160M	10	520	-	-	-	

*upon request

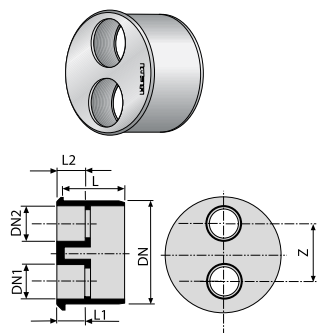

Reducing plug M/F

Tampon de reducción M/F - Tapón reductor doble M/H

DN (mm)	DN1 (mm)	DN2 (mm)	Reference			L (mm)	L1 (mm)	L2 (mm)	Z (mm)	Note
100	40	32	054600M*	20	1.040	56	26	22	60	
100	40	40	054700M	20	1.040	56	26	26	56	
100	50	40	054800M	20	1.040	56	31	26	51	
110	40	40	054950M	35	840	60	27	27	95	
110	50	40	054960M*	35	840	60	32	27	90	

*upon request

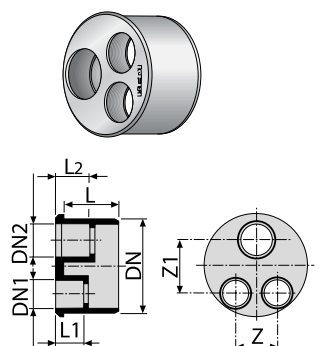

Reducing plug M/F

Tampon de reducción M/F - Tapón reductor triple M/H

DN (mm)	DN1 (mm)	DN2 (mm)	Reference			L (mm)	L1 (mm)	L2 (mm)	Z (mm)	Z1 (mm)	Note
110	40	40	054980M	35	840	60	27	27	56	48	

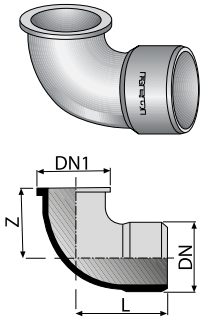
**Bend with collar 87°30'****Coude à collet 87°30' - Codo con valona 87°30'**

DN (mm)	DN1 (mm)	Reference			L (mm)	Z (mm)	Note
1" 1/4 32	38	026030M*	100	5.200	43	33	
1" 1/2 40	44,5	026040M	150	3.600	55	42	

*upon request

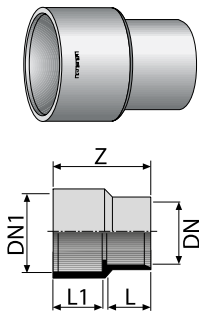
**Coupler with collar F/F****Manchon à collet F/F - Manguito con collar H/H**

DN (mm)	DN1 (mm)	Reference			L (mm)	L1 (mm)	Z (mm)	Note
32	40	060320M*	50	4.050	22,5	26,5	51	

*upon request

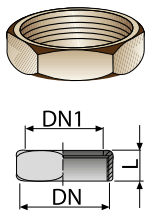
**Brass nut****Écrou laiton - Tuerca latón**

DN (mm)	DN1 (mm)	Reference			L (mm)	Note
1" 1/4 35	35	C661400	5	16.200	15	
1" 1/2 40	40	C661200	5	12.150	15	

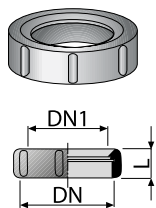
**PP nut****Écrou en PP - Tuerca en PP**

DN (mm)	DN1 (mm)	Reference			L (mm)	Note
1" 1/2 42	42	B661202	1	10.400	20	

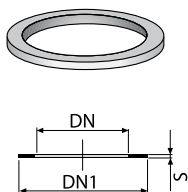

Gasket
Joint plat - Junta plana

DN (mm)	DN1 (mm)	Reference			S (mm)	Note
1" 1/4	39	B821400	1	-	2,5	
1" 1/2	44	B821200	1	-	2,5	

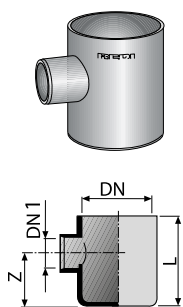

Floor gully
Collecteur - Colector 1 salida

DN (mm)	DN1 (mm)	Reference			L (mm)	Z (mm)	Note
100	40*	0961002*	20	480	120	74	

* Outlet Ø 40 Female / Sortie Ø 40 Femelle

*upon request

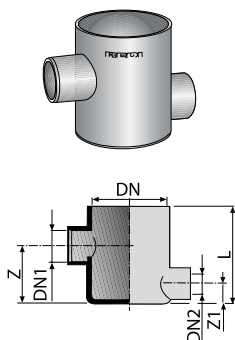

Floor gully
Collecteur - Colector 2 salidas

DN (mm)	DN1 (mm)	DN2 (mm)	Reference			L (mm)	Z (mm)	Z1 (mm)	Note
100	40/50*	40	0971022*	20	480	120	74	25	

* Outlet Ø 40 Female - Outlet Ø 50 Male

* Sortie Ø 40 Femelle - Sortie Ø 50 Male

*upon request

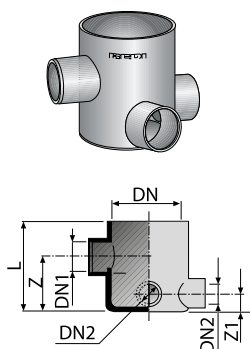

Floor gully
Collecteur - Colector 3 salidas

DN (mm)	DN1 (mm)	DN2 (mm)	Reference			L (mm)	Z (mm)	Z1 (mm)	Note
100	40/50*	40	0971042*	40	320	120	74	25	
100	50	40	0941042*	40	320	120	80	25	

* Outlet Ø 40 Female - Outlet Ø 50 Male

* Sortie Ø 40 Femelle - Sortie Ø 50 Male

*upon request

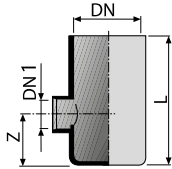
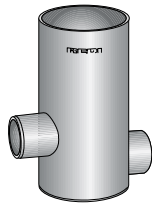

High floor gully - 2 outlets

Collecteur haut - 2 sorties - Colector alto 2 salidas

DN (mm)	DN1 (mm)	DN2 (mm)	Reference			L (mm)	Z (mm)	Z1 (mm)	Note
100	40/50*	40	0951022*	10	240	200	74	25	

* Outlet Ø 40 Female - Outlet Ø 50 Male

* Sortie Ø 40 Femelle - Sortie Ø 50 Male

*upon request

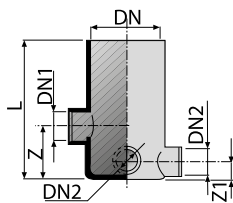
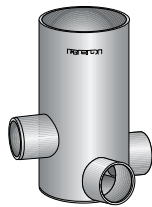

High floor gully - 3 outlets

Collecteur haut - 3 sorties - Colector alto 3 salidas

DN (mm)	DN1 (mm)	DN2 (mm)	Reference			L (mm)	Z (mm)	Z1 (mm)	Note
100	40/50**	40	0981042*	22	176	200	74	25	
100	50	40	0951042*	25	200	200	80	25	

** Outlet Ø 40 Female - Outlet Ø 50 Male / Sortie Ø 40 Femelle - Sortie Ø 50 Male

*upon request

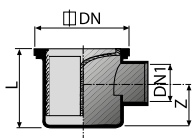

PVC trapped floor drain (horizontal outlet)

Siphon de cour PVC (sortie horizontale)

Sumidero sifónico, salida horizontal hembra de PVC

DN (mm)	DN1 (mm)	Reference			L (mm)	Z (mm)	Note
100	40 external /32 internal	0210304	16	832	82	45	
100	40 internal	0210404	16	832	82	45	



Floor gully
Collecteur grand débit - Colector

DN (mm)	DN1 (mm)	DN2 (mm)	DN3 (mm)	Reference			Note
160	110	75	110	0961602	10	80	
F/Sk	M/Sp	F/Sk	F/SK				

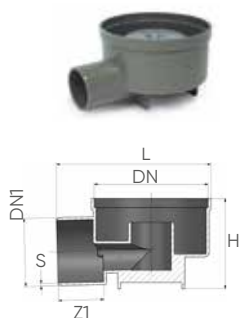

Trapped balcony outlet
Siphonnette de balcon - Terminal bote sifónico para terraza

DN (mm)	DN1 (mm)	Reference			L (mm)	H (mm)	Z1 (mm)	S (mm)	Note
125	50	19935F2	15	360	169	88	40	3	
125	75	19937F2	15	360	169	100	50	3	



Floor trap with Multi-inlets
Siphon parquet - Terminal bote sifónico entradas múltiples

Ø (mm)	DN (mm)	DN1 (mm)	DN2 (mm)	Reference			L (mm)	H (mm)	H1 (mm)	H2 (mm)	Version
150	125	75*	50**	1961202	20	160	237,5	137,5	92	50	High / Haute / Alto
150	125	75*	50**	19613B2	24	192	237,5	107,5	82	35	Low / Baisse / Corto

Connections: * 1 spigot outlet DN 75 mm. ** 3 female blank inlets DN 50 mm.
 Connections: * 1 sortie male DN 75 mm . ** 3 entres femelle DN 50 mm.

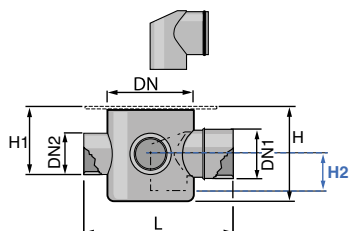

Water seal 50 mm in compliance with UNI EN1253



PVC insulating membrane

Membrane d'étanchéité - Lámina de PVC, impermeabilizante

DN (mm)	Reference			Note
1500 x 1500 x 0,8 mm	J022087	1	36	1 single sheet

Material: PVC plasticized - Colour: Grey - Use: waterproofing sheet

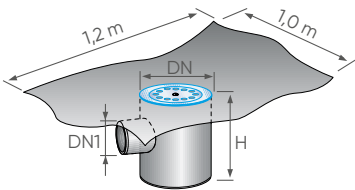

Floor gully with PVC membrane

Collecteur avec membrane d'étanchéité

Colector con lámina impermeabilizante

DN (mm)	DN1 (mm)	Reference			H (mm)	Note
100	40	1960402*	1	64	120	

*upon request

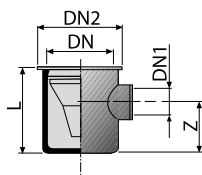

Floor trap with inox grid and funnel

Siphonette avec grille inox et entonnoir

Sifón con rejilla de acero inox y embudo

DN (mm)	DN1 (mm)	DN2 (mm)	Reference			L (mm)	Z (mm)	Note
100	40/50*	125	1961002	15	360	121	74	

* Male outlet / Sortie male

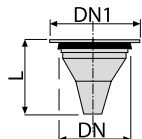

Inox grid with funnel

Grille inox avec entonnoir - Rejilla de acero inox y embudo

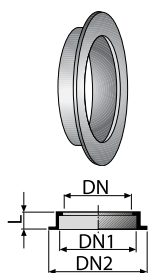

DN (mm)	DN1 (mm)	Reference			L (mm)	Note
100	125	1993302	1	720	106	



Locking ring for PVC membrane

Anneau de blocage de la membrane d'étanchéité

Anillo de bloqueo de la junta de estanqueidad

DN (mm)	DN1 (mm)	DN2 (mm)	Reference			L (mm)	Note
100	107	145	0201002*	20	2.000	20	



*upon request



Protection cap for floor gully

Plaque de protection pour collecteur

Tapón de protección bote sifónico

DN (mm)	Reference			Note
100	T651000	20	2.000	Made of plastics

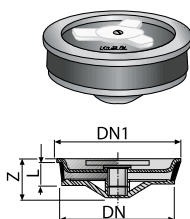

Plug for floor gully

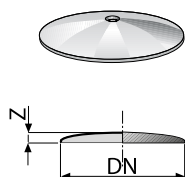

Bouchon pour collecteur - Tapa expansión para colector

DN (mm)	DN1 (mm)	Reference			L (mm)	Z (mm)	Note
100	106	0661002	20	1.620	20	35	



Stainless steel plate

Plaque de protection inox - Tapa de acero inoxidable

DN (mm)	Reference			Z (mm)	Note
135	PIAOXNI	20	26400	5	

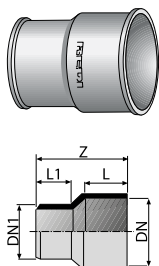

Technical coupling M/F

Manchon technique M/F - Manguito técnico M/H

DN (mm)	DN1 (mm)	Reference			L (mm)	L1 (mm)	Z (mm)	Note
40	50	0930302*	50	2.600	22,5	31	55,5	F/F
40	32	0930402	50	4.050	26,5	22,5	57,5	M/F
50	40	0930502	50	2.600	31,5	26,5	67,5	M/F

*upon request

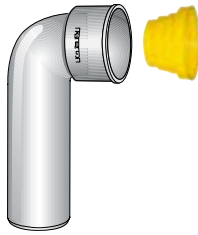

Technical bend long version M/F

Coûde technique long M/F - Codo técnico M/H

DN (mm)	DN1 (mm)	Reference			L (mm)	L1 (mm)	Z (mm)	Note
40	50	074540M*	5	1.200	33	150	17	

With protection plug / Avec bouchon de protection / Con tapa protectora

*upon request

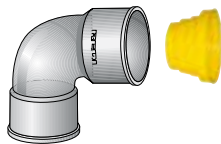
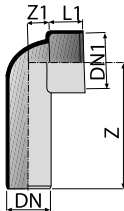

Technical bend F/F

Coûde technique F/F - Codo técnico H/H

DN (mm)	DN1 (mm)	Reference			L (mm)	L1 (mm)	Z (mm)	Z1 (mm)	Note
32	40	024230M	130	3.120	23	28	29	14	
40	50	024240M	70	1.680	26	33	-	17	

With protection plug / Avec bouchon de protection / Con tapa protectora

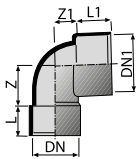

Technical bend M/F

Coûde technique M/F - Codo técnico M/H

DN (mm)	DN1 (mm)	Reference			L (mm)	L1 (mm)	Z (mm)	Z1 (mm)	Note
32	40	074230M*	80	1.920	23	28	29	14	
32	50	074530M*	80	1.920	26	33	36	17	
40	50	074240M*	80	1.920	-	-	-	-	

With protection plug / Avec bouchon de protection / Con tapa protectora

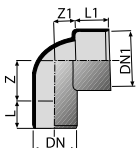

*upon request

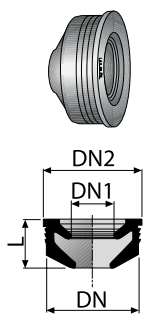



Gasket

Joint - Junta de goma

DN (mm)	DN1 (mm)	DN2 (mm)	Reference			L (mm)	Note
32	1"	37	6820300	50	24.000	13	
40	1"	46,5	6820400	50	1.000	18	
40	1" 1/4	46,5	6820401	50	12.000	18	
50	1"	55	6820502	50	6.000	19	
50	1" 1/4	56	6820500	50	6.000	19	
50	1" 1/2	55	6820501	50	6.000	19	

1" = 26 mm. 1"1/4 = 32 mm. 1"1/2 = 40 mm.

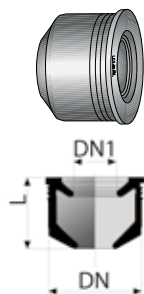

Long Gasket

Joint long - Junta de goma larga

DN (mm)	DN1 (mm)	Reference			L (mm)	Note
50	1"	68255LU	50	6.000	33	
50	1" 1/4	68265LU	50	6.000	33	
50	1" 1/2	68260LU	50	6.000	33	

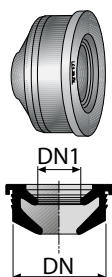

1" = 26 mm. 1"1/4 = 32 mm. 1"1/2 = 40 mm.



Technical gasket with nut (for bends and couplers)

Joint technique avec écrou (pour coudes et manchons)

Junta técnica con tuerca (para codos y manguitos)

DN (mm)	DN1 (mm)	Reference			Note
37	1"	6823200*	1	4.200	
45	1" 1/4	6824404*	50	14.400	

1" = 26 mm. 1"1/4 = 32 mm. 1"1/2 = 40 mm.

*upon request

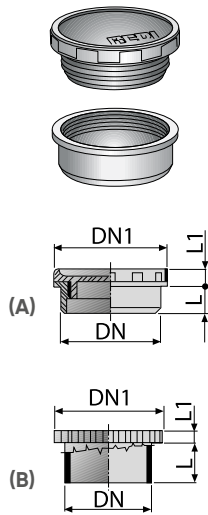

Access plug M

Tampon de visite M - Tapón de inspección M

DN (mm)	DN1 (mm)	Reference			L (mm)	L1 (mm)	Note
32	39	065320M	50	20.250	15	8,5	(A) With gasket / Avec joint / Con junta
40	47	065400M	50	12.150	15	8,5	(A) With gasket / Avec joint / Con junta
50	57	065500M	25	8.100	15	8,5	(A) With gasket / Avec joint / Con junta
63	78	065060M	90	2.160	38	17	(B)
75	97	065070M	20	1.040	44	17	(B)
80	97	065080M	50	1.200	47	17	(B)
90	-	0650902	30	720	52	-	(B)
100	116	065100M	30	960	56	20	(B)
110	-	0651102	70	560	62	22	(B)
125	-	0651202	50	400	60	20	(B)
160	-	1651602	30	240	60	20	(B)
200	-	1652002	15	120	80	22	(B)
250	-	1652502	10	100	90	17	(B)
315	-	1653002	6	48	93	21	(B)

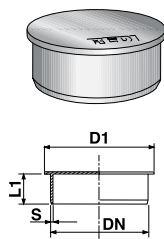

Socket plug M

Bouchon de fermeture M - Tapón ciego M

DN (mm)	DN1 (mm)	Reference			L (mm)	S (mm)	Note
40	45	0660402	50	12.000	18	2,5	
50	55	0660502	50	8.400	20	2,5	
100	104	0669902	45	1.080	15	-	
110	126	0661102	150	1.200	38	3,2	
125	142	0661202	100	800	42	3,2	
160	180	0661602	55	440	49	4,0	
200	223	0662002	25	200	59	4,9	
250	282	0662502	1	114	90	6,2	
315	350	0663002	1	67	93	7,7	
400	440	06640M2	1	50	95	9,8	

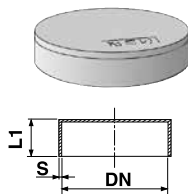

Female cap F

Bouchon femelle F - Tapón hembra H

DN (mm)	Reference			L1 (mm)	S (mm)	Note
110	06613F2	30	1.560	32	2,0	
125	06615F2	20	1.040	32	2,5	
160	06617F2	30	720	35	2,7	
200	06621F2	60	480	35	2,9	
250	06628F2	30	240	40	3,5	
315	06634F2	15	120	52	4,0	
400	06640F2	1	50	52	4,0	

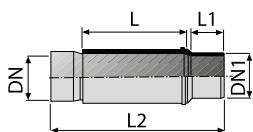

Repairing coupler (orange colour)
Manchon de réparation (couleur orange)
Manguito de reparación (color naranja)

DN (mm)	DN1 (mm)	Reference Orange Ral 2003			L (mm)	L1 (mm)	L2 (mm)	Note
50	-	1790509	10	-	-	-	-	
63	-	1790609	5	-	150	50	-	
80	-	1790809	5	-	168	56	-	
100	94	1791009	5	150	240	76	324	
125	118	1791209	5	100	240	76	324	

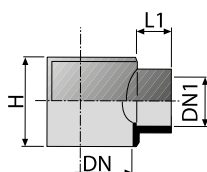

Clip
Selle - Injerto clip

DN (mm)	DN1 (mm)	Reference			H (mm)	L1 (mm)	Note
100 - 110 - 115	32	043050M	20	1.040	80	25	
100 - 110 - 115	40	043100M	20	1.040	80	27	
100 - 110 - 115	50	043300M	20	1.040	80	32	

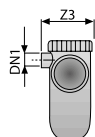
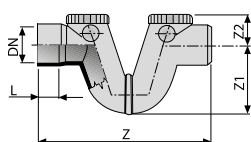

Siphon O-O (with blank outlets for ventilation Ø40)
Siphon O-O (avec piquage pour ventilation Ø40)
Sifón en línea (con conexión para ventilación Ø40)

DN (mm)	DN1 (mm)	Reference Orange Ral 2003			L (mm)	Z (mm)	Z1 (mm)	Z2 (mm)	Z3 (mm)	Note
140	40	1751409	1	24	-	-	-	-	-	
160	50	1751609	1	18	-	-	-	-	-	
200	50	1752009	1	9	-	-	-	-	-	

RAL 2003: orange colour / couleur orange / color naranja

How to use the solvent cement welding socket couplers



Apply the solvent cement lengthwise on the previously cleaned pipe end.

Apply the solvent cement inside the coupler's spigot end

Fit the socket coupler without turning it until it stops against pipe end.

Cut the pipe into the required length. If necessary, deburr pipe end with a chamferer.

How to use the push-fit socket couplers

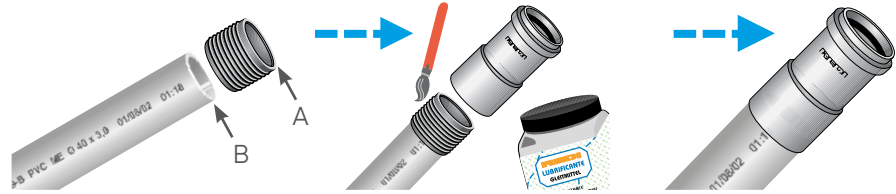

Fit the corrugated gasket onto the pipe end as shown in the picture (the sealing edge A to be in contact with pipe's front section B).

Apply a thin layer of lubricant onto the corrugated gasket.

Fit the socket coupler without turning it until it stops against pipe end.

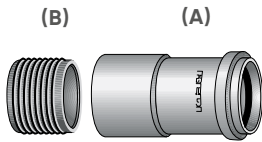

Socketer coupler - push-fit version F/F

Manchon avec joint F/F

Manguito de conexión push-fit con junta H/H

DN (mm)	Reference			Note
(A) 40	063228M	50	2.600	
(A) 50	063238M	35	1.820	

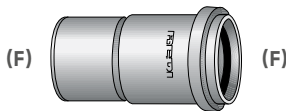

Socketer coupler - solvent welding version F/F

Manchon à coller F/F

Manguito de conexión push-fit encolar H/H

DN (mm)	Reference			Note
40	063338M	10	2.600	
50	063348M	40	2.080	

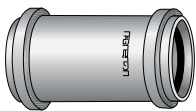

Slip coupler with 2 gaskets F

Manchon coulissant avec 2 joints F

Manguito deslizante H, con junta labiada H

DN (mm)	Reference			Note
40	061445M	10	1.920	

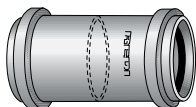

Coupler with central stop with 2 gaskets F/F

Manchon avec butée avec 2 joints F/F

Manguito con tope H/H, con junta labiada

DN (mm)	Reference			Note
40	063445M	40	2.080	
50	063455M	50	1.200	



PVC



PE

CUBO REDI
Syphon for washing-machine

Siphon machine à laver

Sifón sencillo para empotrar, toma lavadora

DN (mm)	Reference			Note
40	1999903	8	416	for PVC pipes
40/50	199PE03	6	312	for PE pipes

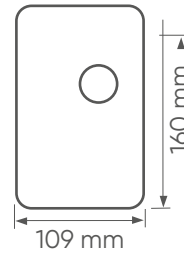
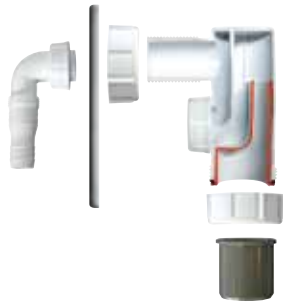

CUBO REDI
NEW Cover plate in stainless steel 160x109 mm



Inspection Syphon for washing-machine

Siphon machine à laver

Sifón sencillo para empotrar, toma lavadora



DN (mm)	Reference			Note
1" 1/2-40	19999S3	1	780	for PVC pipes

Packed in plastic bag



PE Syphon for washing-machine

Siphon machine à laver - Sifón máquina lavadora

DN (mm)	Reference			Note
40/50	C13PEAI	15	-	for PE pipes



Adaptor with Air Admittance Valve



Sortie avec anti-vide - Válvula aireación, toma lavadora

DN (mm)	Reference			Note
40	C130403	1	1.280	



Solvent cement THF free



Colle sans THF - Adhesivo sin THF

Pack. type	Content (ml)	Reference			Note
Tube	125	COLLA12	30	1920	
Jar	250	COLLA25	24	1296	With brush / Avec pinceau
Jar	500	COLLA50	16	768	With brush / Avec pinceau
Jar	1.000	COLLA00	8	432	With brush / Avec pinceau



Cleaner

Détergent - Limpiador

Pack. type	Content (ml)	Reference			Note
Can	1 litre	6721100	8	384	

PVC-U Soil & Waste System

REDI

1.2 PVC-U SOIL & WASTE



EN 1329 Push-Fit PVC-U Fittings



PVC-U

Soil & Waste System

REDI PVC-U Push-Fit fittings are compliant to the EN1329 standard.

The products standard compliance guarantees the respect of the required dimensional tolerances, the designs criteria and the performances for building water drainage applications.

General characteristics of PVC

- Name: Polyvinyl Chloride
- Color: RAL 8023 - Red
- Operation Temperature Range:
70 °C is the MAX temperature of waste water in permanent conditions.
For discontinuous drainage applications as common household appliances discharge, instant peak of 95 °C are allowed

Certificates: EN1329

Plastics piping systems for soil and waste discharge, low and high temperature, within the building structure - Unplasticized Polyvinyl Chloride



The certificates shown on this catalogue may be subject to revisions.
Updated certificates for each product are available on website www.aliaxis.it

Connection

Sockets are fitted with preassembled and prelubricated lip seal gasket.

Gasket section



Flow direction in reference to the position of the gasket.

Gasket certificates

The certificates printed on these pages are constantly updated. The updated certificates are available on our website www.aliaxis.it

MPS NRW

Standard nr. 220000032 04-02-1b
DIN 4060

KIWA KOMO

Standard nr. K4195/06
Type rubbe SBR ss-p-60-00

BSI

Standard nr. KM 51718
BS EN 681-1

DNV Det Norske Veritas

Standard n. 112.929.01-01E; SS-EN 681-1
Type test report: SP report No. 98K12514 A-C, 98K 12558, 99K12583, 99K12604, F020847C, F101033

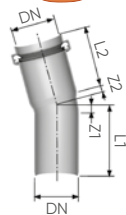

Bend S/S 15°
Coude 15° M/F - Codo 15° M/H

DN (mm)	Reference RAL 8023 Red EN1329			Z1 (mm)	Z2 (mm)	L1 (mm)	L2 (mm)	Note
40	0100411	25	2.025	3	27	48	41	

Lip Ring

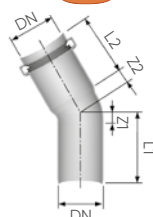

Bend S/S 30°
Coude 30° M/F - Codo 30° M/H

DN (mm)	Reference RAL 8023 Red EN1329			Z1 (mm)	Z2 (mm)	L1 (mm)	L2 (mm)	Note
40	0110411	25	2.025	5	19.5	49	41	
100	0781011	12	288	12	20	68	56	

Lip Ring

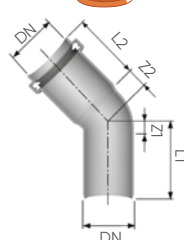

Bend S/S 45°
Coude 45° M/F - Codo 45° M/H

DN (mm)	Reference RAL 8023 Red EN1329			Z1 (mm)	Z2 (mm)	L1 (mm)	L2 (mm)	Note
40	0700411	100	2.400	8	22	48	36	
50	0700511	60	1.440	10	24	52	40	
63	0700611	40	960	-	-	-	-	
75	0730711	25	600	16	25	52	45	
82	0708211	25	600	-	-	-	-	
100	0701011	40	320	20	35	62	53	

Lip Ring

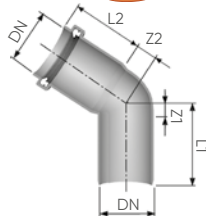

Bend S/S 67°30'
Coude 67°30' M/F - Codo 67°30 M/H

DN (mm)	Reference RAL 8023 Red EN1329			Z1 (mm)	Z2 (mm)	L1 (mm)	L2 (mm)	Note
100	0721011	30	240	33	53	75	57	

Lip Ring

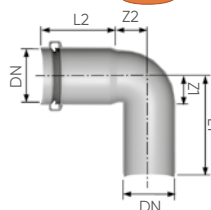

Bend S/S 87°30'
Coude 87°30' M/F - Codo 87°30 M/H

DN (mm)	Reference RAL 8023 Red EN1329			Z1 (mm)	Z2 (mm)	L1 (mm)	L2 (mm)	Note
40	0710411	100	2.400	-	-	-	-	
50	0710511	50	1.200	-	-	-	-	
63	0710611	30	720	-	-	-	-	
75	0740711	20	480	-	-	-	-	
100	0711011	30	240	-	-	-	-	

Lip Ring

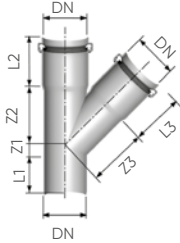
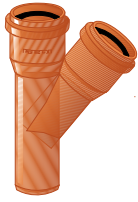

Branch 45° D/S

Culotte 45° M/F - Derivación 45° M/H

DN (mm)	Reference RAL 8023 Red EN1329			Z1 (mm)	Z2 (mm)	Z3 (mm)	L1 (mm)	L2 (mm)	L3 (mm)
40	0800411	50	1.200	9	52	52	49	45	45
50	0800511	25	600	14	70	70	48	40	40
63	0880611	15	360	-	-	-	-	-	-
75	0880711	10	240	15	93	93	51	45	45
100	0881011	15	120	25	131	131	60	53	53

Lip Ring

Unequal branch 45° D/S

Culotte et embranchement 45° M/F Derivación reducida 45° M/H



DN (mm)	Reference RAL 8023 Red EN1329			Note
100/40	0831011	10	240	
100/50	0833011	10	240	
110/63	D312611	5	-	
110/75	O315111	20	160	
110/100	D312811*	5	-	
125/75	D312711	10	100	

*upon request Lip Ring

Unequal branch 45° D/S

Embranchement double 45° M/F Derivación doble reducida 45° M/H



DN-DN1 (mm)	Reference RAL 8023 Red EN1329			Note
100-40-40	0415011*	8	192	
100-50-50	0414911*	7	168	

*upon request Lip Ring

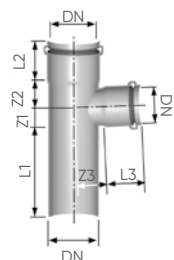
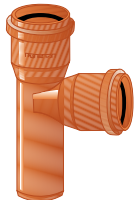

Branch 87° D/S

Culotte 87° M/F - Derivación 87° M/H

DN (mm)	Reference RAL 8023 Red EN1329			Z1 (mm)	Z2 (mm)	Z3 (mm)	L1 (mm)	L2 (mm)	L3 (mm)
82	0818211*	30	300	-	-	-	-	-	-
100	0811011	20	160	55	64	64	55	53	53

*upon request Lip Ring

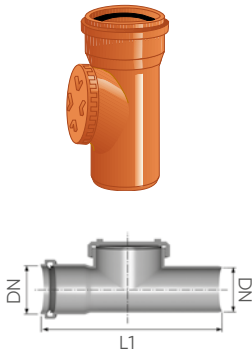

Access pipe
Tè de visite - Te con boca de registro

DN (mm)	Reference RAL 8023 Red EN1329			L1 (mm)	Note
100	1821011*	20	160	227	

*upon request

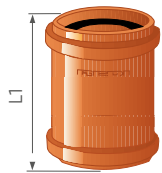

Repair/Slip coupler F/F
Manchon coulissant F/F - Manguito deslizante H/H

DN (mm)	Reference RAL 8023 Red EN1329			L1 (mm)	Note
63	D610611	10	-	-	
75	0610751	10	810	92	

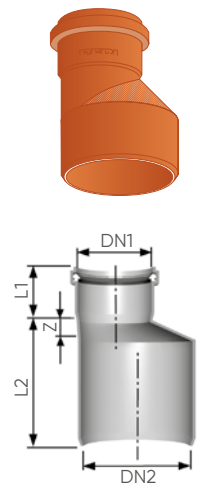

Invert reducer M/F
Réduction excentrée M/F - Ampliación excéntrica M/H

DN1-DN2 (mm)	Reference RAL 8023 Red EN1329			Z (mm)	L1 (mm)	L2 (mm)	Note
40/50	0900511	80	1.920	22	42	48	
40/63	0900611	60	1.440	-	-	-	
40/100	0904811	30	600	48	42	58	
50/63	0902611	50	1.200	-	-	-	
50/75	0510711	40	960	30	45	48	
50/100	0901011	25	600	45	45	61	
50/110	0511111	50	400	51	45	70	
63/100	0903011	30	720	-	-	-	
75/100	0503311	25	500	31	50	61	
75/125	0907311	10	300	48	55	115	
100/125	0901211	10	240	16	57	61	



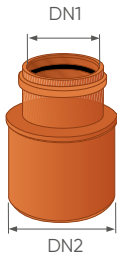

Invert reducer M/F

Réduction M/F - Ampliación excéntrica M/H

DN1-DN2 (mm)	Reference RAL 8023 Red EN1329			Note
63/75	0530711	40	960	
100/110	0533111	18	432	

Lip Ring



Invert reducer M/F

Réduction M/F - Ampliación M/H

DN (mm)	Reference RAL 8023 Red EN1329			Note
40	0635589	50	2.600	
50	0635689*	40	2.080	

*upon request Lip Ring



Invert reducer M/F

Réduction M/F - Ampliación M/H

DN1-DN2 F - M (mm)	Reference RAL 8023 Red EN1329			Note
125/100	0931211	15	360	
125/110	D931111	45	360	

Lip Ring

Lip ring

Joint à lèvres - Junta labiada



DN (mm)	Reference			Note
40	6830400	1	40.768	
50	6830500	1	29.568	
75	6830700	1	13.970	
82	6808200*	1	100.000	OR section round
100	6801000*	1	50.000	

*upon request

PP Soil & Waste System

ULTRAMAX

AMAX

1.3 PP SOIL & WASTE



EN 1451 Push-Fit PP Pipe and Fittings
Impact-Resistant
B1 Fire Reaction Class, Self-extinguishing



ULTRAMAX Pipe Range Completed by **AMAX** Fittings

ULTRAMAX completed with AMAX fittings range is the push-fit polypropylene complete soil and waste system for civil and industrial waste water drainage.

- ULTRAMAX features:**
- White internal layer
 - Impact-resistant
 - B1 Fire Reaction Class according to DIN4102, Self-extinguishing

Pipe and Fittings available starting from Ø32 up to Ø160. Both Single and Double Socket Pipes available from 0.15 m up to 3 m length.



Fitting marking



Pipe marking:



Impact resistance

ULTRAMAX Pipes are produced with a multilayer technology and without using any mineral material additives. The great elasticity of the pipe allows a strength compression resistance if impact-stressed, without breaks, cracks or functional consequences even at low temperatures. The impact resistance is directly tested along line, at regular intervals, for each production batch.



1) Compression test of an ULTRAMAX pipe by REDI. During the test the pipe is hit with a 5 kg heavy hammer



2) After the impact of the ULTRAMAX pipe by REDI, it returns to its original form without cracks or crushing

White Interior

ULTRAMAX presents a perfectly WHITE and uniform interior. This feature is particularly appreciated during video inspection.

The technology used allows an extremely regular raw material extrusion flow, which allows a perfect fusion among different layers.



Self-extinguishing material

ULTRAMAX is completely self-extinguishing and matches Class B1 characteristics according to the DIN 4102 standard.



ULTRAMAX and AMAX Polypropylene System

Pipes and fittings are both made of self extinguishing polypropylene homopolymer.

The raw material performances is certified according to DIN 4102 quality tests, which certify the conformity to the required fire reaction specifications. The System is classified as B1 Fire Reaction class ("hardly flammable building material").

The products performances are certified according to the **EN 1451** standard ("Plastics piping systems for soil and waste discharge (low and high temperature) within the building structure - Polypropylene").

Conditions for use	Fields of application
95 °C is the MAX temperature of waste water conveyed allowed.	for sanitary fittings
	for washing-machines, dishwashers and boilers also extended for waste water (large kitchens, laundry rooms, industrial appliances)
	for corrosive fluids in schools, laboratories and industrial factories. In this case, the chemical resistance at the operating temperature can be derived from the ISO/TR7471344.

The certificates printed on these pages are constantly updated. The updated certificates are available on our website www.aliaxis.it



SKZ Certificate for pipe



SKZ Certificate for fittings

PP - Chemical resistance

Product	Conc. %	Temp. 20 °C	Temp. 60 °C	Product	Conc. %	Temp. 20 °C	Temp. 60 °C
ACETIC ACID	60	S	L	HYDROGEN	100	S	S
ACETIC ACID MONOCHLORIDE	SOL.	S	L	HYDROGEN DIOXIDE	30	S	L
ACETIC ALDEHYDE	33	L	NS	HYDROGEN SULPHIDE	100	S	S
ACETIC ANHYDRIDE	100	L	NS	ISOCTANE	100	L	S
ACETONE	100	S	S	LACTIC ACID	10	S	L
ADIPIC ACID	-	-	-	LACTIC ACID	10~90	L	L
ALLYL ALCOHOL	96	S	S	LEAD TETRAETHYL	100	S	-
ALUMINUM CHLORIDE	SOL. SAT.	S	S	MAGNESIUM SULPHIDE	SOL. SAT.	S	S
ALUMINUM SULPHATE	SOL. SAT.	S	S	MALEIC ACID	SOL. SAT.	S	L
AMMONIA (GAS)	100	S	S	METHYL ALCOHOL	100	S	L
AMMONIA (LIQUID)	100	S	L	METHYL METHACRYLATE	100	NS	NS
AMMONIA (SOLUTION)	SOL. DIL.	S	L	METHYLENE CHLORIDE	100	NS	NS
AMMONIUM CHLORIDE	SOL. SAT.	S	S	MILK		S	S
AMMONIUM FLUORIDE	-	-	-	MINERAL OIL	100	L	L
AMMONIUM NITRATE	SOL. SAT.	S	S	N-HEPTANE	100	L	NS
AMMONIUM SULPHATE	SOL. SAT.	S	S	NICKEL SULPHIDE	SOL. SAT.	S	S
AMYL ACETATE	100	NS	NS	NICOTINIC ACID	CONC.	S	S
AMYL ALCOHOL	100	S	L	NITRIC ACID	<25	L	NS
ANILINE	100	S	L	NITRIC ACID	50	NS	NS
ANILINE	SOL. SAT.	S	L	OLEIC ACID	100	L	L
ANILINE HYDROCHLORIDE	SOL. SAT.	-	-	OLEUM	10% of SO ³	NS	NS
ANTIMONY CHLORIDE	90	S	S	OXALIC ACID	25	S	L
ARSENIC ACID	SOL. DIL.	S	-	OXALIC ACID	SOL. SAT.	L	L
BEER		S	S	OXYGEN	SOL. SAT.	L	L
BENZALDEHYDE	100	S	-	PETROL	80/20	NS	NS
BENZENE	100	NS	NS	PETROLEUM	100	L	NS
BENZOIC ACID	SOL. SAT.	S	L	PHENOL	SOL. SAT.	S	S
BORAX	SOL. SAT.	S	L	PHOSPHINE	100	S	L
BORIC ACID	SOL. DIL.	S	L	PHOSPHOR OXICHLORIDE	100	L	L
BROMINE (LIQUID)	100	NS	NS	PHOSPHORIC ACID	30	S	L
BROMINE ACID	10	S	-	POTASSIUM BICHROMATE	SOL. 20	S	S
BUTADIENE	100	S	S	POTASSIUM BROMIDE	SOL. SAT.	S	S
BUTANE	100	S	-	POTASSIUM CHLORIDE	SOL. SAT.	S	S
BUTYL ACETATE	100	NS	NS	POTASSIUM CHROMATE	40	S	S
BUTYL PHENOL	100	NS	NS	POTASSIUM CYANIDE	SOL.	S	S
BUTYLENE	100	S	L	POTASSIUM FERRICYANIDE	SOL. SAT.	S	S
BUTYRIC ACID	20	S	L	POTASSIUM FERROCYANIDE	SOL. SAT.	S	S
BUTYRIC ACID	98	NS	NS	POTASSIUM HYDROXIDE	SOL.	S	S
CALCIUM CHLORIDE	SOL. SAT.	S	S	POTASSIUM NITRATE	SOL. SAT.	S	L
CALCIUM NITRATE	50	S	S	POTASSIUM PERMANGANATE	20	S	S
CARBON DIOXIDE	100	S	S	POTASSIUM PERSULFATE	SOL. SAT.	S	L
CARBON SULPHIDE	100	S	-	PROPANE (GAS LIQUID)	100	S	-
CARBON TETRACHLORIDE	100	NS	NS	PROPIONIC ACID	50	S	S
CHLORINE (DRY GAS)	100	NS	NS	PYRIDINE	100	NS	NS
CHLORINE (LIQUID)	SOL. SAT.	NS	NS	SEA WATER		S	L
CHLOROSULPHONIC ACID	100	NS	NS	SILVER NITRATE	SOL. SAT.	S	L
CHROMIC ACID	-	-	-	SOAP	SOL.	S	S
CITRIC ACID	SOL. SAT.	S	S	SODIUM BISULPHITE	SOL. SAT.	S	S
COPPER CHLORIDE	SOL. SAT.	S	S	SODIUM CHLORATE	SOL. SAT.	S	S
COPPER FLUORIDE	2	S	S	SODIUM CHLORIDE	SOL. SAT.	S	S
CREOSOL	100	L	NS	SODIUM FERRICYANIDE	SOL. SAT.	S	S
CREOSOL ACID	SOL. SAT.	NS	NS	SODIUM HYDROXIDE	SOL.	S	S
CROTONIC ALDEHYDE	100	NS	NS	SODIUM HYPOCHLORITE	25	L	NS
CYCLOHEXANOL	100	L	NS	SODIUM HYPOCHLORITE	100 (13% CL.)	S	L
CYCLOHEXANONE	100	L	NS	SODIUM SILICATE	SOL.	S	S
DEVELOPING BATH		S	S	SODIUM SULPHITE	SOL. SAT.	S	L
DEXTRENE	SOL. SAT.	-	-	SULPHUR ACID	SOL.	S	S
DIBUTYL PHTHALATE	100	NS	L	SULPHUR ANHYDRIDE	100 (LIQUID)	S	L
DICHLOROETHYLENE	100	NS	NS	SULPHUR ANHYDRIDE	100 (DRY)	L	NS
DIGLYCOLIC ACID	18	S	L	SULPHURIC ACID	40~90	L	L
DIMETHYLAMINE	30	S	-	SULPHURIC ACID	96	NS	NS
ETHYL ACETATE	100	NS	NS	SULPHURIC CHLORIDE	100	NS	NS
ETHYL ALCOHOL	95	S	L	SULPHURYL CHLORIDE	100	NS	NS
ETHYL BENZENE	100	NS	NS	TANNIC ACID	SOL.	S	S
ETHYL ETHER	100	S	-	TARTARIC ACID	SOL.	S	S
ETHYLENE GLYCOL	CONC.	S	S	TETRACHLOROETHENE	100	NS	NS
FLUORINE	100	NS	NS	THIOPHENE	100	L	L
FORMALDEHYDE	SOL. DIL.	S	S	TIN CHLORIDE	SOL. SAT.	S	S
FORMALDEHYDE	40	S	S	TOLUENE	100	NS	NS
FORMIC ACID	1~50	L	NS	TRICHLOROETHYLENE	100	NS	NS
FURFURAL ALCOHOL	100	NS	NS	TURPENTINE (OIL)	100	NS	NS
GLUCOSE	SOL. SAT.	S	L	UREA	10	S	L
GLYCERIN	100	S	S	VASELINE		L	L
GLYCOLIC ACID	30	S	S	VINAGRE		S	S
GOLDEN SYRUP	SOL.	S	L	VINYL ACETATE	100	NS	NS
HYDROBROMIC ACID	50	-	-	WINE		S	S
HYDROCHLORIC ACID	30	L	NS	XYLENE	100	NS	NS
HYDROFLUORIC ACID	60	L	NS	YEAST	SOL.	S	L

TS = Without corrosion L = Limited corrosion NS = Corrosion

For any special application, please contact the REDI Technical Service beforehand.



Single socket pipe M/F (Self-extinguishing class B1)
Tube M/F (classe d'inflammabilité B1)
Tubo M/H (Autoextinguible class B1)

Ø (mm)	x	L (ml.)	S Thick	Reference			Note
32	x	0,25	1,8	ZT232PP	40	1.280	
32	x	0,50	1,8	ZT332PP	10	1.200	
32	x	1,00	1,8	ZT532PP	10	600	
32	x	1,50	1,8	ZT632PP	10	600	
32	x	2,00	1,8	ZT732PP	10	600	
32	x	3,00	1,8	ZT832PP	10	600	
40	x	0,15	1,8	ZT140PP	40	960	
40	x	0,25	1,8	ZT240PP	40	960	
40	x	0,50	1,8	ZT340PP	10	800	
40	x	1,00	1,8	ZT540PP	10	400	
40	x	1,50	1,8	ZT640PP	10	400	
40	x	2,00	1,8	ZT740PP	10	400	
40	x	3,00	1,8	ZT840PP	10	400	
50	x	0,15	1,8	ZT150PP*	20	800	
50	x	0,25	1,8	ZT250PP	20	640	
50	x	0,50	1,8	ZT350PP	10	480	
50	x	1,00	1,8	ZT550PP	10	240	
50	x	1,50	1,8	ZT650PP	10	240	
50	x	2,00	1,8	ZT750PP	10	240	
50	x	3,00	1,8	ZT850PP	10	240	
75	x	0,15	1,9	ZT175PP*	20	480	
75	x	0,25	1,9	ZT275PP	20	320	
75	x	0,50	1,9	ZT375PP	10	240	
75	x	1,00	1,9	ZT575PP	10	180	
75	x	1,50	1,9	ZT675PP	10	180	
75	x	2,00	1,9	ZT775PP	10	180	
75	x	3,00	1,9	ZT875PP	10	180	
90	x	0,15	2,2	ZT190PP	24	384	
90	x	0,25	2,2	ZT290PP	24	288	
90	x	0,50	2,2	ZT390PP	10	240	
90	x	1,00	2,2	ZT590PP	10	120	
90	x	1,50	2,2	ZT690PP	10	120	
90	x	2,00	2,2	ZT790PP	10	120	
90	x	3,00	2,2	ZT890PP	10	120	
110	x	0,15	2,7	ZT111PP	20	320	
110	x	0,25	2,7	ZT211PP	20	160	
110	x	0,50	2,7	ZT311PP	10	160	
110	x	1,00	2,7	ZT511PP	10	80	
110	x	1,50	2,7	ZT611PP	10	80	
110	x	2,00	2,7	ZT711PP	10	80	
110	x	3,00	2,7	ZT811PP	10	80	
125	x	0,25	3,1	ZT212PP*	10	120	
125	x	0,50	3,1	ZT312PP	1	45	
125	x	1,00	3,1	ZT512PP	1	45	
125	x	1,50	3,1	ZT612PP	1	45	
125	x	2,00	3,1	ZT712PP	1	45	
125	x	3,00	3,1	ZT812PP	1	45	
160	x	0,50	3,9	ZT316PP	1	48	
160	x	1,00	3,9	ZT516PP	1	24	
160	x	1,50	3,9	ZT616PP	1	24	
160	x	2,00	3,9	ZT716PP	1	24	
160	x	3,00	3,9	ZT816PP	1	24	



HTEM

*upon request

Double socket pipe F/F

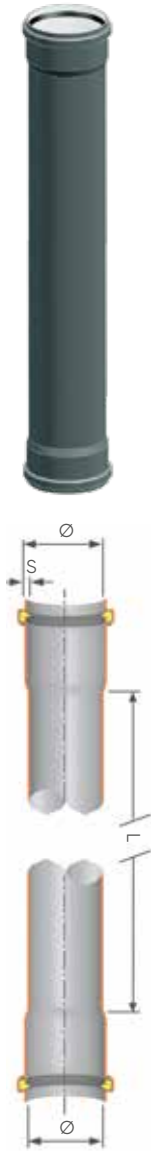
Tube F/F - Tubo H/H



Ø (mm)	x	L (ml.)	S Thick	Reference			Note
32	x	0,5	1,8	ZT333PP	10	1.200	
32	x	1	1,8	ZT533PP	10	600	
32	x	1,5	1,8	ZT633PP	10	600	
32	x	2	1,8	ZT733PP	10	600	
32	x	3	1,8	ZT833PP	10	600	
40	x	0,5	1,8	ZT343PP	10	600	
40	x	1	1,8	ZT543PP	10	1.000	
40	x	1,5	1,8	ZT643PP	10	500	
40	x	2	1,8	ZT743PP	10	500	
40	x	3	1,8	ZT843PP	10	500	
50	x	0,5	1,8	ZT353PP	10	500	
50	x	1	1,8	ZT553PP	10	720	
50	x	1,5	1,8	ZT653PP	10	360	
50	x	2	1,8	ZT753PP	10	360	
50	x	3	1,8	ZT853PP	10	360	
75	x	0,5	1,9	ZT373PP	10	360	
75	x	1	1,9	ZT573PP	10	240	
75	x	1,5	1,9	ZT673PP	10	180	
75	x	2	1,9	ZT773PP	10	180	
75	x	3	1,9	ZT873PP	10	180	
90	x	0,5	2,2	ZT393PP	10	180	
90	x	1	2,2	ZT593PP	10	240	
90	x	1,5	2,2	ZT693PP	10	120	
90	x	2	2,2	ZT793PP	10	120	
90	x	3	2,2	ZT893PP	10	120	
110	x	0,5	2,7	ZT321PP	10	120	
110	x	1	2,7	ZT521PP	10	160	
110	x	1,5	2,7	ZT621PP	10	80	
110	x	2	2,7	ZT721PP	10	80	
110	x	3	2,7	ZT821PP	10	80	
125	x	0,5	3,1	ZT322PP	1	80	
125	x	1	3,1	ZT522PP	1	45	
125	x	1,5	3,1	ZT622PP	1	45	
125	x	2	3,1	ZT722PP	1	45	
125	x	3	3,1	ZT822PP	1	45	
160	x	0,5	3,9	ZT326PP	1	48	
160	x	1	3,9	ZT526PP	1	24	
160	x	2	3,9	ZT726PP	1	24	
160	x	3	3,9	ZT826PP	1	24	

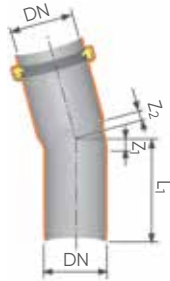

Bend 15° M/F Coude 15° M/F - Codo 15° M/H

DN (mm)	Reference			Z1 (mm)	Z2 (mm)	L1 (mm)	Note
32	Z1032PP	40	5.120	6	5	49	
40	Z1040PP	25	3.200	5	8	66	
50	Z1050PP	30	1.920	5	9	67,5	
75	Z1075PP	25	800	7	11	73	
90	Z1090PP	20	640	-	-	-	
110	Z1011PP	10	320	9	14	85	
125	Z1012PP	20	160	10	15	92	
160	Z1016PP	10	80	13	19	113	

HTB

Bend 30° M/F Coude 30° M/F - Codo 30° M/H

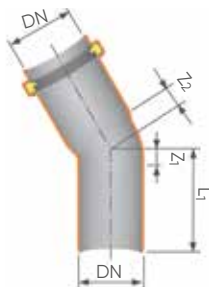

DN (mm)	Reference			Z1 (mm)	Z2 (mm)	L1 (mm)	Note
32	Z1132PP	40	5.120	6	7	52	
40	Z1140PP	25	3.200	7	11	69	
50	Z1150PP	30	1.920	9	12	71	
75	Z1175PP	25	800	12	15	78	
90	Z1190PP	15	480	-	-	-	
110	Z1111PP	10	320	17	21	92	
125	Z1112PP	20	160	19	23	100	
160	Z1116PP	10	80	24	30	123	

HTB

Bend 45° M/F Coude 45° M/F - Codo 45° M/H

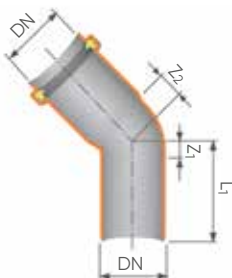

DN (mm)	Reference			Z1 (mm)	Z2 (mm)	L1 (mm)	Note
32	Z1232PP	40	5.120	8	10	55	
40	Z1240PP	20	2.560	10	14	72	
50	Z1250PP	30	1.920	12	16	74,5	
75	Z1275PP	20	640	18	21	83	
90	Z1290PP	30	480	-	-	-	
110	Z1211PP	20	320	25	29	101	
125	Z1212PP	20	160	28	33	110	
160	Z1216PP	5	80	36	42	136	

HTB

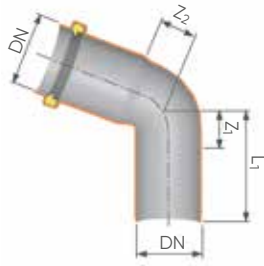

Bend 67°30' M/F

Coude 67°30' M/F - Codo 67°30' M/H

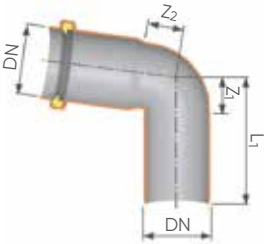

DN (mm)	Reference			Z1 (mm)	Z2 (mm)	L1 (mm)	Note
32	Z1332PP	30	3.840	13	15	60	
40	Z1340PP	20	2.560	16	20	78	
50	Z1350PP	25	1.600	20	23	81,5	
75	Z1375PP	20	640	28	31	93	
90	Z1390PP	30	480	-	-	-	
110	Z1311PP	10	160	40	44	116	

HTB



Bend 87°30' M/F

Coude 87°30' M/F - Codo 87°30' M/H

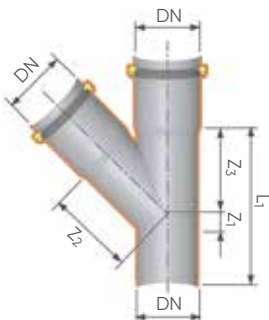

DN (mm)	Reference			Z1 (mm)	Z2 (mm)	L1 (mm)	Note
32	Z1432PP	30	3.840	14	16	62	
40	Z1440PP	20	2.560	23	26	85	
50	Z1450PP	25	1.600	28	31	90	
75	Z1475PP	20	640	40	43	105	
90	Z1490PP	25	400	-	-	-	
110	Z1411PP	15	240	57	61	133	
125	Z1412PP	20	160	65	70	147	
160	Z1416PP	10	80	83	89	183	

HTB



Branch 45° M/F

Culotte 45° M/F - Derivación 45° M/H

DN (mm)	Reference			Z1 (mm)	Z2 (mm)	Z3 (mm)	L1 (mm)	Note
32	Z3032PP	60	1.920	9	40	40	95	
40	Z3040PP	20	1.280	10	49	49	121	
50	Z3050PP	25	800	12	61	61	135	
75	Z3075PP	20	320	18	91	91	174	
90	Z3090PP	20	240	-	-	-	-	
110	Z3011PP	20	160	25	134	134	234	
125	Z3012PP	10	80	28	152	115	266	
160	Z3016PP	4	32	36	194	194	380	

HTEA

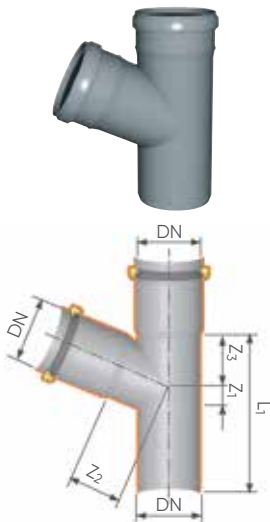
**Branch 67°30' M/F****Culotte 67°30' M/F - Derivación 67°30' M/H**

DN (mm)	Reference			Z1 (mm)	Z2 (mm)	Z3 (mm)	L1 (mm)	Note
32	Z3132PP	20	1.920	-	-	-	-	
40	Z3140PP	20	1.280	16	33	33	121	
50	Z3150PP	25	800	12	61	61	135	
75	Z3175PP	20	320	26	59	59	152	
110	Z3111PP	5	80	40	86	86	201	

HTEA

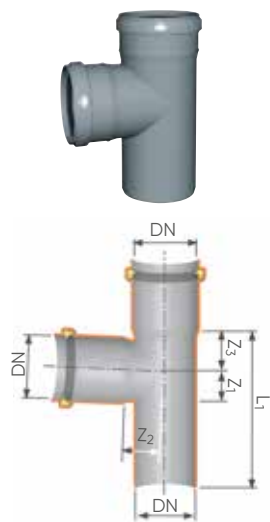
**Branch 87°30' M/F****Culotte 87°30' M/F - Derivación 87°30' M/H**

DN (mm)	Reference			Z1 (mm)	Z2 (mm)	Z3 (mm)	L1 (mm)	Note
32	Z3232PP	30	1.920	10	23	23	85	
40	Z3240PP	45	1.440	23	25	25	109	
50	Z3250PP	30	960	28	30	30	119	
75	Z3275PP	20	320	40	43	43	148	
90	Z3290PP	20	160	-	-	-	-	
110	Z3211PP	20	160	57	62	62	194	
125	Z3212PP	15	120	67	70	70	266	
160	Z3216PP	10	40	83	89	89	380	

HTEA

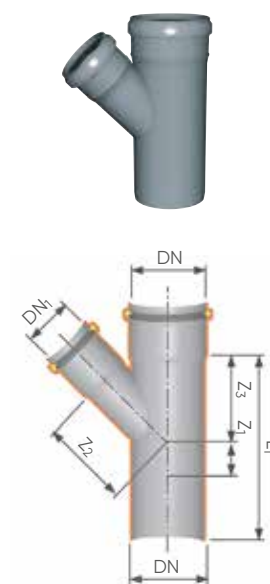
**Reduced branch 45° M/F****Culotte et embranchement 45° M/F****Derivación reducida 45° M/H**

DN/DN1 (mm)	Reference			Z1 (mm)	Z2 (mm)	Z3 (mm)	L1 (mm)	Note
40/32	Z3340PP	20	1.040	-	-	-	-	
50/40	Z3350PP	30	960	5	56	54	121	
75/40	Z3475PP	35	560	-	74	67	125	
75/50	Z3375PP	25	400	-	79	74	139	
90/40	Z3590PP	20	240	-	-	-	-	
90/50	Z3490PP	25	300	-	-	-	-	
90/75	Z3390PP	20	240	-	-	-	-	
110/40	Z3511PP	20	160	0	86	68	128	
110/50	Z3411PP	20	240	-	104	91	149	
110/75	Z3311PP	10	160	1	116	109	185	
110/90	Z3310PP	10	80	-	-	-	-	
125/110	Z3312PP	10	80	18	144	141	243	
160/110	Z3416PP	8	64	1	168	159	265	
160/125	Z3316PP	10	40	12	176	169	280	

HTEA

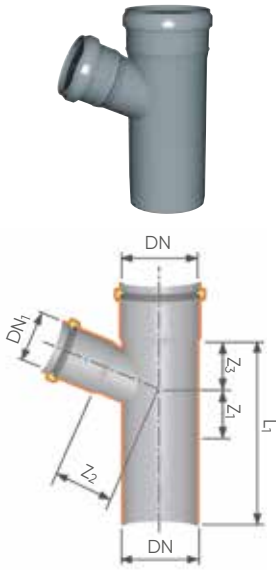

Reduced branch 67°30' M/F
Culotte et embranchement 67°30' M/F
Derivación reducida 67°30' M/H

DN/DN1 (mm)	Reference			Z1 (mm)	Z2 (mm)	Z3 (mm)	L1 (mm)	Note
40/32	Z3640PP*	20	1.920	-	-	-	-	
50/40	Z3650PP*	20	640	14	39	35	111	
75/50	Z3675PP	10	240	14	54	46	115	
110/40	Z3811PP	20	240	-	69	49	110	Fabricated
110/50	Z3711PP	5	160	8	73	54	135	
110/75	Z3611PP	20	160	22	73	67	163	

HTEA

*upon request

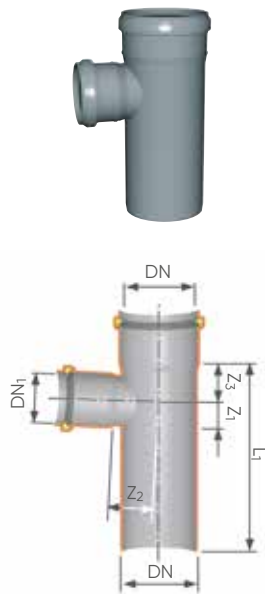

Reduced branch 87°30' M/F
Culotte et embranchement 87°30' M/F
Derivación reducida 87°30' M/H

DN/DN1 (mm)	Reference			Z1 (mm)	Z2 (mm)	Z3 (mm)	L1 (mm)	Note
40/32	Z3940PP	20	1.040	-	-	-	-	
50/40	Z3950PP*	35	1.120	23	30	25	109	
75/50	Z3975PP*	10	320					
90/40	Z4190PP	20	320	-	-	-	-	
90/50	Z4090PP	20	240	-	-	-	-	
90/75	Z3990PP	20	160	-	-	-	-	
110/40	Z4111PP	20	160	-	60	32	110	
110/50	Z4011PP	20	160	28	60	32	133	
110/75	Z3911PP	20	160	40	60	45	160	
110/90	Z3910PP	20	160	-	-	-	-	Fabricated
125/110	Z3912PP	10	80	58	69	63	204	
160/110	Z4016PP	10	60	58	86	64	237	
160/125	Z3916PP	10	60	66	87	71	280	

HTEA

*upon request

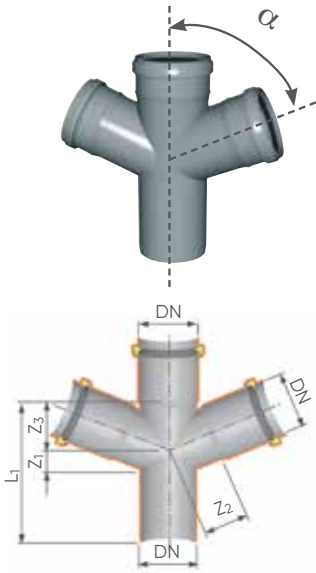

Double branch M/F
Culotte double M/F - Derivación doble M/H

DN (mm)	α	Reference			Z1 (mm)	Z2 (mm)	Z3 (mm)	L1 (mm)	Note
50	67°30'	Z4250PP*	10	640	20	41	41	124	
75	67°30'	Z4275PP	20	240	28	59	59	153	
90	87°30'	Z4511PP	8	96	-	-	-	-	
110	45°	Z4611PP	10	80	-	-	-	-	
110	67°30'	Z4211PP	5	80	40	86	86	201	
110	87°30'	Z4311PP	10	80	-	-	-	-	

HTDA
 *upon request

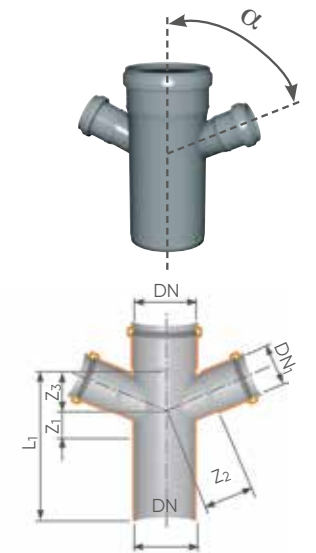

Reduced double branch M/F
Embranchement double M/F
Derivación doble reducida M/H

DN/DN1/DN1 (mm)	α	Reference			Z1 (mm)	Z2 (mm)	Z3 (mm)	L1 (mm)	Note
90/40/40	45°	Z4540PP	20	240	19	87	79	120	
90/50/50	45°	Z4550PP	20	240	-	-	-	-	
110/40/40	45°	Z4650PP	20	160	10	96	-	153	
110/50/50	45°	Z4675PP	10	120	10	92	-	153	
110/50/50	67°30'	Z4711PP	10	160	-	-	-	-	
125/110/110	45°	Z4712PP	10	80	-	-	-	-	Fabricated

HTDA

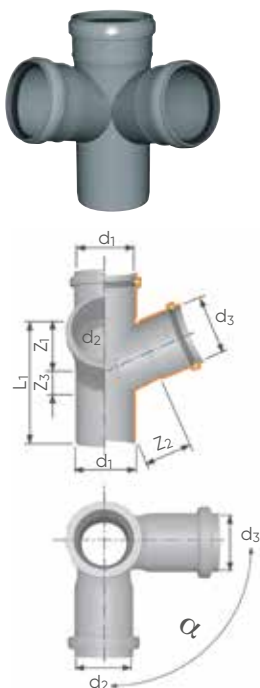

Double corner branch M/F
Embranchement double d'équerre M/F
Doble derivación escuadra M/H

d1 (mm)	d2 (mm)	d3 (mm)	α	Reference			Z1 (mm)	Z2 (mm)	Z3 (mm)	L1 (mm)	Note
110	110	110	67°30'	Z4811PP	10	80	40	86	86	202	
110	110	110	87°30'	Z4950PP	10	80	40	86	86	202	Fabricated

HTED

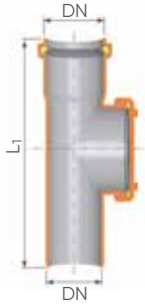

Access pipe M/F

Té de visite M/F - Te M/H con boca de registro

DN (mm)	Reference			L1 (mm)	Note
50	Z7050PP	30	960	146	
75	Z7075PP	10	320	192	
90	Z7090PP	20	240	-	
110	Z7011PP	5	160	228	
125	Z7012PP	15	120	236	
160	Z7016PP	10	80	303	

HTRE

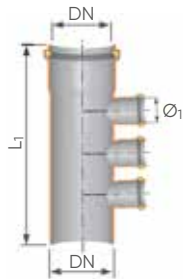

Multiple branch M/F

Culotte multiple M/F - Derivación múltiple M/H

DN (mm)	Ø1 (mm)	Connection	Reference			L1 (mm)	Note
110	40	2	Z6942PP	20	160	330	Fabricated
110	40	3	Z6943PP	20	160	330	Fabricated

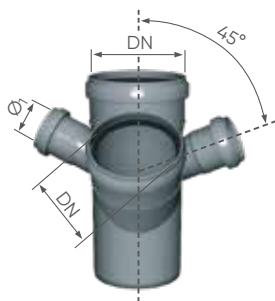



Multiple branch 45° M/F

Culotte multiple 45° M/F - Derivación múltiple 45° M/H

DN (mm)	Ø1 (mm)	Reference			Note
110	40	Z3044PP*	10	80	Fabricated



*upon request

**Repair / Slip coupler F/F****Manchon coulissant F/F - Manguito deslizando H/H**

DN (mm)	Reference			L1 (mm)	Note
32	Z6132PP	40	5.120	88	
40	Z6140PP	40	2.560	108	
50	Z6150PP	25	1.600	105	
75	Z6175PP	20	640	144,5	
90	Z6190PP	20	640	120	
110	Z6111PP	5	320	129,5	
125	Z6112PP	20	240	166,5	
160	Z6116PP	10	120	167,5	



HTU

**Coupler with central stop F/F****Manchon avec butée F/F - Manguito con tope H/H**

DN (mm)	Reference			L1 (mm)	L2 (mm)	Note
32	Z6332PP	40	5.120	88	1,2	
40	Z6340PP	40	2.560	108	1,2	
50	Z6350PP	25	1.600	105	1,2	
75	Z6375PP	20	640	144,5	1,5	
90	Z6390PP	20	640	120	-	
110	Z6311PP	12	384	126	1,5	
125	Z6312PP	20	240	166,5	2,7	
160	Z6316PP	10	80	181	3,0	

HTMM

**Socket M/F****Manchon d'adaptation M/F - Manguito adaptador M/H**

DN (mm)	Reference			L1 (mm)	L2 (mm)	Note
40	Z6540PP	25	1.600	116	163	
50	Z6550PP	40	1.280	116	165	
75	Z6575PP	35	560	122	253	
90	Z6490PP	20	240	-	-	
110	Z6511PP	20	240	124	257	
125	Z6512PP	20	160	145	221	

HTLL



Reducer M/F

Réduction M/F - Reducción M/H

d1 (mm)	d2 (mm)	Reference			L1 (mm)	L2 (mm)	Note
40	32	Z5540PP	50	3.200	-	-	
50	40	Z5550PP	60	1.920	9	103	
75	50	Z5775PP	20	1.280	-	-	

HTRR



Inside reducer M/F

Réduction incorporée M/F - Reductor interior M/H

d1 (mm)	d2 (mm)	Reference			L1 (mm)	Note
32	40	Z5440PP	10	6.400	66	
40	50	Z5450PP	10	3.840	55	

HTV



Reducer plugs M/F

Tampon de réduction M/F - Tapón reductor M/H

d1 (mm)	d2 (mm)	Reference			L1 (mm)	Note
50	75	Z5575PP	20	1.040	-	
40	90	Z5630PP	20	1.040	-	
50	90	Z5190PP	20	1.280	-	
40	110	Z5640PP	20	640	90	
50	110	Z5650PP	20	640	90	
75	110	Z5675PP	30	960	90	
90	110	Z5690PP	20	640	-	

HTV

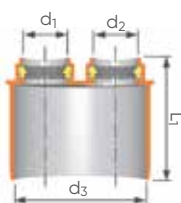

Double reducer plugs M/F

Tampon de réduction double M/F

Tapón reductor doble M/H

d1 (mm)	d2 (mm)	d3 (mm)	Reference			L1 (mm)	Note
32	40	110	Z5634PP	20	1.280	-	
40	40	110	Z5641PP	20	480	-	

HTV

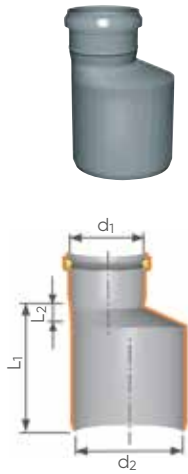
**Invert reducer M/F****Réduction excentrée M/F - Reducción excéntrica M/H**

d1 (mm)	d2 (mm)	Reference			L2 (mm)	L1 (mm)	Note
32	40	Z5040PP	20	2.800	-	-	
32	50	Z5150PP	20	1.400	12	73	
40	50	Z5050PP	20	1.280	12	73	
40	75	Z5175PP	20	1.280	26	91	
40	90	Z5290PP	20	640	--		
40	110	Z5110PP	20	640	-	-	
50	75	Z5075PP	20	1.280	20	86	
50	110	Z5111PP	15	480	40	115	
75	90	Z5090PP	20	640	-	-	
75	110	Z5011PP	15	480	26	101	
110	125	Z5012PP	20	320	15	101	
110	160	Z5116PP	20	240	34	137	
125	160	Z5016PP	20	240	27	130	

HTR

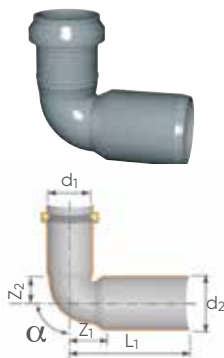
**Reducing bend M/F****Coude de réduction M/F - Codo reductor M/H**

d1 (mm)	d2 (mm)	Reference			Z1 (mm)	Z2 (mm)	L1 (mm)	α	Note
40	50	Z2650PP	20	1.280	36	26	83	87°30'	

HTBR

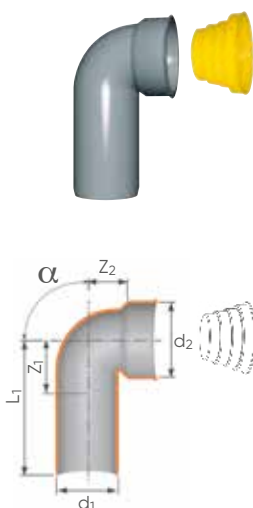
**Technical bend M/F (with protection plug)****Coude M/F (avec tampon de protection)****Codo técnico M/H (con tapa protectora)**

D

d1 (mm)	d2 (mm)	Reference			Z1 (mm)	Z2 (mm)	L1 (mm)	α	Note
50	32	Z2910PP*	20	1.040	-	-	-	-	
40	40	Z2918PP	45	2.880	26	20	89	90°	
40	50	Z2916PP	35	2.240	31	25	89	90°	
50	50	Z2915PP	35	1.120	31	25	94	90°	
50	60	Z2917PP	35	1.120	31	25	94	90°	

*Female rail with gasket / Queue femelle à joint / Compatible con Junta de goma

HTSW



Gasket

Joint - Junta de goma

D

d1 (mm)	d2 (mm)	Reference			Note
40	20÷26	6820400	50	1.000	
40	26÷32	6820401	50	12.000	
50	20÷26	6820502	50	6.000	
50	26÷32	6820500	50	6.000	
50	40	6820501	50	6.000	
60	32	ZMG32PP*	20	12.000	
60	50	ZMG51PP*	20	500	

1" = 26mm. 1"1/4 = 32 mm. 1"1/2 = 40 mm.

*upon request

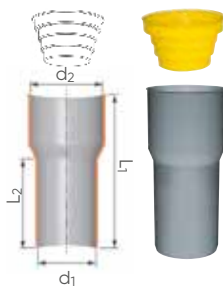

Technical Coupling M/F (with protection plug)

Manchon pour raccordements multi-matériaux M/F (avec tampon de protection)

Manguito técnico M/H (con tapa protectora)

d1 (mm)	d2 (mm)	Reference			L1 (mm)	L2 (mm)	Note
32	46	Z6810PP	20	1.040	79	50	
40	46	Z6811PP	25	1.600	93	63	

HTS

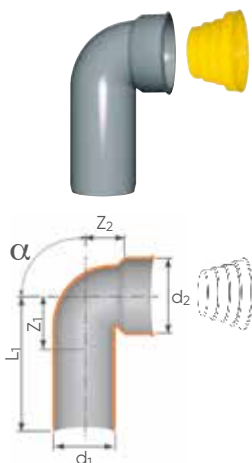

Technical bend M/F (with protection plug)

Coude M/F (avec tampon de protection)

Codo técnico M/H (con tapa protectora)

d1 (mm)	d2 (mm)	Reference			Z1 (mm)	Z2 (mm)	L1 (mm)	α	Note
32	46	Z2911PP	50	3.200	16	24	70	90°	
40	46	Z2912PP	35	2.240	17	27	76	90°	
50	46	Z2913PP	30	1.920	21	31	80	90°	

Long version / Version longue / Versión larga

40	46	Z2920PP	50	1.600	88	27	140	90°	
----	----	---------	----	-------	----	----	-----	-----	--

HTSW



Gasket

Joint - Junta de goma

d1 Ext. (mm)	d2 Int.	d3	Reference			L1 (mm)	Note
46	1" - 1 1/4"	20÷32	ZMG11PP	50	6.000	26	(1)
46	1" 1/2"	40	ZMG12PP	50	12.000	26	(2)

HTGM

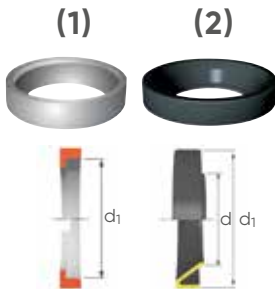

Gasket

Joint - Junta

d1 (mm)	d WC	Reference			Note
116	-	ZAB11PP	20	1.280	(1) PP White <i>PP blanc</i>
116	94÷104	ZGW12PP	10	4.160	(2) Rubber <i>Caoutchouc</i>

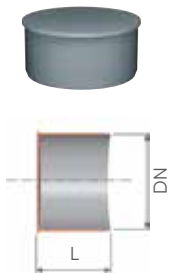

Socket plug

Bouchon de fermeture - Tapón

DN (mm)	Reference			L (mm)	Note
32	Z7132PP	20	7.680	39	
40	Z7140PP	10	7.680	39	
50	Z7150PP	20	5.120	39	
75	Z7175PP	20	2.560	39	
90	Z7190PP	30	1.920	-	
110	Z7111PP	20	1.280	46	
125	Z7112PP	20	640	50	
160	Z7116PP	10	320	58	



Rosette

Rosace - Plafón

d1 (mm)	d2 (mm)	Reference			h (mm)	Colour
90	-	0480903	20	1.620	-	White
100	137	0481003*	20	1.620	30	White
110	162	0481103	50	1.200	35	White

*upon request



WC bend M/F

Coude WC M/F - Manguito inodoro acodado M/H

DN (mm)	DN1 (mm)	Reference			L (mm)	L1 (mm)	h (mm)	Colour
110	116	Z2290PP	10	160	215	40	85	White

HTSB

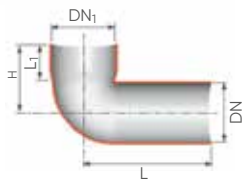

WC bend with 2 side-inlets M/F

Coude WC avec 2 entrées latérales M/F

Manguito inodoro acodado 2 tomas auxiliares M/H

Type	DN (mm)	DN1 (mm)	DN2 (mm)	Reference			L (mm)	L1 (mm)	L2 (mm)	L3 (mm)	h (mm)	Z1 (mm)	α	Colour
SX	110	116	50	Z2450PP	10	120	215	95	40	125	85	110	45°	White

DX	110	116	50	Z2405PP	10	80	215	95	40	125	85	110	45°	White
----	-----	-----	----	---------	----	----	-----	----	----	-----	----	-----	-----	-------

HTSB

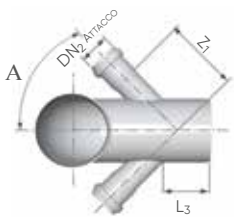
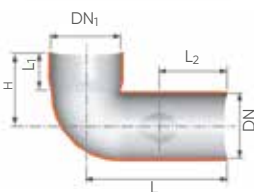

WC bend with 1 side-inlets left/right M/F

Coude WC avec 1 entrées latérales gauche/droite M/F

Manguito inodoro acodado 1 toma auxiliar derecha/izquierda M/H

DN (mm)	DN1 (mm)	DN2 (mm)	Reference			L (mm)	L1 (mm)	L2 (mm)	L3 (mm)	h (mm)	Z1 (mm)	α	Colour
110	116	40	Z2444PP*	10	80	215	100	45	130	85	110	45°	White
110	116	50	Z2455PP*	10	80	215	100	45	130	85	110	45°	White

HTSB

*upon request

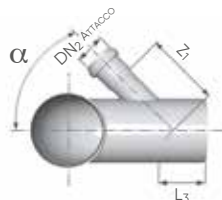
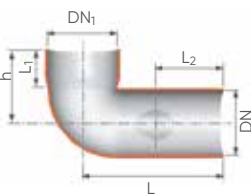

Long WC bend M/F

Coude WC haut M/F - Manguito inodoro acodado largo M/H

DN (mm)	DN1 (mm)	Reference			L (mm)	L1 (mm)	h (mm)	Colour
110	116	Z2511PP	15	120	215	140	185	White

HTSB

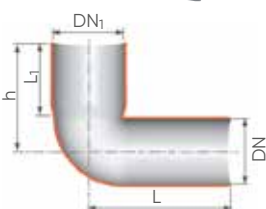

Long WC bend with 1 side inlet left/right M/F

Coude WC haut avec 1 entrée latérale gauche/droite M/F

Manguito inodoro acodado largo 1 toma auxiliar derecha/izquierda M/H



SX



DX

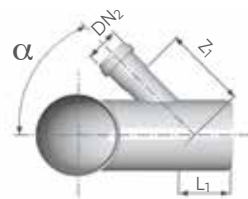
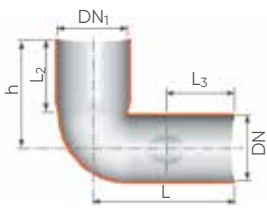

Mod	DN (mm)	DN1 (mm)	DN2 (mm)	Reference			L (mm)	L1 (mm)	L2 (mm)	L3 (mm)	h (mm)	Z1 (mm)	α	Colour
SX	110	116	40	Z2540PP	20	160	-	100	140	130	185	110	45°	White
SX	110	116	50	Z2550PP	10	80	-	100	140	130	185	110	45°	White

DX	110	116	40	Z2504PP	10	80	215	100	140	125	185	110	45°	White
DX	110	116	50	Z2505PP	10	80	215	100	140	125	185	110	45°	White

HTSB

Long WC bend with 2 side-inlets M/F

Coude WC haut avec 2 entrées latérales M/F

Manguito inodoro acodado largo 2 tomas auxiliares M/H

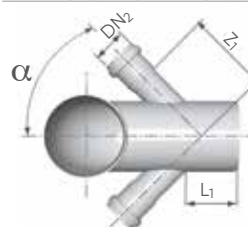
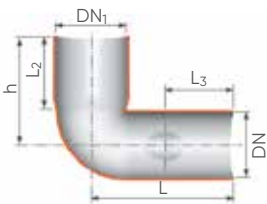

DN (mm)	DN1 (mm)	DN2 (mm)	Reference			L (mm)	L1 (mm)	L2 (mm)	L3 (mm)	h (mm)	Z1 (mm)	α	Colour
110	116	40	Z2544PP	10	80	215	100	140	125	185	120	45°	White
110	116	50	Z2555PP	20	80	215	100	140	125	185	120	45°	White

HTSB

Long WC bend with 4 side-inlets M/F

Coude WC haut avec 4 entrées latérales M/F

Manguito inodoro acodado largo 4 tomas auxiliares M/H

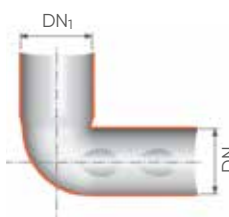

DN (mm)	DN1 (mm)	DN2 (mm)	Reference			Colour
110	116	40	Z2566PP	10	80	White

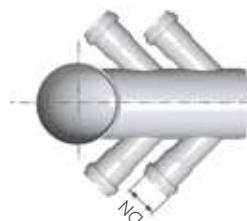

HTSB

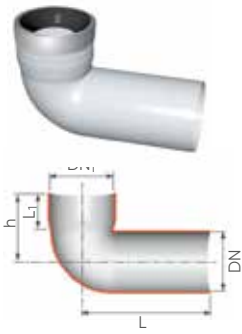

WC bend Ø90 M/F

WC long Ø90 M/F - Manguito inodoro Ø90 M/H

DN (mm)	DN1 (mm)	Reference			h (mm)	Colour
90	116	Z2090PP	10	160	85	White

HTSB

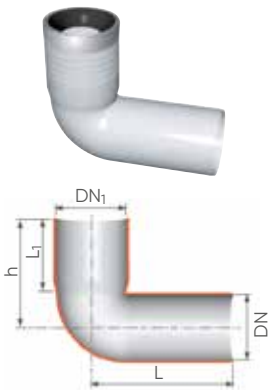

Long WC bend Ø90 M/F

Coude WC haut Ø90 M/F

Manguito inodoro acodado largo Ø90 M/H

DN (mm)	DN1 (mm)	Reference			h (mm)	Colour
90	116	Z2190PP	15	120	185	White

HTSB



Long WC bend Ø90 with 1 side-inlet left/right M/F

Coude WC haut Ø90 avec 1 entrée latérale gauche/droite M/F

Manguito inodoro acodado largo Ø90, 1 toma auxiliar derecha / izquierda M/H

Type	DN (mm)	DN1 (mm)	DN2 (mm)	Reference			α	h (mm)	Colour
SX	90	116	40	Z2140PP	10	80	45°	185	White
SX	90	116	50	Z2150PP	10	80	45°	185	White
DX	90	116	40	Z2104PP	10	80	45°	185	White
DX	90	116	50	Z2105PP	10	80	45°	185	White

HTSB

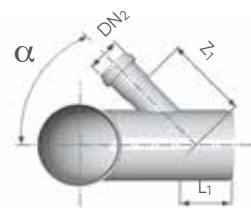
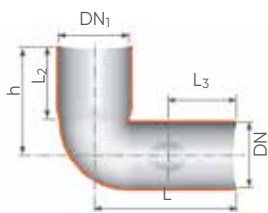

Long WC bend Ø90 with 2 side-inlets M/F

Coude WC haut Ø90 avec 2 entrées latérales M/F

Manguito inodoro acodado largo Ø90, 2 tomas auxiliares M/H

DN (mm)	DN1 (mm)	DN2 (mm)	Reference			α	h (mm)	Colour
90	116	40	Z2144PP	10	80	45°	185	White
90	116	50	Z2155PP	10	80	45°	185	White

HTSB

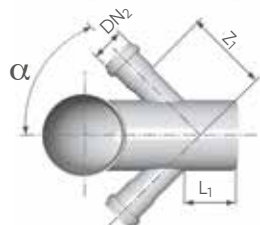
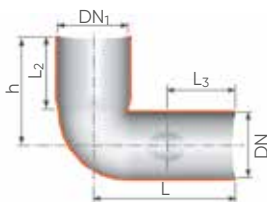

Ideal for suspended pans

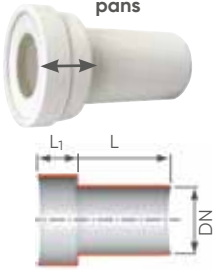

WC connector Ø90 with gasket, short socket
Manchon WC Ø90 avec joint, emboiture courte
Manguito inodoro Ø90 corto, con junta

DN (mm)	Reference			L (mm)	L1 (mm)	Colour
90	16009B3	12	288	190	40	White

WC connector Ø90 with gasket, long socket
Manchon WC Ø90 avec joint - emboiture longue
Manguito inodoro Ø90 largo, con junta

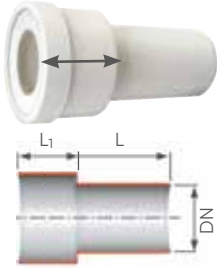

DN (mm)	Reference			L (mm)	L1 (mm)	Colour
90	16009LB	30	240	240	80	White

WC connector with gasket
Manchon WC avec joint - Manguito inodoro acodado con junta

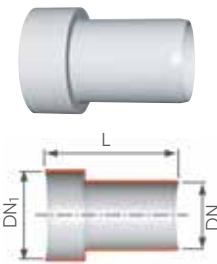

DN (mm)	DN1 (mm)	Reference			L (mm)	Colour	Note
110	116	X121503	25	160	230	White colour	
110	116	Z2711PP	15	120	390	White colour	Long

HTSK

Eccentric WC connector with gasket included
Manchon WC avec joint - sortie droite excentrée
Manguito inodoro excéntrico acodado con junta

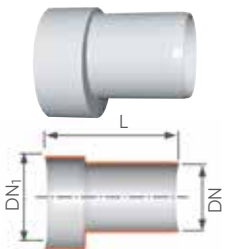

DN (mm)	DN1 (mm)	Reference			L (mm)	Colour
110	116	X121504	10	240	160	White

HTSK

Horizontal WC Bend with gasket
Pipe WC avec joint
Manguito inodoro acodado horizontal con junta

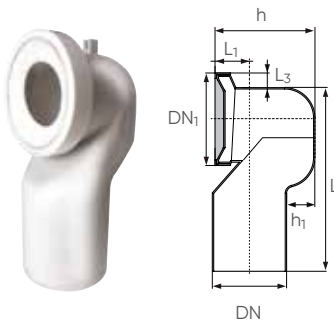

DN (mm)	Reference			L (mm)	L1 (mm)	L2 (mm)	h (mm)	h1 (mm)	Colour
90	Z2525PP	12	144	278	48	22	148	40	White
110	Z2523PP	12	144	272	51	22	148	42	White

Vertical WC Bend (PE)
Coude WC vertical (PE)
Manguito acodado para conexión de inodoro al suelo (PE)

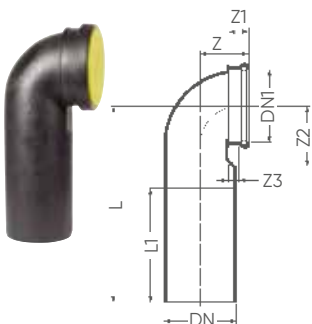

DN (mm)	DN1 (mm)	Reference			L (mm)	L1 (mm)	Z (mm)	Z1 (mm)	Z2 (mm)	Z3 (mm)	Colour
90	90	K2530PE	10	160	225	120	76	34	83	17	Black
110	90	K2531PE	10	160	225	120	76	34	95	17	Black

Adjustable trap interceptors

Siphon réglable - Sifón ajustable

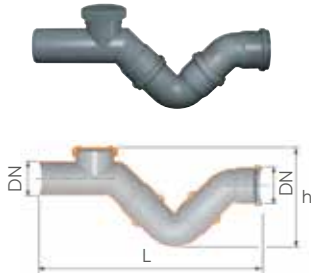

DN (mm)	Reference			h (mm)	l (mm)	Note
50	Z7850PP	10	320	144	356	
75	Z7875PP	10	120	220	480	
90	Z7890PP	10	80	-	-	
110	Z7811PP	10	80	230	521	
125	Z7812PP	5	40	250	610	
160	Z7816PP	1	-	-	-	

Low trapped floor gully

Siphonnette basse - Bote sifónico, bajo

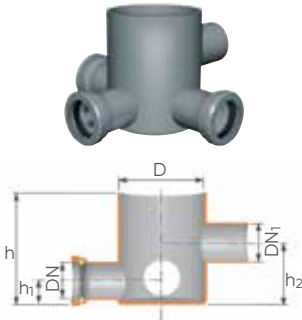

D (mm)	DN (3 inlets)	DN1 (1 outlet)	Reference			L (mm)	h1 (mm)	h2 (mm)	Note
100	40	40	Z9411PP	10	160	120	30	80	
100	40	50	Z9711PP	10	160	120	30	80	

HTSB

High trapped floor gully

Siphonnette haute - Bote sifónico, alto

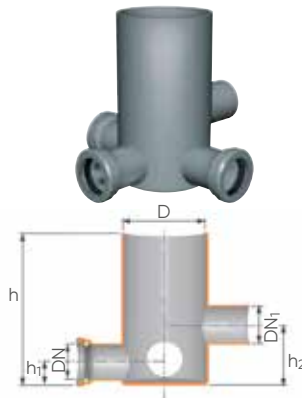

D (mm)	DN (3 inlets)	DN1 (1 outlet)	Reference			L (mm)	h1 (mm)	h2 (mm)	Note
100	40	40	Z9511PP	20	160	200	30	80	
100	40	50	Z9811PP	20	160	200	30	80	

HTSB

Inox grid with trap

Grille inox avec siphon - Rejilla con sifón en acero inox



DN (mm)	DN1 (mm)	Reference			h (mm)	Note
100	128	Z7470PP	20	800	96	

Protection cap for floor gully

Bouchon de protection pour collecteur

Tapón de protección bote sifónico



DN (mm)	Reference			Note
100	T651000	50	2.000	

Plug for floor gully with stainless steel plate

Bouchon pour collecteur avec tournette en acier inox

Tapa en acero inoxidable para bote sifónico

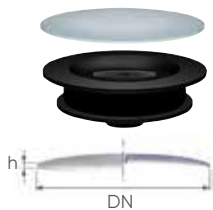

DN (mm)	Reference			h (mm)	Note
100	Z7450PP	20	1.040	3	

Accessories and Special Solutions



Sanitary Non-Return Valve



Non-return valve Ø50 PP (Type 1)

Clapet anti-retour Ø50 en PP (Type 1)

Válvula anti-retorno Ø50 PP (Tipo 1)

DN (mm)	Reference			Material	Colour	Note
50	ZVA51PP	1	432	PP	Grey RAL 7037	Push-fit system

Certifications: EN13564-1, EN1451, EN12056

Marking:



Supplied with packaging



Non-return valve Ø50 PP (Type O)

Clapet anti-retour Ø50 en PP (Type 1)

Válvula anti-retorno Ø50 PP (Tipo O)

DN (mm)	Reference			Material	Colour	Note
50	ZVA50PP	5	720	PP	Grey RAL 7037	Push-fit system



← Bi-injected flap

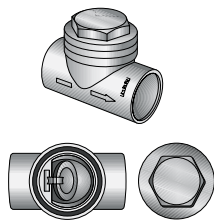

PVC Non-return valve, solvent welding version

Clapet anti-retour en PVC à coller

Válvula anti-retorno PVC, encolar

DN (mm)	Reference			Colour
32	W550302	1	-	Dark Grey
40	W550402	1	1.200	Dark Grey
50	W550502	1	720	Dark Grey
63	W550602	5	360	Dark Grey

Ideal for connection to sanitary macerators
Idéal pour sanibroyeurs



PVC Non-return valve 45°, solvent welding version F/F

Clapet anti-retour 45° en PVC à coller F/F

Válvula anti-retorno 45° PVC, encolar H/H

DN (mm)	Reference			Material
32	W600302	1	-	PVC
40	W600402	1	-	PVC
50	W600502	1	-	

Dry Condensate Trap for AC Units or Heating Pumps

Function: traps were conceived to eliminate bad smells produced in the condensate discharge hose, one of the major problems tied with recessed housings for air-conditioning units. Many traps are fitted and embedded into the wall without any possibility for the user to inspect them at a later stage.

Easy register: the cover guarantees an easy access to remove any likely obstruction (i.e. bugs or algae)

Fast inspection: thanks to its manufacturing process on a transparent material, an immediate vision of the good installation operation can be achieved inspection rapide.

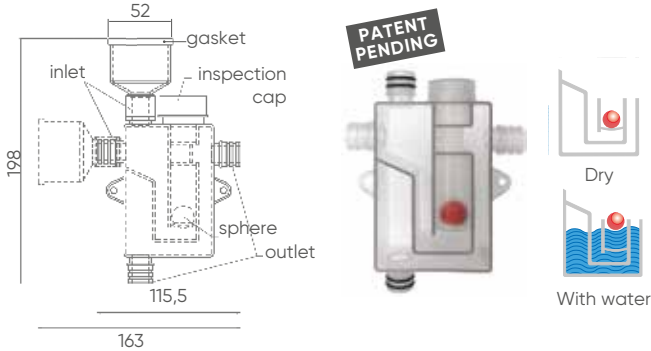
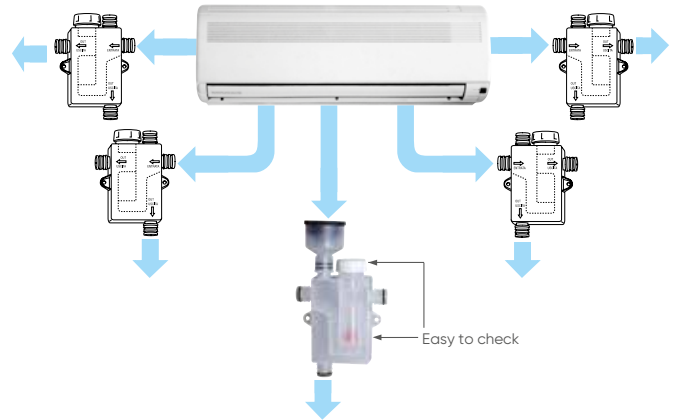

Dry condensate trap (for AC units or heating pumps)

Siphon à condensats

Sifón seco registrable para aire acondicionado

DN (mm)	Reference			Note
20-26-30	199CLPP	1	480	Kit: Gaskets - Adaptor - Sealing rings Inspection cap - Hole saw

A unique product allows multiple solutions to installation layouts
Un seul produit permet de multiples solutions d'installation



Inspection syphon with box

Siphon à condensats avec boîtier de coffrage

Sifón de condensación con caja empotrable para registro

DN (mm)	Reference			Note
20-26-30	LSSIF00	1	300	Technical gasket and inlet - Dual-purpose outlet - Watertight gasket - Piercing tool - Inspection cap



Inspection box

Boîtier de coffrage

Caja empotrable, con tapa y tornillos

DN (mm)	Reference			Note
204x239x57	LSCAT00	1	312	With lid and screws / Avec couvercle et

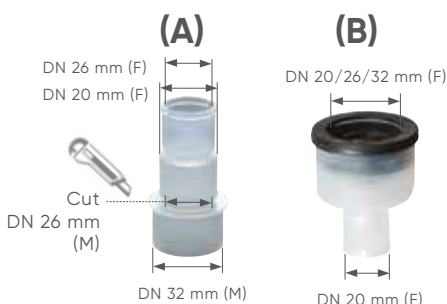

Connectors

Connecteurs

(A) Salida polivalente (B) Manguito de entrada con junta

DN (mm)	Reference			Note
26-32	Z0260PP	1	9.880	(A) Dual purpose outlet
52	Z0250PP	1	5.200	(B) Technical gasket and inlets

Air-admittance Valve for Syphons

Air-Admittance Valves (AAV) are suitable for most residential applications. They can be especially beneficial in retrofit applications where venting may be difficult. They are good for large new homes where long vent runs can be eliminated, and for kitchen island sinks.

How does an AAV work? A one-way valve that allows air into a plumbing system when there is water flow to allow drainage. Because the valve closes from internal air pressure, it seals under no-flow conditions. The valve will not open if there is positive internal pressure in the drainage system.

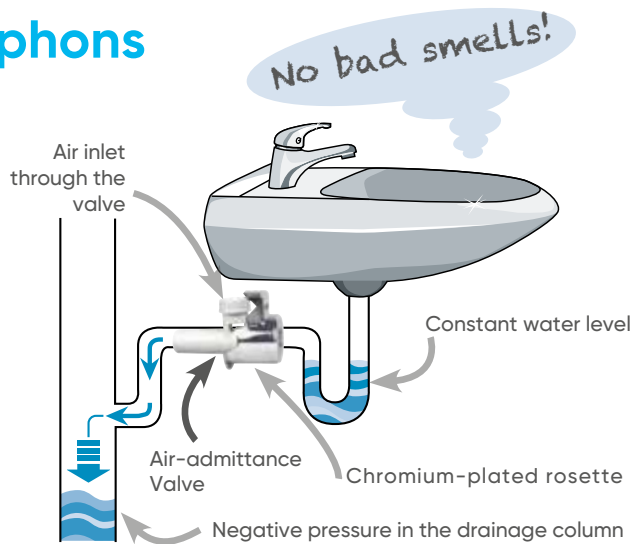

Installation guide lines



1. Remove the trap 2. Install the AAV with technical gasket 3. Connection with chromed pipe 4. Create the correct space to connect the trap



5. Fix the chromed cover 6. Connect the trap



Air-admittance valve Aérateur à membrane - Válvula de aireación

DN (mm)	DN1 (mm)	Reference			Note
32	26/32	Z5803PP	1	640	For adaptors 1"±1" ¼ / Pour adaptateurs 1"±1" ¼ Made of PP / Corp en PP No metal parts / Pas d'éléments métalliques



Chromium-plated rosette Rosette chromée - Plafon cromado

DN (mm)	Reference			Note
26 (32 e 40 preformed)	Z4803CR	1	810	Ideal for chromium-plated syphons Idéal pour siphons chromés



Air-admittance valve Ø40 (for sink and bathtub) Soupape anti-vide (pour évier et baignoire) Válvula de aireación intercalable

DN (mm)	DN1 (mm)	Reference			Note
40	40	Z5804PP	1	1.620	For adaptors 1" ½ / Pour adaptateurs 1" ½

Special Connections

"COUDIX" universal flexible sleeve (PVC) Manchette flexible universelle (PVC) Manguito flexible universal (PVC)



DN (mm)	Reference			l (mm)	L (mm)	A (mm)	Colour
32	COU3252	10	800	184	257	42	Ral 7037
40	COU4052	10	560	212	294	53	Ral 7037
50	COU5052	5	400	215	310	63,5	Ral 7037

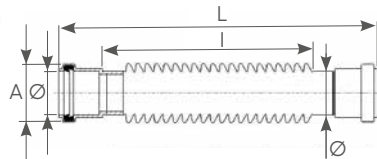

- Single piece, all **PVC made**
- Colour grey RAL 7037
- Resistant to hot temperature of household appliances and to clearing liquids
- It connects the siphon of the sanitary to the waste
- Flexibility, it can be bent beyond 180°
- By cutting off one or both the sockets with a cutter it can be used as M/F or M/M push-fit sleeve or solvent weld (use PVC glue)
- Shrinkable, suitable for maintenance and expansion joint
- Patented



Cast iron pipe adaptors (without sealing-rings) Adaptateur pour tubes en fonte (sans joint) Enlance mixto hierro fundido (sin junta)

DN (mm)	DN1 Cast iron	Reference			L (mm)	L1 (mm)	Material
50	72	Z6861PP*	20	1.280	140	70	PP
110	124	Z6863PP	15	480	158	83	PP

HTUG
*upon request



WC bend 87°30' 1 inlet left/right Coude WC 87°30' 1 entrée gauche/droite Manguito inodoro acodado 87°30', 1 toma auxiliar derecha/izquierda

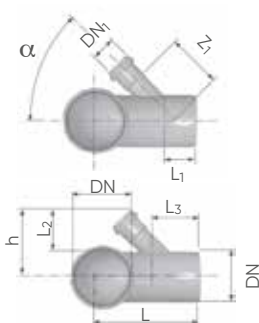

Mod	DN1 (mm)	DN2 (mm)	Reference			L (mm)	L1 (mm)	L2 (mm)	L3 (mm)	h (mm)	Z1 (mm)	α	Note
DX	110	40	Z2304PP*	20	160	161	66	68	87	138	88	45°	
SX	110	40	Z2340PP*	20	160	161	66	68	87	132	88	45°	
SX	110	50	Z2350PP	20	160	161	61	68	90	132	90	45°	

*upon request

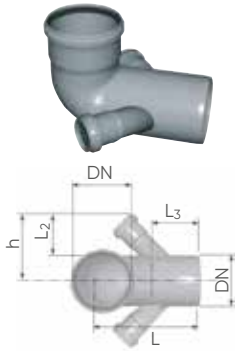

WC bend with 87°30' 2 side-inlets

Coude WC 87°30' avec 2 entrées latérales

Manguito inodoro acodado 87°30', 2 tomas auxiliares

Mod	DN1 (mm)	DN2 (mm)	Reference			L (mm)	L1 (mm)	L2 (mm)	L3 (mm)	h (mm)	Z1 (mm)	α	Note
SX-DX	110	40	Z2344PP	20	160	161	66	68	87	132	88	45°	
SX-DX	110	50	Z2355PP	20	160	161	61	68	90	132	90	45°	

WC bend with frontal inlet

Coude WC 87°30' avec 1 entrée frontale

Manguito inodoro acodado 87°30', 1 toma frontal

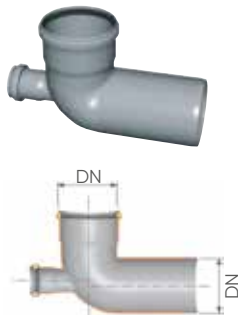

DN (mm)	DN2 (mm)	Reference			Note
110	40	Z2314PP*	20	160	

*upon request



Rosette

Rosace - Plafón

d1 (mm)	d2 (mm)	Reference			h (mm)	Colour
90	-	0480903	20	1.620	-	White
100	137	0481003*	20	1.620	30	White
110	162	0481103	50	1.200	35	White

*upon request

Multi-size technical plug

Bouchon technique multiple - Tapa protectora



DN (mm)	Reference			H (mm)	Colour	Material
40-46-50-60	OTAMUPP	1	9.600	37,5	Yellow	PP

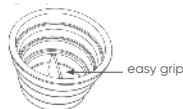
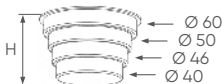

Protection plug for floor drain

Bouchon de protection pour collecteur

Tapón de protección bote sifónico



DN (mm)	Reference			Note
100	T651000	50	2.000	

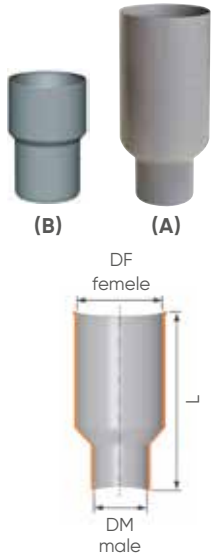

Special connectors

Connecteurs spéciaux - Manguitos especiales

Mod	DF (mm)	DM (mm)	Reference			Note
B	100	90	1790902	1	840	
A	125	100	1791102	6	-	
A	125	110	1792202	1	100	
A	140	110	1795502	8	-	
A	160	110	1797702	6	60	
A	160	125	1798802	6	60	

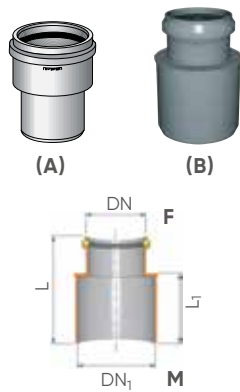

PVC-PP Adaptors / Invert reducer

Adaptateur PVC -PP / Réduction excentrée

Enlance mixto PVC-PP / Ampliación excéntrica

Type	DN F (mm)	DN1 M (mm)	Reference			L (mm)	L1 (mm)	Material
A	40	40	063558M	10	2.600	73	52	PVC
A	50	50	063568M	40	2.080	83	52	PVC
A	125	125	D501212	25	200	-	-	PVC
B	63	75	053075M	40	960	-	-	PVC
B	75	80	Z6868PP	20	940	190	78,5	PP
B	75	100	0503312	50	400	-	-	PVC
B	90	100	0531012	20	480	-	-	PVC
B	90	110	0531152	20	480	132	80	PVC
B	100	110	Z5331PP	15	480	123	66	PP
B	100	110	0533152	18	432	-	-	PVC
B	110	125	0513252	35	280	190	91	PVC

APPLICATION EXAMPLES

(1) 063558M + 0971042

(2) 063558M + 1961002

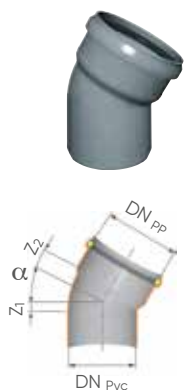
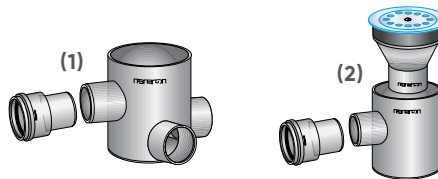

PP-PVC reducing bends

Coude de réduction PP-PVC - Codo reducción PP-PVC

α	DN PP (mm)	DN PVC (mm)	Reference			Z (mm)	Z1 (mm)	Material
15°	110	100	01011R2	15	360	15	15	PVC
45°	110	100	0041552	15	360	32	32	PVC
87°	110	100	07111R2	10	240	51	66	PVC

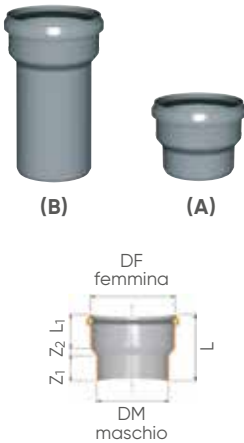

PP-PVC reducing adaptors

Adaptateur de réduction PP-PVC - Enlace reducción PP-PVC

Mod	DF (mm)	DM (mm)	Reference			Z (mm)	Z1 (mm)	L (mm)	L1 (mm)	Mat.	Note
A	75	63	0930712	15	780	-	-	-	-	PVC	O-Ring
A	80	75	0930812	20	1.040	-	-	-	-	PVC	O-Ring
A	110	90	0520952	20	480	67	10	148	90	PVC	O-Ring
A	110	100	0521152	18	432	67	10	148	90	PVC	O-Ring
A	125	100	0931212	15	360	77	18	172	102	PVC	O-Ring
A	125	110	D931112	45	360	-	-	-	-	PVC	O-Ring
B	110	100	Z6922PP	20	320	-	-	-	-	PVC	O-Ring Long



PE straight connector (with brass nut)

Connecteur en PE (avec écrou en laiton)

Enlace recto PE (con tuerca de latón)

DN (mm)	Reference			Material
40 - 1"1/4	ZP114PP	20	1.280	PE
40 - 1"1/2	ZP112PP	20	1.280	PE



PE long tail bend 87°30' (with brass nut)

Coude 87°30' longue (avec écrou en laiton)

Codo 87°30' PE (con tuerca de latón)

DN (mm)	Reference			Material
40 - 1"1/4	ZP214PP	20	1.280	PE
40 - 1"1/2	ZP212PP	20	1.280	PE



Lead / PVC-PP-PE connectors (tightening version)

Connecteur plomb / PVC-PP-PE (version à compression)

Enlace mixto plomo / PVC-PP-PE (cierre a presión)

DN lead (mm)	DN PVC-PP-PE	Reference			Colour	Material
32	32	M6103FG	20	2.560	Grey	PP
35	40	M6104FG	10	2.560	White	PP

With nut and gasket Avec écrou et joint

Lead / PVC-PP (for tin welding)**Connecteur plomb / PVC-PP (à souder à l'étain)****Enlance mixto plomo / PVC-PP (para soldadura de estaño)**

DN (mm)	Reference			Note
32	C170300	10	8.100	
40	C170400	10	2.400	
50	C180500*	10	3.240	

*upon request

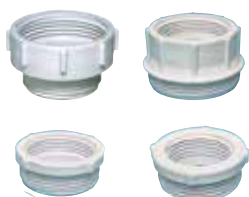
**Adapting nut****Écrou d'adaptation - Tuerca**

F x M	Ø M	Reference			Note
1"1/4 x 1"1/2		M6704FG	50	8.100	Increase / Augmentation
1"1/2 x 1"1/4		M6733FG	25	8.100	Reducer / Réduction

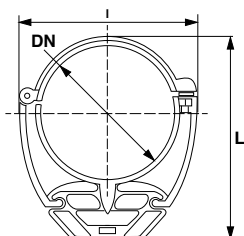
PHONOKLIP, noise-insulating support**Collier coulissant isophonique****Abrazadera acústica**

DN (mm)	Reference			Filetto Ø	L (mm)	I (mm)	Note
50	PHONK50	10	-	M8	76	78	
75	PHONK75	10	-	M8	112	111	
90	PHONK90	10	-	M8	144	131	
100	PHONK10	10	-	M7	160	140	Screws M7
110	PHONK11	10	-	M8	171	150	
125	PHONK12	2	-	M10	213	170	
160	PHONK16	2	-	M10	245	213	



Standard noise-insulating support**Collier coulissant isophonique - Abrazadera fonoabsorbente**

DN (mm)	Reference			Note
50	AV00500	2	1.800	Fixing screw included / Vis de fixation incluse
75	AV00700	2	720	Fixing screw included / Vis de fixation incluse
90	AV00900	2	720	Fixing screw included / Vis de fixation incluse
100	AV01000	2	720	Fixing screw included / Vis de fixation incluse
110	AV01100	2	720	Fixing screw included / Vis de fixation incluse
125	AV01200	2	720	Fixing screw included / Vis de fixation incluse
160	AV01600	10	360	Fixing screw included / Vis de fixation incluse



Lip ring

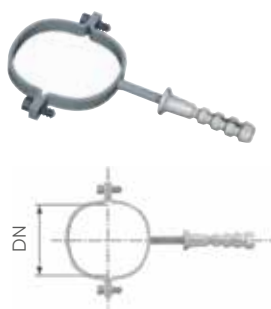

Joint à lèvre - Junta

DN (mm)	Reference			h (mm)	Note
32	7803000	1	50	6	
40	6830400	1	40.768	7,8	
50	6830500	1	29.568	7,8	
63	6800600	1	1.500	-	
75	6830700	1	13.970	7,8	
90	6800900	1	9.256	-	
100	6831000	1	7.452	-	
110	6831100	1	5.796	9,9	
125	6831200	1	3.600	10,2	
160	6831600	1	2.016	11,5	



Brackets



Colliers de fixation pour tubes - Abrazadera de tubo

DN (mm)	Ref.			Ø fixing screw	Ø anchor dim.	Note
40	ZCA40PP	50	1.800	Ø10 x 100	Ø14 x 80	Fixing screw included / Vis de fixation incluse
50	ZCA50PP	50	1.800	Ø10 x 100	Ø14 x 80	Fixing screw included / Vis de fixation incluse
75	ZCA75PP	50	1.800	Ø10 x 120	Ø14 x 80	Fixing screw included / Vis de fixation incluse
90	ZCA90PP	50	1.800	-	-	Fixing screw included / Vis de fixation incluse
110	ZCA11PP	2	1.440	Ø10 x 120	Ø14 x 80	Fixing screw included / Vis de fixation incluse
125	ZCA12PP	30	1.080	Ø10 x 120	Ø14 x 80	Fixing screw included / Vis de fixation incluse
160	ZCA16PP	10	360	Ø10 x 140	Ø14 x 80	Fixing screw included / Vis de fixation incluse



Fire collars (EN 1366-3 and ETAG 026-2)

Colliers coupe-feu - Manguito de protección contra incendios



DN (mm)	Reference			S (mm)	Note
40	K0096PE*	1	960	30	also suitable for Ø32
50	K0088PE*	1	960	30	
63	K0097PE*	1	960	30	
75	K0089PE*	1	960	30	
90	K0090PE*	1	960	30	
110	K0091PE	1	960	30	also suitable for Ø100
125	K0092PE*	1	960	30	
160	K0095PE*	1	940	30	

*upon request



Pipe insulation



Gaine d'isolation phonique - Funda de aislamiento acústico

DN (mm)	DN Pipe (mm)	S Thick.	Reference			Note
80	75 - 80 - 90	5	CD08500	6	12	15 meter-roll
110	100 - 110	5	CD11500	5	10	15 meter-roll
110	100 - 110	10	CD11100	5	-	15 meter-roll



Solvent cement THF free



Colle sans THF - Adhesivo sin THF

Pack. type	Content (ml)	Reference			Note
Tube	125	COLLA12	30	1.920	
Jar	250	COLLA25	36	1.269	With brush / Avec pinceau
Jar	500	COLLA50	24	768	With brush / Avec pinceau
Jar	1.000	COLLA00	12	432	With brush / Avec pinceau



Lubricant



Lubrifiant - Lubricante

Type	Weight (grs)	Reference			Note
Tube	150	6741500	50	1.500	
Tube	250	6742500	50	1.000	
Jar	500	6745000	12	840	
Jar	1.000	6746000	12	432	



Cleaner

Détergent - Limpiador



Type	Weight	Reference			Note
Tin	1 litre	6721100	8	384	



Chamfering tool for plastic pipes

Chanfreineur à rouleau

Achaflanadora exterior para tubos de material plástico

Ø (mm)	Reference			Note
25÷10	A080506	1	20	For 15° chamfering of PVC-PP-PE and soundproof pipes Pour chanfreinage à 15° de tubes PVC-PP-PE et acoustiques Adjustable for DN 25÷160 / Réglable pour DN 25÷160 Adjustable for thickness up to 10 mm Réglable pour épaisseurs jusqu'à 10 mm



Chamfering pipe cutter, tool box

Valise coupe-tubes chanfreineur - Maletín de corte y abocardado

Ø (mm)	Reference			Note
50-75-110	TT00100	1	20	For cutting and 15° chamfering of PVC-PP-PE end soundproof pipes / Pour coupage et chanfreinage à 15° de tubes PVC-PP-PE et acoustiques.
110-125-160	TT00200	1	-	

Adaptors for pipe cutters

Adaptateurs pour coupe-tubes

Adaptadores para cortadora de tubo de tubo



Ø (mm)	Reference			Note
100	TAD1000*	1	-	for pipe cutter Reference TT00100

*upon request



Multi-blade chamferer

Chanfreineur multi-lame - Escariador

Ø (mm)	Reference			Note
20÷50	A070506	10	810	Tempered stainless steel blades / Lames en acier inox trempé SDN: da Ø20÷Ø50 / Diamètres: Ø20÷Ø50 Both inside and outside chamfering Chanfreinage interne et externe



Conic chamferer

Chanfreineur conique - Escariador cónico

Ø (mm)	Reference			Note
32÷50	ZCS50PP	1	-	



Pipe cutting nippers

Pince coupe-tubes - Alicata corta tubos

Ø (mm)	Reference			Note
32	QA150RH*	1	32	

*upon request



Pipe cutting shears

Cisailles coupe-tubes - Tijeras corta tubos

Ø (mm)	Reference			Note
40 ÷ 63	QA160RH*	1	32	

*upon request

Ventilation AAV (Air-Admittance Valve)

REDI



Ventilation System

Products for ventilation of the waste system:

- **ARIO**
- **AAV (Air-Admittance Valve)**
- **Exhaling vent cowl**
- **Air-admittance valve for siphon bathroom/kitchen**

Purposes:

- Eliminate bad smells and avoid syphons emptying
- Reduce discharge noise
- Improve drainage capacity (flow rate)
- Speed up discharge process

Norms:

- EN 12056 Air-admittance valve systems
- EN 12380 Air-admittance valves

Examples:

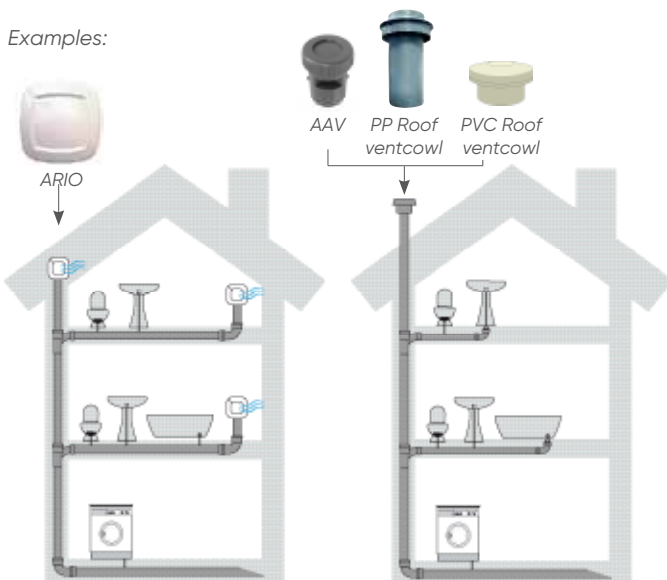

ARIO is particularly suitable for installation on concealed sanitation facilities, thanks to its design which makes it suitable to be applied in bathrooms, attics, stairwells.



The system designer has a broader flexibility of positioning and increase installation safety, thereby avoiding unexpected errors linked to pipe layout (leveling is required for other products).

ARIO what it is and what it is used for

ARIO is an AAV, which has specific features and a revolutionary operating principle.

Thanks to a pre-loaded spring, which conveys the right pressure to the gasket seal, ARIO is able to operate regardless of its installation position. This feature makes it a unique product because it can be installed both inside and outside building.



Possible installation positions: top vertical / bottom vertical / horizontal/ diagonal.

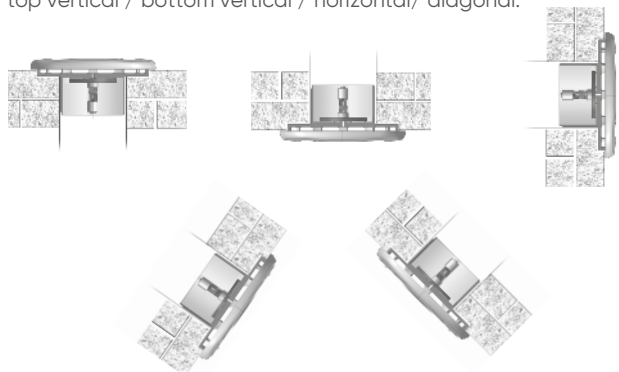

Operating position "CLOSED": it prevents bad smells emission.

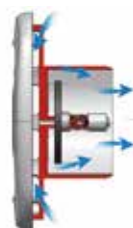

Operating position "OPEN": upon drainage, depressurization intakes air, which in turn opens the cover.

Sewage ventilation, why and how

In order to impede the expulsion of pungent odor gasses from the discharge system, the use of cut-off devices known as siphons (or traps) are integrated. The hydraulic seal generated prevents gas from escaping. There are many ways of designing a discharge system. In particular, the European standard EN 12056 describes the manner of sizing the discharge system and its relative ventilation. This standard has been implemented in Europe's main countries.

Conditions of pressurization and of depressurization come into being due to the water flow as the discharge system is operating. These pressure variations can cause problems to the traps: compression may result in trap "by-free" by the stagnant gasses, while depressurization may cause the siphon to empty (siphoning) with loss of the gas seal. Therefore, it is extremely important to compensate these effects by designing the drainage system for top efficiency, always taking ventilation into consideration. This allows drastic reduction of the pressure gradients that are generated as the system operates. System design must account both for both fluid and air flow, thus allowing these to circulate freely without acting on the siphon in undesired ways. Air intake into the discharge system can be performed by the implementation of specific devices known as ventilation chimney or ventilation valves. The use of ventilation valves allows air to enter, decreasing depressurization during discharge and that cause siphons to empty, while blocking pungent fumes from escaping.

Good design of a ventilation system allows:

- increase of discharge capacity
- reduction of noise generated during discharge
- thorough emptying of the system.

Siphoning

Siphoning is the first cause that involves emptying the traps within a building, from this point of view an effect of subordinate importance may be evaporation, that may lead to seal failure due to long periods of siphon inactivity.

The ventilation valve is a device designed to allow air intake when depressurization is generated within the system, thereby avoiding air intake by the siphons with consequential discharge.

The ARIO ventilation valve is designed to allow air intake that is suitable to the depressurization generated within the system due to the discharge flow, thus able to fully protect the siphons. As a result, this valve helps avoid the "siphoning" effect.

Without ventilation

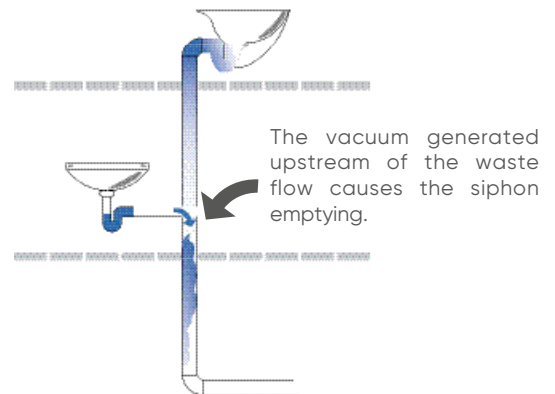

With ARIO

The air inlet compensates the vacuum generated in the waste system.

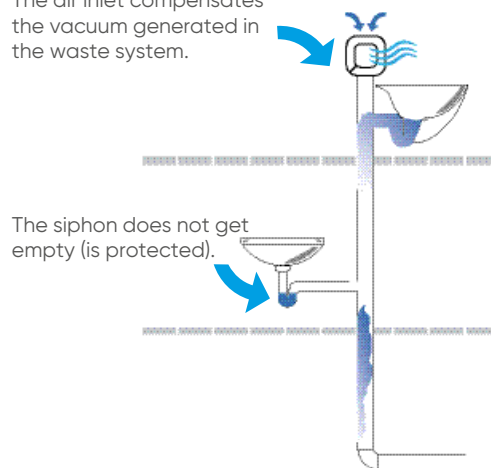

When installing a ventilation valve upstream of the horizontal section, the depressurization generated by discharge is compensated by air intake, thus protecting the sink siphon from the siphoning effect. Simultaneously, the valve remains closed to avoid release of foul odours after drainage. There are many applications for the device that must be considered during system design; however, the valve can be added to pre-existent systems. ARIO is designed to allow installation on both the secondary branches and on the main column.

Advantage of technology

One of the most important features is that ARIO, thanks to its seal tightness, allows inside installation. An example of application may be the case in which you want to avoid freeing the ventilation column through the roof outside the roof to benefit from technical and aesthetic advantages. This does not make it necessary to enter through building tops with the consequent risk of seepage. In addition, no more external chimneys are needed, which results in aesthetic advantage.

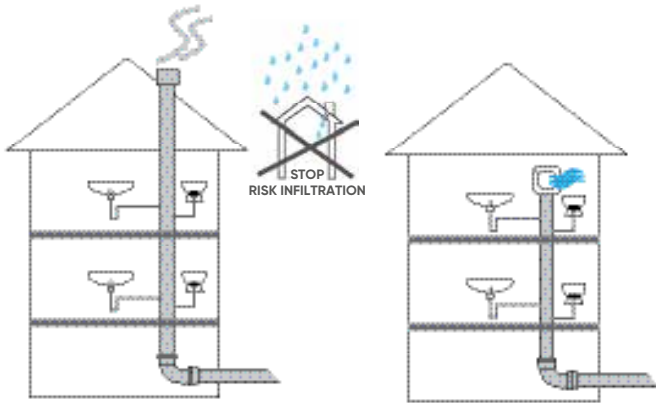

With ventilation chimney.

With ARIO ventilation valve.

Example of the advantages offered by this technology is the realization of ventilation for pre-existent systems. This can be achieved easily because using an ARIO valve means that no extension of the column, or of the branch at issue, is required. With the ARIO vent valve the installation can be performed inside the building in proximity of the manifold at issue. No floor free-through is necessary to reach the rooftop; and its design makes it perfect for bathroom installation.

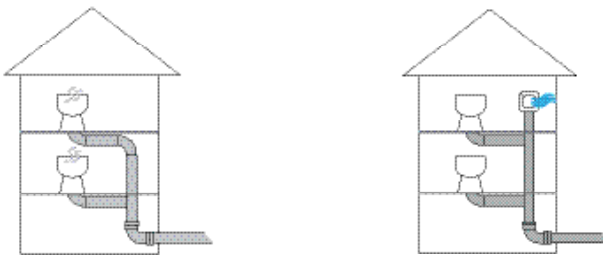

Pre-existent system with no ventilation.

Ventilation is installed with ARIO.

This makes it possible to install the air inlet inside the building, i.e. in the stairwell of a condominium, given that there are no foul odours to expel outside. Installation is also possible in cases where we are in the proximity of an opening, such as a window, which requires compliance to air intake regulations. The following example shows valve installation near a window, on the side of the building, with no problems of fumes. ARIO can be installed onto the building side in clear view thanks to its flat design and insensitivity to installation position. The valve comes in an array of available colors and can be painted. Otherwise, the ventilation chimney would have to be installed on the roof.



Example of a discharge ventilation system with ARIO next to a window.

Compared Systems Solutions

Traditional way

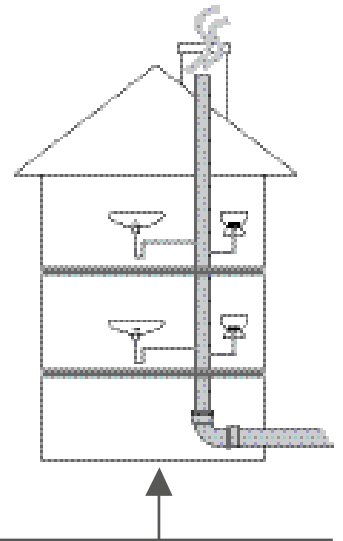

<i>Calculation example for the construction of a chimney to allow pipes to free through the rooftop.</i>	
Drill a smoke stack hole	€ 80,00
Water-proofing with 4 mm. Sheath	€ 24,00
Copper flashing to protect hole	€ 100,00
Protection chimney	€ 200,00
Total	€ 404,00
<small>The costs refer to realized installations - source data of 2011 Italy</small>	

Venting with ARIO

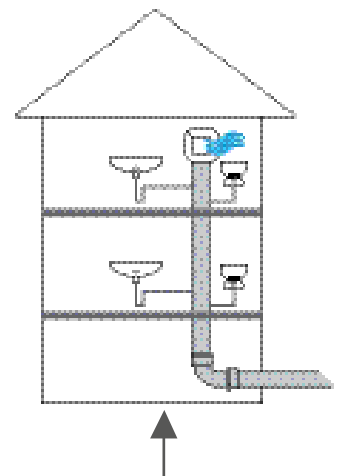

When a discharge system is designed using a vent valve such as ARIO, **no additional costs** are necessary.
 For example: a valve can be installed in the attic.
 Aside from avoiding a series of installation-linked complications, water seepage from the roof is no longer a problem.

Technical Application

Below are represented a series of system layouts suitable to different system needs and typologies. The purpose is to outline several possible applications, not all those obtainable. Sizing must be executed in compliance with the reference regulations and local laws. An international standard accepted throughout Europe is EN 12056 that provides indications on discharge system sizing.

Diagram 1

Pressure regulation in the discharge column can be achieved by means of a venting channel; alternatively, a ventilation valve may be installed.

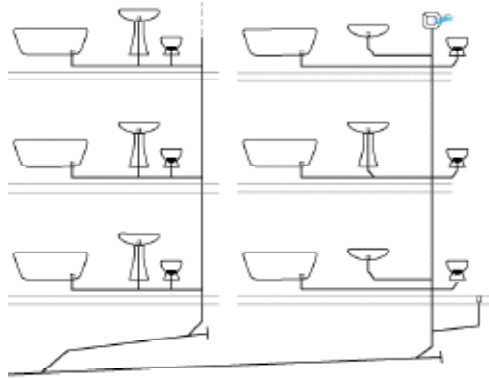

Diagram 2

Pressure control in the discharge branch can be achieved by means of a ventilation valve.

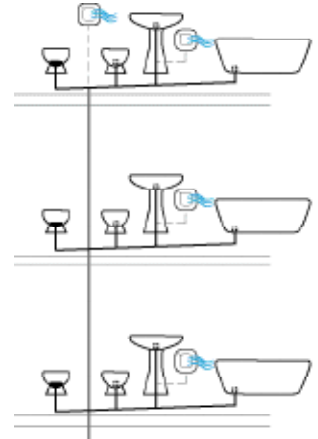

Diagram 3

Different ways of installing a ventilation systems. The use of a ventilation valve greatly simplifies the installation scheme, thus avoiding rooftop free-through while keeping the same efficiency.

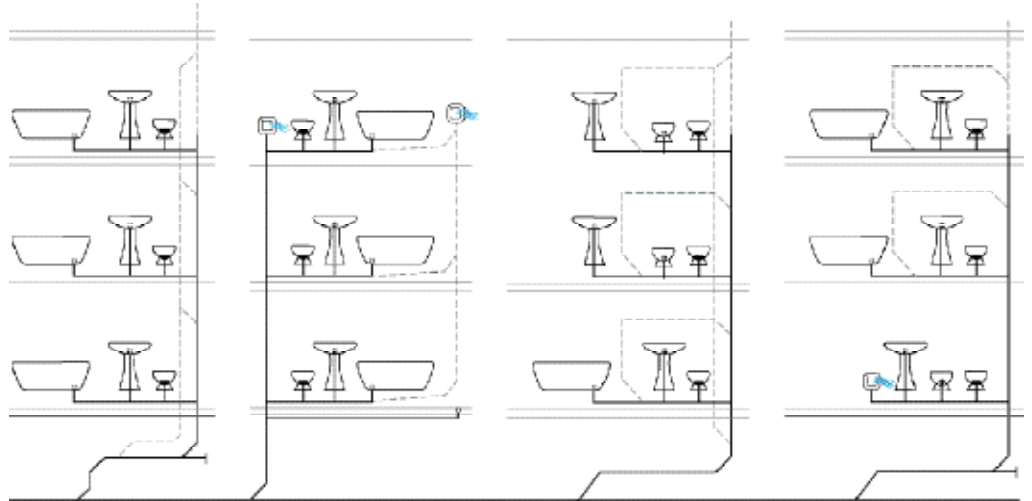
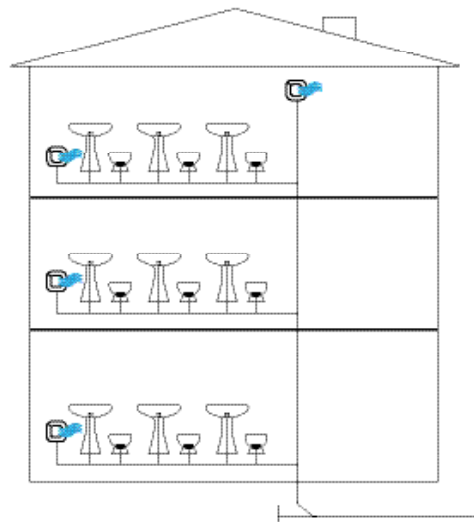

Diagram 4

ARIO vent can be considered as an effective solution for the ventilation of sequentially-installed systems (i.e. in tower buildings such as offices, schools, barracks) in a column of non-direct auxiliary ventilation. The system proves to be much simplified this way.



CE Marking

Ario

Air-admittance valves for drainage systems

EN 12380

Specifications:

- Name: **A II**
- Air flow capacity: **14 l/s**
- Air seal tested at: **10 KPa**
- Range of operating temperature: **from 0°C to 60°C**
- Subzero temperature performance: **NPD**

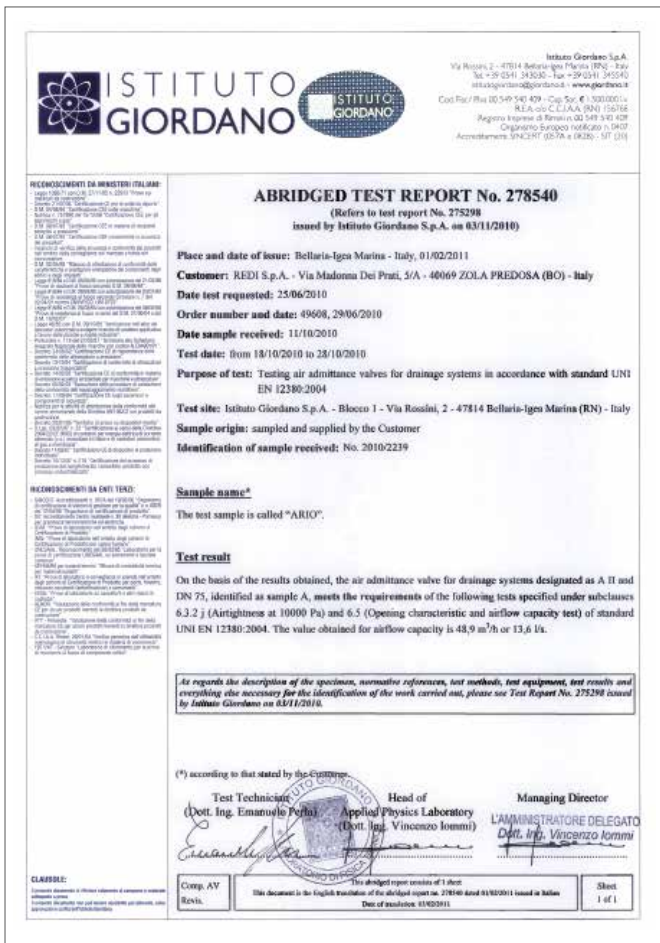

Certificate "ISTITUTO GIORDANO"

The certificates shown on this catalogue may be subject to revisions. Updated certificates for each product are available on website www.redi.it

Technical Specifications

The outside cover of ARIO can be removed when needed, to either allow verification of the proper operating conditions of the sealing disc, or look for any obstructions. This disc can be removed from its seat for further inspection.

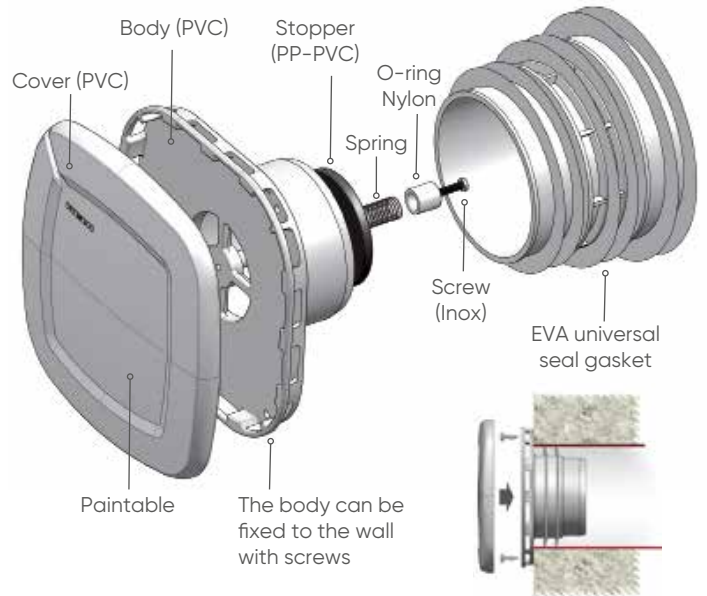

ARIO is designed to be installed through coupling. The valve can be directly inserted when dealing with Ø75 pipes (glue to a PVC) pipe. A special gasket is designed to allow fitting to a wide range of diameters – from Ø75 to Ø114.

The gasket is made of highly resistant EVA material and its shape makes it suitable to be trimmed to the desired diameter.

Assembling of the universal gasket (EVA)

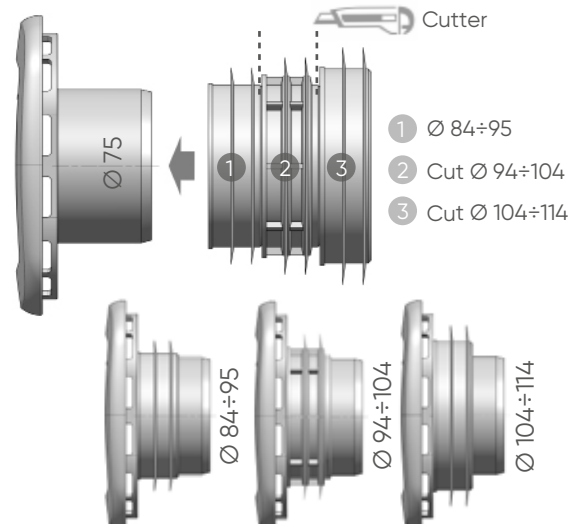





Ario

AAV - primary ventilation (universal, diameter range: Ø75 ÷ Ø114)

Soupape anti-vide (Ø75 ÷ Ø114)

Válvula de aireación (diámetro universal rango: Ø75 ÷ Ø114)

Dim. (mm)	Reference			Type	Note
146,6 x 146,6	169000W	1	306	White	universal gasket included
146,6 x 146,6	1690007	1	306	Dark brown	universal gasket included

Available in single package, also including universal gasket

Adaptor required: Ø84÷95; Ø94÷104; Ø104÷110

For the kitchen, Ø75 can be directly inserted.



Dark brown

Universal, diameter range:
Ø 75 ÷ Ø 114

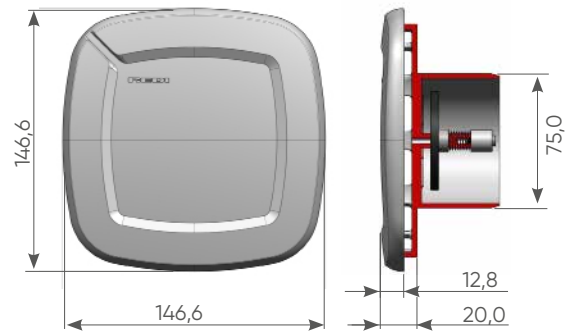

EN 12380 ¹⁰

- Description: **A II**
- Airflow rate: **14 l/s**
- Air tightness tested at: **10 KPa**
- Temperature range: **0°C at 60°C**
- Effectiveness at low temperature (below zero): **NPD**

Packaging: display box (9 piece-box)



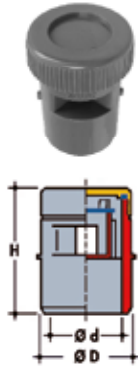

PVC Air-admittance valve (AAV)

Clapet à membrane en PVC - Aireador de membrana en PVC

DN M - F	H (mm)	Reference			Note
40 - 32	68	WAM430M	1	2.880	
63 - 50	84	WAM650M	1	240	
80 - 75	87	WAM870M	1	1.040	
110 - 100	132	WAM110M	1	480	

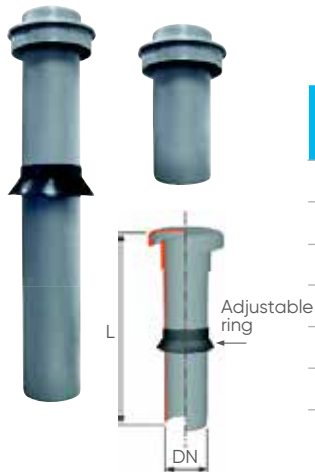

PP Ventpipe

Cheminée de ventilation de colonne en PP
Sombrete de ventilación PP

DN M - F	Reference			L (mm)	Note
50	Z7950PP	10	180	800	long version
75	Z7975PP	5	120	800	long version
110	Z7911PP	5	45	800	long version
50	Z8050PP	20	320	280	short version
110	Z8011PP	10	120	280	short version

PVC Roof ventcowl

Chapeau de ventilation en PVC - Sombrete de ventilación PVC

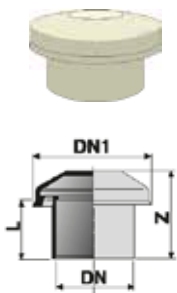

DN (mm)	DN1 (mm)	Reference						L1 (mm)	Z (mm)
		Ivory RAL 1013	Orange RAL 2003	Brown RAL 8017	Grey RAL 7035				
50	137	1690503	-	-	1690502	5	900	36	120
63	137	1690603	-	-	1690602	5	850	38	64
75	-	-	-	-	1690702	20	700	-	-
80	137	1690803	-	1690807	-	-	-	46	69
82	-	1698203	-	-	-	5	500	-	-
100	162	1691003	1691009	1691007	1691002	15	360	56	84
110	178	1691103	-	-	-	10	300	61	89
125	162	1691203	-	-	-	10	300	60	165

Ventilation Professional solution for ventilation

REDI

1.5 VENTILATION



The New Air System

Grill with removable winged insert

All ventilation grills consist of two different parts: one is perimetrical and the other one is central (with wings) and removable in order to remove easily mosquito mesh. You have to check at least once time per year to inspect the pipe.

Round built-in grills

To remove the grill it is sufficient to rotate anticlockwise holding the wings and extracting.



Round push-in grills - PATENTED

To remove the grill it is sufficient to rotate anticlockwise holding the wings and extracting.



Square push-in grills - PATENTED

To remove the grill to insert the screwdriver in the special slit and to extract it without forcing.



The grills have the same air flow with or without the mosquito mesh

Grills with fly mesh always permit the same air flow of the one without fly mesh. That's possible because uses a 70% open section grid that warrants an air flow always superior to the one it is linked to. The final air flow is not reduced. Because the grid is distanced from the wings. Therefore we can affirm that all ventilation grills have the same air flow.

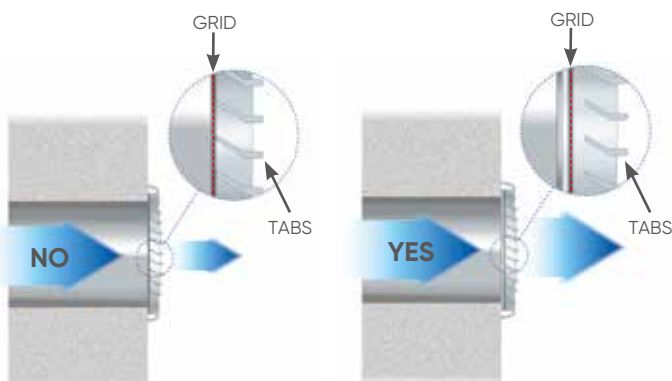

30° Inclined tabs

The wings of the grill have 30° inclination in order to permit the maximum air flow and to be rain proof.



Materials and colours

Grills are made with:

- **ABS** shock resistant with additive anti UV in order to guarantee a greater resistance to sun rays.
- **Colours:** White, Copper
- **PVC** the structure and the materials are particularly resistant and it permits the use of grills in places subject to shocks.
- **Colours:** Grey, Brown

Aluminium mosquito mesh with 70% open section

In grills uses aluminium insect proof grid with 70% open section, in order to permit a high air flow, superior to the one of the grill. The mosquito mesh is not electrostatic; which means it doesn't attract dust, unlike the plastic ones that favour obstruction.

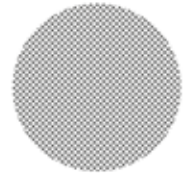

Design - Models - Dimensions - PATENTED MODELS

The round shape grills has been projected to differentiate the product and to confer to the structure a greater shock resistance. The range of products and their dimensions have been examined to meet all customer's requirements.

Screw fixing

All grills can be fixed with screws. Inside the perimetrical side of the grill there are some holes that can be seen only taking off the winged part. In this case the spring support must be removed.

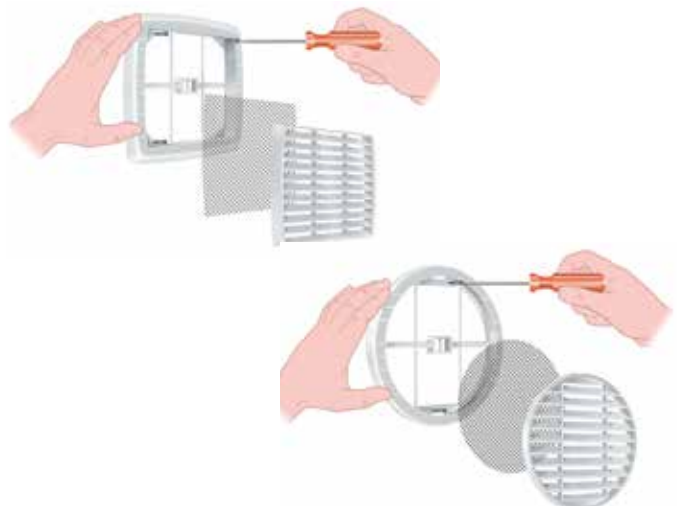

Spring fixing - PATENTED

For a quick installation, grills have a carriage spring fixed to a foldable support that blocks during the period of use. This kind of spring permit to apply the grill to pipes or holes with different diameters. When the hole is too close to the floor or to the ceiling, and is not installed in central axe with the grill, only one part of the spring can bend compensating the offset.



Example of installation

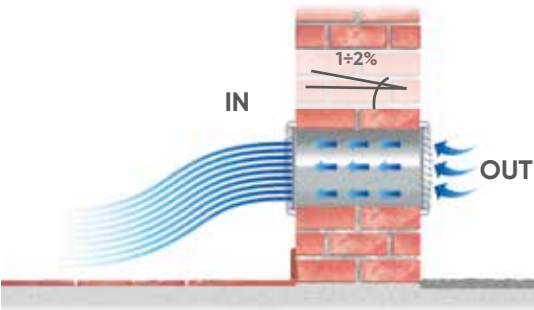

Silicone fixing

For permanent fixing or water insulation, you can seal the exterior edge of the grill with silicone without compromising the possibility of extracting the winged part and the grid.

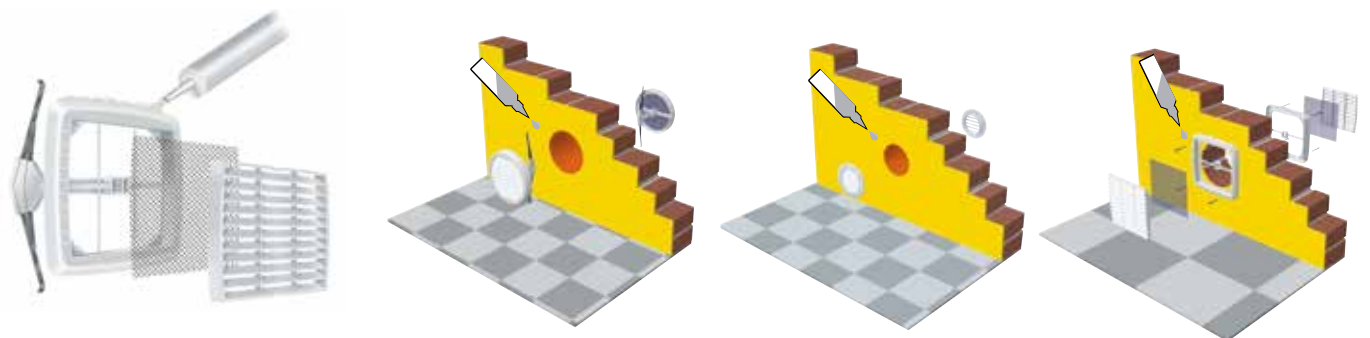

Technical characteristics

Proprietà	Test	Size	Result
Mechanical characteristics:			
Shock resistance IZOD with 3,2 mm cut	ISO R180/4A	j/m	190-250
Thermic characteristics:			
Vicat softening temperature	ISO 306/A 120 (10N)	°C	106-108
	ISO 306/B 120 (50N)	°C	98-100
HDT deflection temperature	ISO 75 1,82 N/mm ²	°C	98-100
	ISO 75 0,45 N/mm ²	°C	102-104
Thermal linear expansion coefficient	DIN 53752	10 ⁻⁴ /K	0,8-1,1
Flaming:	IEC 695 2-1	°C	650

How to clean



Ventilation

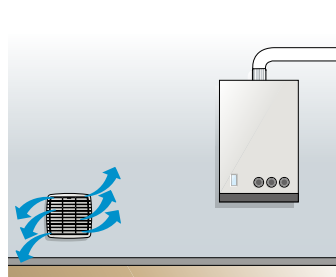

Aeration

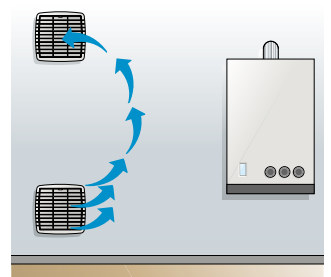

Guidelines













VENTILATION

(without presence of gas devices)

Air flow min. cm² 120

UNI CIG 7129/92



<p>Free air cm² 14</p> <p>Built-in round grilles Ø 63</p>  <p>PIPE Ø 63 Free air cm² 28</p> 	<p>Free air cm² 25</p> <p>Built-in round grilles Ø 80</p>  <p>Free air cm² 47</p> <p>Round push-in vents Ø 135</p>  <p>PIPE Ø 80 Free air cm² 47</p> 	<p>Free air cm² 42</p> <p>Built-in round grilles Ø 100</p>  <p>Free air cm² 60</p> <p>Round push-in vents Ø 135</p>  <p>PIPE Ø 100 Free air cm² 73</p> 	<p>Free air cm² 64</p> <p>Built-in round grilles Ø 125</p>  <p>Free air cm² 60</p> <p>Round push-in vents Ø 135</p>  <p>PIPE Ø 125 Free air cm² 115</p> 	<p>Free air cm² 100</p> <p>Round push-in vents Ø 160</p> 	<p>Free air cm² 115</p> <p>Square push-in vents 175</p> 
---	---	---	---	--	---

Air flow cm² 120

Air flow cm² 120

Air flow cm² 180

Air flow cm² 200



Free air cm² 100

Free air cm² 130

Free air cm² 130

Free air cm² 130

Free air cm² 130

Free air cm² 188

Free air cm² 188

Free air cm² 210

Free air cm² 200

Round push-in vents
Ø 160

Round push-in vents
Ø 186

Square push-in vents
⌀ 175

Round push-in vents
Ø 186

Square push-in vents
⌀ 175

Square push-in vents
⌀ 210

Rectangular surface
mounted vents
⌀175x270

Round push-in vents
Ø 230

Square push-in vents
⌀210

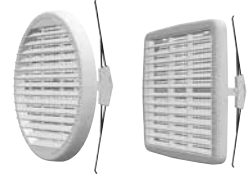
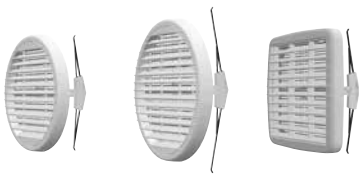

PIPE
Ø 140
Free air
cm² 144

PIPE
Ø 160
Free air
cm² 188

PIPE
Ø 200
Free air
cm² 294



Guidelines

AIR SYSTEM:

- Acoustic ventilation solution
- Ventilation grills

Functions:

- Allow change of ambient air.
- Compling with the safety norms related to kitchens or boiler rooms.
- Compling with the norms related to ambient noise limit.

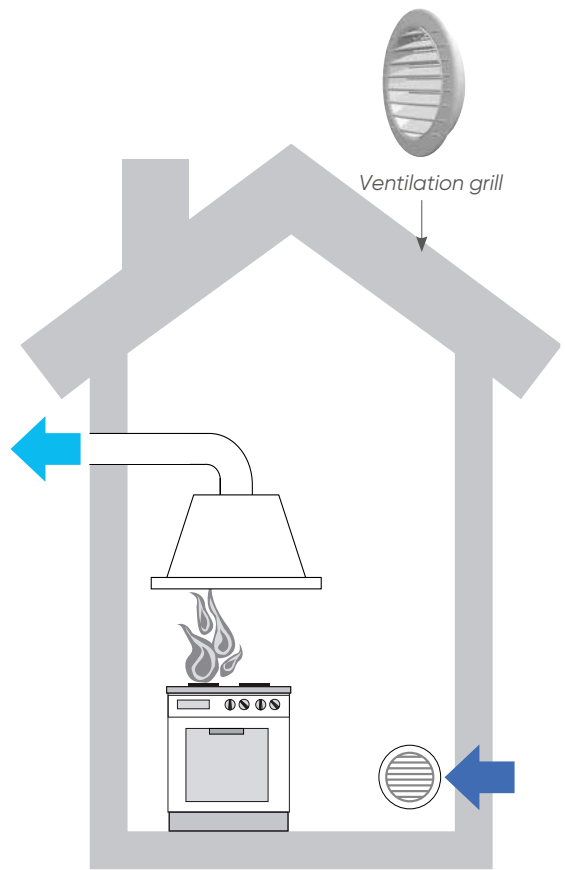

Acoustic solution for ventilations

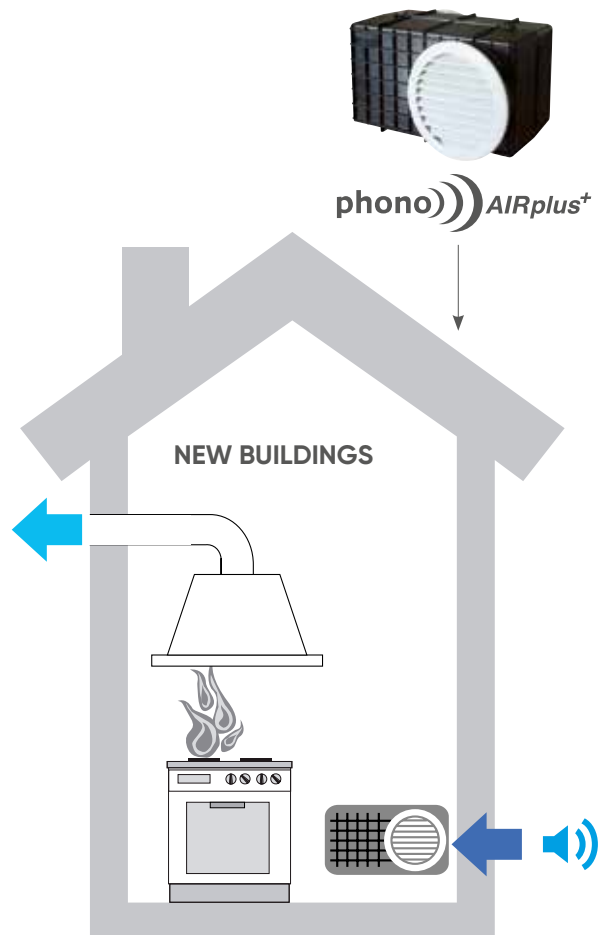
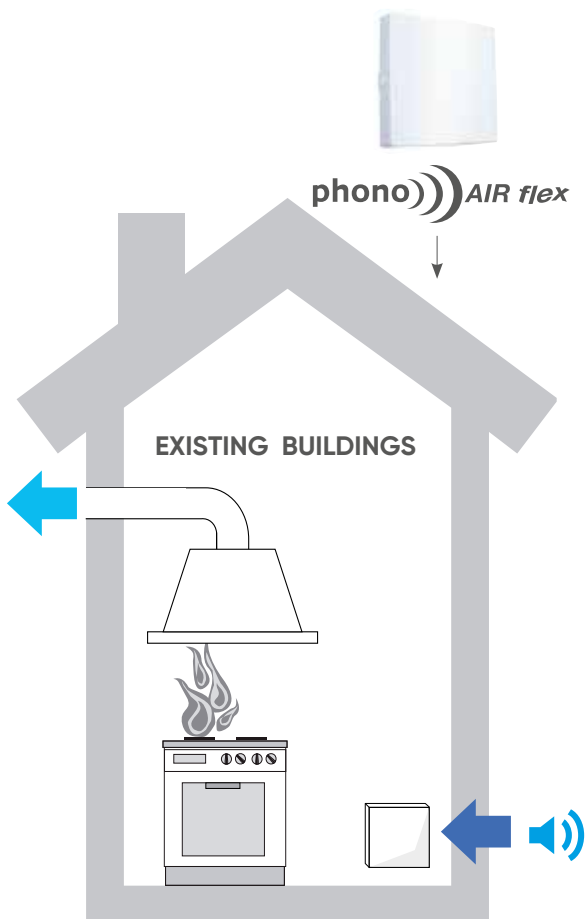



phono))) AIRplus+

Sound-proof air kit

Echangeur d'air avec abattement acoustique
Intercambiador de aire con reducción acústica

Dim (mm)	Reference			Colour
350x200x165	1PA1608	1	48	Black



Air Flow
100 cm²



-47 dB



Included in the package:

- 2 pcs. grids Ø160 with mesh (inspectable)
- Protective cover
- Extension pipe not included

Advantages:

- Compact (10,8 LT)
- Reinforced box
- No maintenance

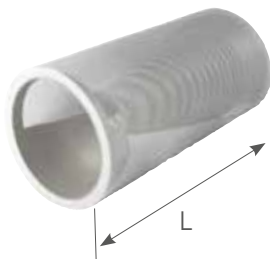
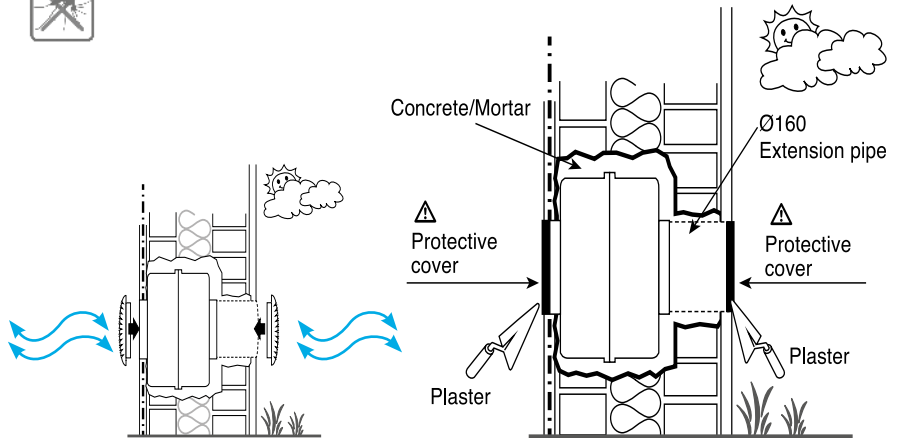
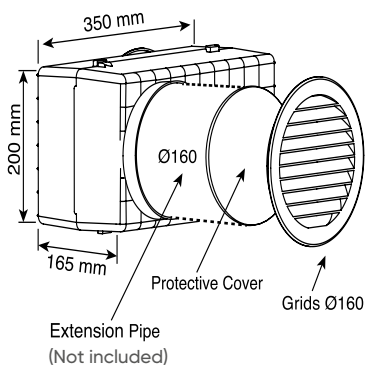

-42 dB

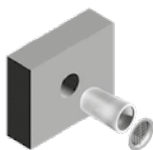

EUSTACHIO 160

Eustachio))) 160

Ø (mm)	L (mm)	Reference			Note
150	288	EPA0603	1	1.296	Colour white

Air flow 100 cm²

Inserted in the ventilation pipe Ø160

Ideal for renovation projects in existing buildings.

N.B.: Built-in round grille Ø160 not included



Acoustic ventilation grill

Grille de ventilation acoustique - Rejilla de ventilación acústica

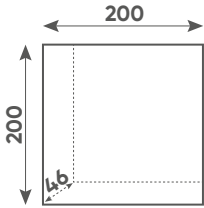

Multidiameter
80 ÷ 140 mm



Air Flow
100 cm²



-32 dB



Dim (mm)	Reference			Colour	Note
200x200	EPAGF03*	1	240	White	Multidiameter Ø: 80-100-125-140 mm Supplied with screws and gasket

*upon request

Spare parts: screw

Reference			Note
EKVGFO0*	30	-	

*upon request

Technical features:

- Made of ABS (UV resistant)
- Air flow: 100 cm² (UNI CIG GAS)
- Certified acoustic performance: -32 dB
- Double density noise insulation
- Aluminium net (anti insects and dust)
- Multi diameter: (80, 100, 125, 140 mm)
- Suitable for indoor and outdoor installations
- Integrated spirit level to the right installation
- Screws included



Bathrooms & rooms with boilers



Kitchens

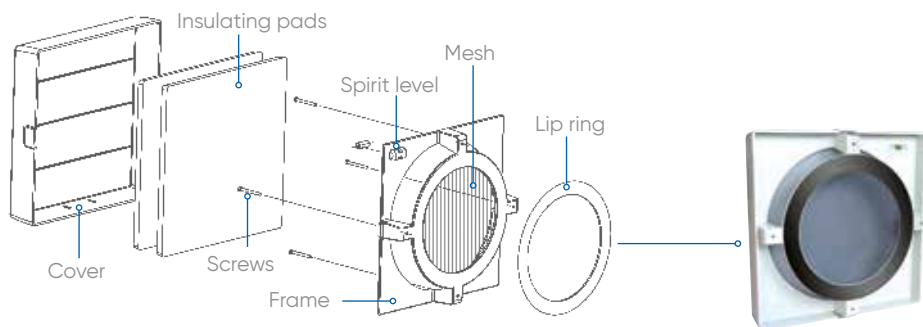

Installation sequence:



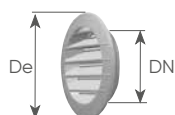

AIR FLOW: 14 cm²

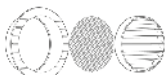

Easy inspection



Built-in round grille Ø63
Grille ronde à sceller Ø63 - Rejilla empotrable Ø63

DN (mm)	De (mm)	Colour	Reference			Note
63	80	White	E06TIO5	10	2.400	With removable mosquito mesh

Thermo shrinking

DN (mm)	De (mm)	Colour	Reference			Note
63	80	White	E06TIG5	10	2.160	With removable mosquito mesh

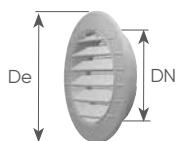

AIR FLOW: 25 cm²



Easy inspection



Built-in round grille Ø80
Grille ronde à sceller Ø80 - Rejilla empotrable Ø80

DN (mm)	De (mm)	Colour	Reference			Note
80	100	White	E08TIO5	10	2.400	With removable mosquito mesh

Thermo shrinking

DN (mm)	De (mm)	Colour	Reference			Note
80	100	White	E08TIG5	10	2.400	With removable mosquito mesh

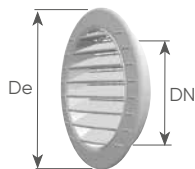

AIR FLOW: 42 cm²



Easy inspection



Built-in round grille Ø100
Grille ronde à sceller Ø100 - Rejilla empotrable Ø100

DN (mm)	De (mm)	Colour	Reference			Note
100	120	White	E10TIO5	10	1.440	With removable mosquito mesh
100	120	Copper	E10TIO*	10	1.440	With removable mosquito mesh

Thermo shrinking *upon request

DN (mm)	De (mm)	Colour	Reference			Note
100	120	White	E10TIG5	10	1.440	With removable mosquito mesh

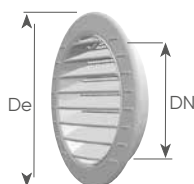

AIR FLOW: 64cm²



Easy inspection



Built-in round grille Ø125
Grille ronde à sceller Ø125 - Rejilla empotrable Ø125

DN (mm)	De (mm)	Colour	Reference			Note
125	140	White	E12TIO5	5	960	With removable mosquito mesh

Thermo shrinking

DN (mm)	De (mm)	Colour	Reference			Note
125	140	White	E12TIG5	1	960	With removable mosquito mesh

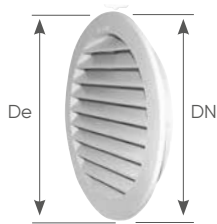
AIR FLOW: 120 cm²**Built-in round grille Ø160****Grille ronde à sceller Ø160 - Rejilla empotrable Ø160**

DN (mm)	De (mm)	Colour	Reference			Note
156	190	White	V16TI05	5	600	

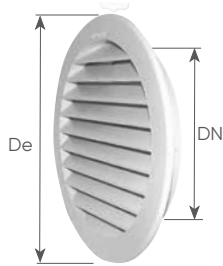
AIR FLOW: 132 cm²**Built-in round grille Ø200****Grille ronde à sceller Ø200 - Rejilla empotrable Ø200**

DN (mm)	De (mm)	Colour	Reference			Note
200	238	White	V20TI05	3	-	

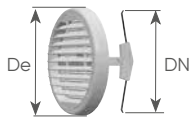
AIR FLOW: 60 cm²**Round push-in vent Ø135 (type 100)****Grille ronde avec ressort de fixation Ø135****Rejilla circular conexión a presión Ø135**

De (mm)	DN (pipe)	Colour	Reference			Note
135	63-125	White	E13TU05	5	1.200	With removable mosquito mesh
135	63-125	Copper	E13TU0R	5	1.200	With removable mosquito mesh

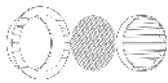

Easy inspection

**Thermo shrinking**

De (mm)	DN (pipe)	Colour	Reference			Note
135	63-125	White	E13TUG5	5	1.200	With removable mosquito mesh
135	63-125	Copper	E13TUGR	5	1.200	With removable mosquito mesh

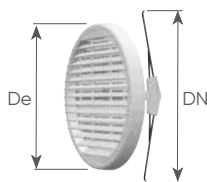
AIR FLOW: 100 cm²**Round push-in vent Ø160 (type 125)****Grille ronde avec ressort de fixation Ø160****Rejilla circular conexión a presión Ø160**

De (mm)	DN (pipe)	Colour	Reference			Note
160	80-140	White	E16TU05	5	600	With removable mosquito mesh
160	80-140	Copper	E16TU0R	5	600	With removable mosquito mesh

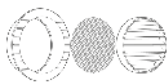

Easy inspection

**Thermo shrinking**

De (mm)	DN (pipe)	Colour	Reference			Note
160	80-140	White	E16TUG5	5	720	With removable mosquito mesh

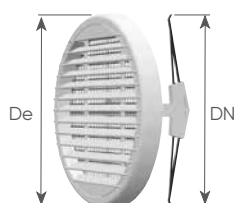
AIR FLOW: 130 cm²

Easy inspection



Round push-in vent Ø186 (type 160)

Grille ronde avec ressort de fixation Ø186
Rejilla circular conexión a presión Ø186

De (mm)	DN (pipe)	Colour	Reference			Note
186	100-160	White	E18TU05	5	600	With removable mosquito mesh
186	100-160	Copper	E18TU0R	5	600	With removable mosquito mesh

Thermo shrinking

De (mm)	DN (pipe)	Colour	Reference			Note
186	100-160	White	E18TUG5	5	720	With removable mosquito mesh

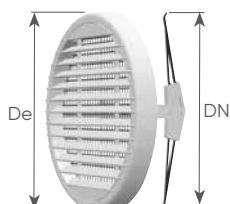
AIR FLOW: 210 cm²

Easy inspection



Round push-in vent Ø230 (type 200)

Grille ronde avec ressort de fixation Ø230
Rejilla circular conexión a presión Ø230

De (mm)	DN (pipe)	Colour	Reference			Note
230	100-200	White	E23TU05	3	288	With removable mosquito mesh

Thermo shrinking

De (mm)	DN (pipe)	Colour	Reference			Note
230	100-200	White	E23TUG5	3	240	With removable mosquito mesh
230	100-200	Copper	E23TUGR	3	240	With removable mosquito mesh

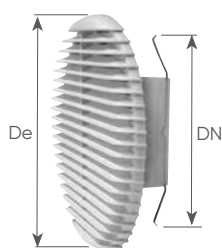
AIR FLOW: 300 cm²

Round push-in vent Ø260 (type 250)

Grille ronde avec ressort de fixation Ø260
Rejilla circular conexión a presión Ø260

De (mm)	DN (pipe)	Colour	Reference			Note
260	160-250	White	E26TU05	2	348	

Built-in air vent Ø32 - 60 (without mosquito mesh)

Grille ronde pour caissons de volet roulant (sans moustiquaire)
Rejilla de ventilacion empotrable (sin mosquitera)

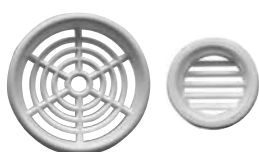

De (mm)	DN (pipe)	Colour	Reference			Note
32	39	White	VAE3205	100	-	

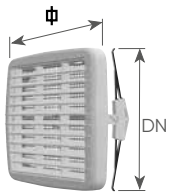
AIR FLOW: 130 cm²

Square push-in vent 175x175

Grille carrée avec ressort de fixation 175x175
Rejilla cuadrada conexión a presión 175x175

φ (mm)	DN (pipe)	Colour	Reference			Note
175	100-160	White	E17QU05	5	600	With removable mosquito mesh

Thermo shrinking

φ (mm)	DN (pipe)	Colour	Reference			Note
175	100-160	White	E17QUG5	5	600	With removable mosquito mesh

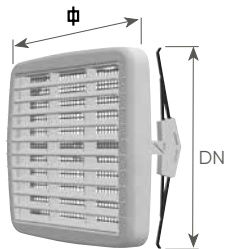
AIR FLOW: 200 cm²

Square push-in vent 210x210

Grille carrée avec ressort de fixation 210x210
Rejilla cuadrada enchufe rápido 210x210

φ (mm)	DN (pipe)	Colour	Reference			Note
210	125-200	White	E21QU05	3	288	With removable mosquito mesh

Thermo shrinking

φ (mm)	DN (pipe)	Colour	Reference			Note
210	125-200	White	E21QUG5	3	288	With removable mosquito mesh

AIR FLOW: 130 cm²

Square surface mounted vent 175x175

Grille carrée à visser 175x175
Rejilla cuadrada montaje en superficie 175x175

φ (mm)	DN (pipe)	Colour	Reference			Note
175	160	White	E18QS05	5	600	With removable mosquito mesh

AIR FLOW: 200 cm²

Square surface mounted vent 210x210

Grille carrée à visser 210x210
Rejilla cuadrada montaje en superficie 210x210

φ (mm)	DN (pipe)	Colour	Reference			Note
210	200	White	E22QS05	3	432	With removable mosquito mesh

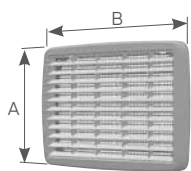

AIR FLOW: 200 cm²

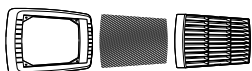

Easy inspection

Rectangular surface mounted vents 175x270
Grille rectangulaire à visser 175x270
Rejilla rectangular montaje en superficie 175x270

AxB (mm)	Colour	Reference			Note
175x270	White	E172705*	2	384	ABS
175x270	Copper	E17270R	2	384	ABS

Ø160



Ø125



*upon request



AIR FLOW: 170 cm²

Rectangular built-in vents
Grille rectangulaire à visser - Rejilla rectangular para atornillar

Dim (mm)	Dim Carving	Colour	Reference			Note
370x123	335x95	White	V371205	6	1800	



AIR FLOW: 280 cm²

Rectangular built-in vents
Grille rectangulaire à visser - Rejilla rectangular para atornillar

Dim (mm)	Dim Carving	Colour	Reference			Note
370 x 223	335 x 185	White	V372205	5	40	

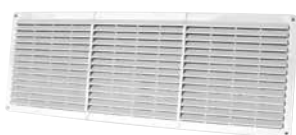

AIR FLOW: 630 cm²

Rectangular built-in vents
Grille rectangulaire à visser - Rejilla rectangular para atornillar

Dim (mm)	Colour	Reference			Note
230x630	White	VGR6305	4	-	

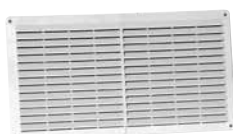

AIR FLOW: 300 cm²

Rectangular built-in vents
Grille rectangulaire à visser - Rejilla rectangular para atornillar

Dim (mm)	Colour	Reference			Note
230x430	White	VGR4305	4	256	

Square grill with adjustable air flow

Grille carrée à fermeture réglable - Rejilla cuadrada con apertura regulable



AxB (mm)	CxD (mm)	Ø (mm)	Colour	Reference			Note
150x150	97x100	-	White	EGQ5005	1	1.360	Surface mounted
190x190	131x131	-	White	EGQ9005*	1	780	Surface mounted

*upon request

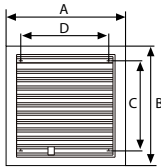
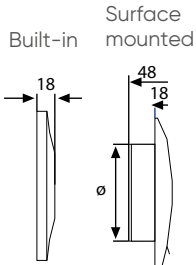

Round built-in grill with mosquito net (copper)

Grille ronde à sceller avec moustiquaire (cuivre)

Rejilla empotrable circular con filtro anti-mosquitos (cobre)

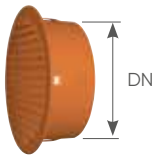

DN (mm)	Free Air	Reference			Note
80	24,5	GTI08RA	24	3.168	
100	70	GTI10RA	1	480	
120	84	GTI12RA	24	480	
140	98	GTI14RA*	24	480	
150	98	GTI15RA*	24	1.080	
160	98	GTI16RA	24	576	
200	140	GTI20RA*	12	240	

*upon request

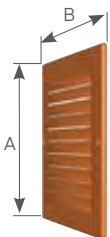

Rectangular and square grill with mosquito net (copper)

Grille carrée à visser avec moustiquaire (cuivre)

Rejilla rectangular y cuadrada con filtro anti-mosquitos (cobre)

AxB (mm)	Free Air	Reference			Note
140x140	70	GRS14RA	1	1.000	
140x250	101,5	GRS25RA	1	1.000	
140x350	150,5	GRS35RA	1	500	
230x230	193	GRS23RA	1	400	

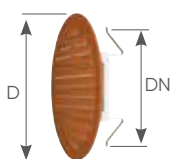

Round push-in grill with mosquito net (copper)



Grille ronde avec ressort de fixation et moustiquaire (cuivre)

Rejilla circular conexión a presión con filtro anti-mosquitos (cobre)

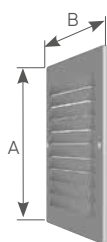
D (mm)	DN Min	Pipe	Free Air	Reference			Note
135	80	125	70	GTM13RA	1	-	
175	125	160	98	GTM17RA	1	500	
230	160	200	140	GTM23RA	20	900	



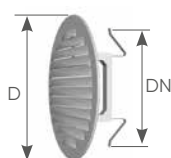

Rectangular and square grill with mosquito net (aluminium)
Grille carrée à visser avec moustiquaire (aluminium)
Rejilla rectangular y cuadrada con filtro anti-mosquitos (aluminio)

AxB (mm)	Free Air	Reference			Note
140x140	70	GRS40AL	1	1000	
140x250	101,5	GRS45AL	25	1000	
140x350	150,5	GRS50AL	25	500	
230x230	193	GRS55AL	1	400	



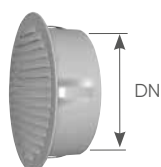

Round push-in grill with mosquito net (aluminium)
Grille ronde avec ressort de fixation et moustiquaire (aluminium)
Rejilla circular enchufe rapido con filtro anti-mosquitos (aluminio)

D (mm)	DN Min	Pipe Max	Free Air	Reference			Note
135	80	125	70	GTM30AL	25	500	
175	125	160	98	GTM35AL	25	500	
230	160	200	140	GTM40AL	25	500	



Round push-in grill with mosquito net (aluminium)
Grille ronde avec ressort de fixation et moustiquaire (aluminium)
Rejilla circular conexión a presión con filtro anti-mosquitos (aluminio)

DN (mm)	Free Air	Reference			Note
80	24,5	GTI30AL	1	960	
100	70	GTI35AL	1	-	
120	84	GTI40AL	1	-	
140	98	GTI45AL	24	480	
150	98	GTI50AL	24	1.080	
160	98	GTI55AL	12	288	
200	140	GTI65AL	12	240	

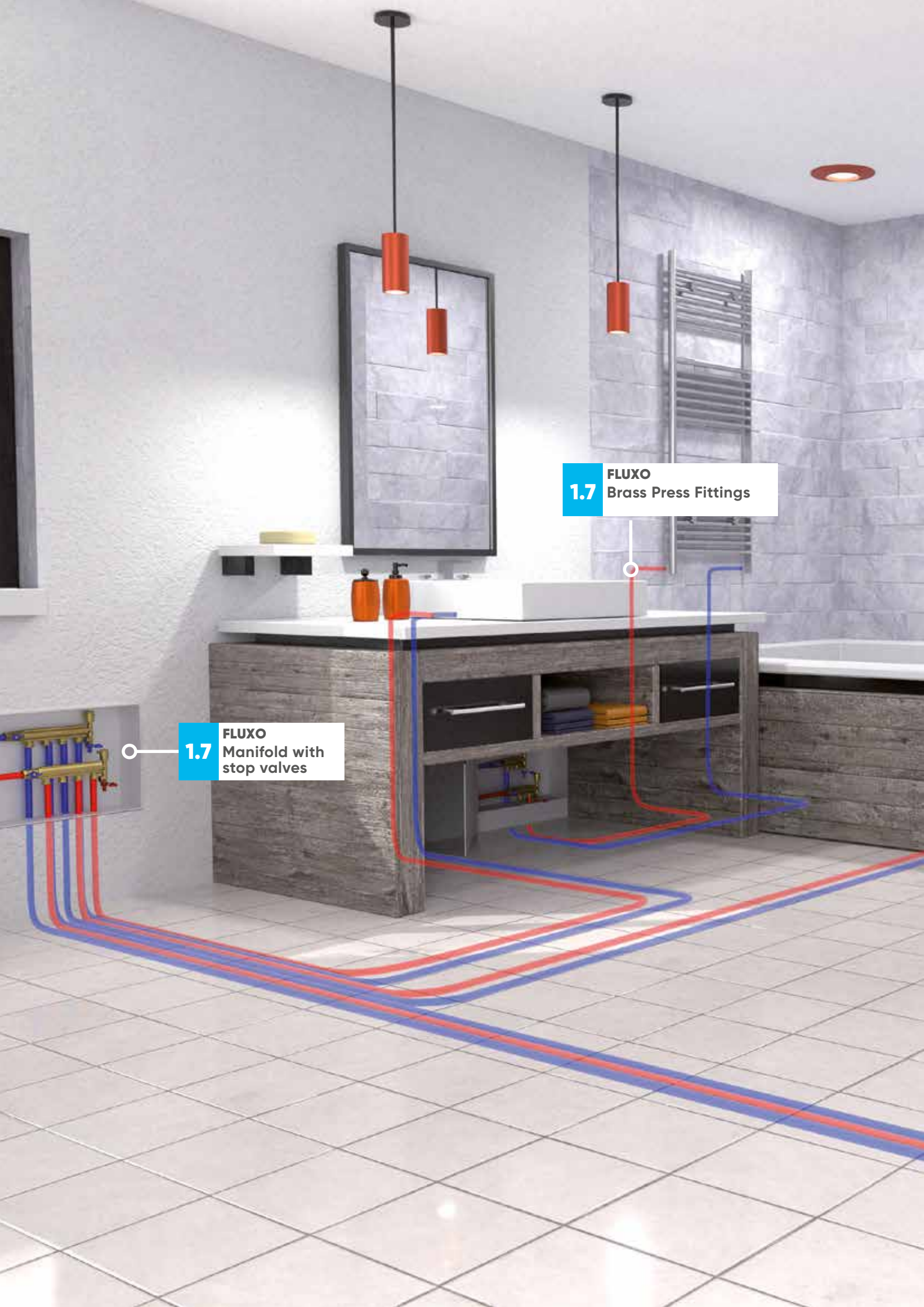

1.7 FLUXO
Brass Press Fittings

1.7 FLUXO
Manifold with
stop valves



1.7 FLUXO
PEX-Al-PEX Multi Layer Pipe

FLUXO[®]



Heating, Cooling, and Water Supply System

1.6 FLUXO



PEX-Al-PEX Multi Layer Pipe
Brass Press Fittings



FLUXO® is a Fully-Compliant System



Heating



Supply



Hot and cold water



Drinking water

FLUXO® Smart System to Save Time



1- Cutting the pipe



2- Chamfering the pipe



3- Placing the fitting



4- Pressing the fitting

Perfect connections in record time: 3 times faster compared to traditional systems

Creating a system using traditional materials and welding techniques requires some time. As professional installer, you know exactly what we are talking about. Thanks to the FLUXO® multilayer system, your systems will be installed three times faster, regardless of the type of application and working procedures. Modern and simple, this system combines the benefits of hi-tech multilayer pipes with specifically-developed brass fittings. With a few operations: cutting the pipe, chamfering, inserting the fitting and pressing, and the connection is finished with the utmost ease and at top speed! With each connection you do, you will save precious minutes. But these minutes will turn into hours if you consider all the sites you work in. In a nutshell, this is the aim of the FLUXO® system: making your job easy and more profitable.

BEAR IN MIND, YOU CAN:

- Improve productivity on the job
- Reduce installation costs
- Avoid delays in delivery times

Compare costs and benefits.

FLUXO® will convince you from all points of view

If you compare the ensured benefits of the FLUXO® system with the costs of traditional installation techniques (labour time for welding, waste, slowness,

etc.) you will definitely notice a significant difference in the cost of the system. All this, without taking into consideration the cost fluctuations of metal (copper) and the irregular supply on construction sites and warehouses.

The time has come, therefore, to choose the FLUXO® multilayer system. The best way to actually see all the benefits of this system is to try it yourself. Ask your local dealer.

TIME

Connection with traditional technique



TIME

Connection with FLUXO® system



Take a Closer Look at FLUXO It Bends to Every Need



TECHNICAL FEATURES

FLUXO® multilayer pipe is easy to work with as it is flexible but, above all, it will firmly maintain the shape you give it. This is due to its composition: a pipe consisting of 5 layers which comes from the union between synthetic materials (PEX) and an inner layer of laser butt-welded aluminium. FLUXO® embraces the features of synthetic materials and metal materials, offering unparalleled benefits:

- **Simple installation** It is flexible, lightweight and free from "elastic memory", the FLUXO® pipe is the best solution for any water-supply system.
- **Absolute hygiene** It is suitable for drinking water and all food fluids, as certified by important external labor "Studi di Pisa".
- **Corrosion resistance** The polyethylene internal and external layers and the fittings provided with a dielectric barrier protect the aluminium against any type of chemical, electromagnetic and natural corrosion.
- **Low load losses** The internal polyethylene surface has a surface finish that can ensure significant reductions in load losses compared to classic metal pipes; furthermore, the absence of lime deposits or other scaling ensures a flow rate that remains constant over time.
- **Oxygen and light barrier** The aluminium layer blocks the passage of oxygen, water vapour and any other gas, therefore avoiding the formation of corrosion in the circuits. Aluminium is also a fully-effective barrier against UV radiation.
- **Reduced thermal expansion** Linear expansion caused by temperature variations is metal pipes. This ensures great stability as regards the size of the pipe and it is therefore subject to limited thermal stress.

Technical benefits

All the benefits of metal:

- rigidity and resistance
- low linear expansion
- versatility
- high professional quality



All the benefits of plastic materials:

- corrosion resistance
- light weight (products and equipment)
- simple and fast installation

It is perfectly compatible with most of the pressing machines on the market.

Create any type of installation variants with safe and suitable fittings: use FLUXO® fittings

Our attention to quality and performance is clear from all FLUXO® system components, especially in the range of fittings. The size precision of FLUXO® fittings is absolute. The positioning of the O-rings on fittings is designed to obtain the maximum adherence between the fitting nipple and the internal layer of the pipe, ensuring long-lasting sealing performance.

Your fittings will therefore be created with extreme precision and safety.

The size of our product range is also another benefit: you can create any type of installation thanks to the variety of FLUXO® fittings.

As regards pipes, the range of fittings is available for diameters between 16 mm and 63 mm. The fittings are made from brass bars of the highest quality, ensuring optimum corrosion-resistant properties.

QUALITY AND RELIABILITY

Thanks to the best technology of composite materials and the continuous improvements, you can benefit from the extreme reliability of the multilayer FLUXO® system. Crosslined polyethylene is abrasion resistant so it means the Fluxo pipes are durable 8 times lower than the plastic pipe and can be compared to.

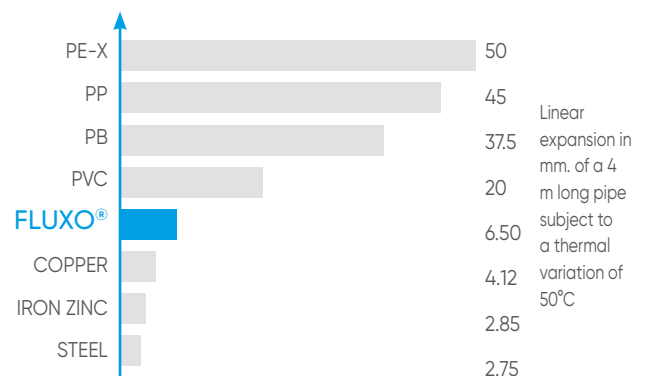

Made in Italy

The multilayer FLUXO® system is made in Italy according to the EN ISO 21003 standard. The EN ISO 21003 is the European standard providing the suitability features for the application of multilayer piping systems for hot and cold water supply inside buildings and for heating purposes.

- **Safety and reliability:** the FLUXO® system is the most advanced and professional solution for hot and cold water supply:
- **Compliance with Standards:** the FLUXO® pipes and fittings are manufactured in full compliance with regulations and prescriptions in terms of quality, hygiene and energy saving.
- **Safety:** the risk of fire on the construction site is practically eliminated, also avoiding unpleasant accidents such as burns on carpets, parquet or walls.
- **Reliability and durability:** the FLUXO® system, in addition to our ten-year warranty, is certified to last longer than 50 years.
- **Soundproofing:** the FLUXO® system significantly absorbs the vibrations and water-hammer effects which piping systems are subject to.

Application fields

Domestic water and heating

The top benefit of FLUXO® is its versatility. Regardless of the size of your construction site or the type of intervention, whether you are working in a single house or a block of flats, you will be able to install hot and cold water supply systems and heating systems with one only system.

Cooling

FLUXO® is also perfect for cooling systems which use cold water, thanks to the dedicated "POLAR" range of pipes which are specifically insulated with a particular high-density sheath characterised by a high thermal insulation coefficient.

Hygiene and drinking water

The system complies with the most important norm requirements in terms of hygiene and potability.

System certifications

The FLUXO® system has been tested and certified by significant certifying bodies such as: KIWA (Netherlands) and KQ (France) valid for the range included in the Avis Technique 14/15-1828 in compliance with the UNI EN ISO 21003 Standard ensuring duration, reliability and safety.



Kiwa certificate
System certification in accordance with the UNI EN ISO 21003 standard for the entire FLUXO range: pipe and press fittings. (Certificate no. K55985/03)



Cstb certification
System certification which states the durability and suitability for the installation of heating and domestic hot and cold water supply systems. Valid for the range included in the Avis Technique 14/13 - 1828.



Health compliance
FLUXO® has the important certification on French health compliance (ACS).

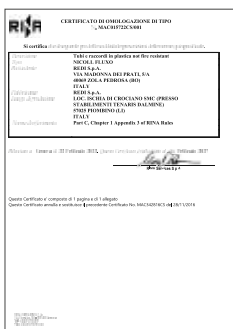

Rina certification
This certificate states the conformity and suitability of the FLUXO® multilayer pipe for use in the naval sector. (Certificate no. MAC015722CS/001)



DNV certification
Products approved by this certificate are accepted for installation on all vessels classed by DNV. (Certificate no. TAK000028U)

Design and installation

Calculation of the load losses

In general, the load losses which may occur on a water circuit can be divided in:

- 1 - Continuous load losses (YC)
- 2 - Localised load losses (YL)

The total load loss (Ytot) is the sum of these two types of losses and is measured in mwc (metres of water column). Therefore: **Ytot = YC + YL**

Continuous load losses (YC) are caused by the friction between the fluid and the internal surface of the pipe.

The multilayer FLUXO® pipe, in this case, shows one of its most significant benefits: its **low internal roughness** leads to very low continuous load losses with respect to traditional metal pipes.

The continuous load losses are calculated using the following formula: **YC = Ycu x pipe L**

Where:

- YC = continuous load losses (mwc)
- Ycu = unitary continuous load losses (mwc/m)
- pipe L = length of the pipe (m)

The Ycu are the continuous load losses per metre of length and can be calculated on the basis of the flow capacity indicated in the table below.

Load loss diagram - ΔL (MBAR/M)

Flow capacity - Water temperature 50°

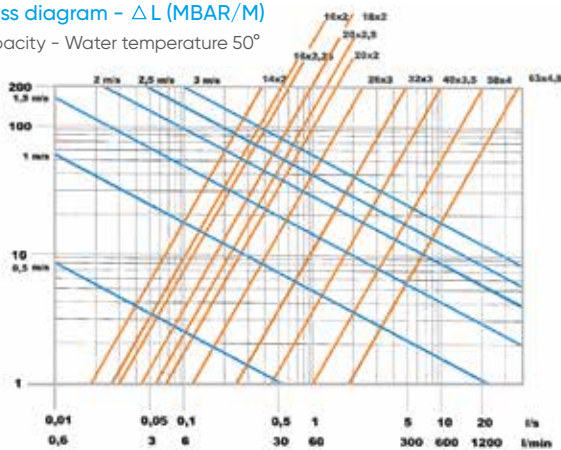

Load losses

Localised load losses (YL) are caused by the geometric variations of the system such as curves, elbows, valves, T-shaped fittings etc... The multilayer FLUXO® pipe offers significant benefits compared to traditional systems: the possibility of creating curves with a very small bending radius, reduces the installation of curves and elbows and therefore the load losses. Compared to PEX pipes, in addition, the presence of the aluminium layer ensures geometric stability and the circularity of the section minimising geometric variations and therefore the load losses. The geometry of the FLUXO® fittings is also designed to improve flow and therefore to reduce these types of load losses.

Localised load losses are calculated using the following formula: **YL = Ycu x eqL**

Where:

- YL = localised load losses (mwc)
- Ycu = unitary continuous load losses (mwc/m)
- eqL = equivalent length of the pipe (m)

The equivalent lengths (eqL) depend on the type of the considered geometric discontinuity and are indicated in the figure below.

Fittings load loss

Discontinuity	Ø 14	Ø 16	Ø 18	Ø 20	Ø 26	Ø 32	Ø 40	Ø 50	Ø 63
Curve	0.7	0.6	0.55	0.5	0.4	0.3	0.3	0.2	0.2
Elbow Angle 45°	1.5	1.4	1.2	1.1	1.0	0.8	0.7	0.6	0.6
T	1.3	1.2	0.9	0.6	0.5	0.3	0.2	0.1	0.1
T	1.6	1.5	1.4	1.3	1.2	1.0	0.9	0.8	0.8
T	1.7	1.6	1.5	1.4	1.3	1.1	1.0	0.9	0.9
T	1.7	1.6	1.5	1.4	1.3	1.1	1.0	0.9	0.9
Straight fitting	1.0	0.9	0.7	0.5	0.4	0.3	0.2	0.1	0.1
Fittings for taps	1.4	1.3	1.2	1.1	/	/	/	/	/

Expansion calculation

The FLUXO® pipe has a thermal expansion similar to that of metal piping, thanks to the aluminium layer and to the adhesive which imposes the metal layer level of expansion on the PE-X layers. The table below shows the comparison between the thermal expansion coefficients of our pipe and that of other materials. The calculation formula for the thermal expansion of the pipe is the following: **L1 = α x L2 x T**

Where:

- L1 = Pipe expansion in mm
- L2 = Length of the pipe in m
- α = Expansion coefficient of the material in mm/m°K
- T = Difference between the service temperature and the temperature at the time of installation, expressed in °C

You can also calculate the pipe expansion by using the diagram on the side. By taking into consideration the horizontal axis which indicates the difference between the service temperature and that calculated at the time of installation, and intersecting the line on the diagram, you can read the expansion value (in mm) per metre of pipe on the vertical axis. To calculate the effective expansion, the latter value must be multiplied by the length of the pipe (expressed in m).

Thermal expansion coefficient of different materials

Type of piping	Expan. Coeff. α [mm/(m°k)]
FLUXO®	0.026
Galvanised steel	0.012
Stainless steel	0.017
Copper	0.017
Plastic material (PE-X PEHD PPRC)	0.19 - 0.20

Design recommendations

In order to maintain the expected performances and durability of this product range but, above all, to achieve a complete warranty coverage of the system, we recommend that you strictly follow the system design, installation and commissioning standards in order to make sure you carry out your work in a fully-professional manner.

Calculation of the length of the expansion bend

The length of the expansion bend can be deduced from the diagram below, or it can be calculated using the following formula: $b = K \times (D \times L)^{1/2}$

Where:

b = Bend length (in mm)

D = External diameter of the multilayer pipe (in mm)

L = Pipe expansion (calculated as shown above)

K = material constant (for the FLUXO® pipe = 33)

Example:

Calculation of an expansion bend

Calculation of the length of the expansion bend of a multilayer Fluxo pipe with $\varnothing 26$, 8 m long subject to a temperature variation of $T = 60^\circ\text{C}$

$$L1 = \alpha \times L2 \times T =$$

$$0.026 \times 8 \times 60 = 12.5 \text{ mm}$$

$$b = 33 \times (26 \times 12.5)^{1/2} = 595 \text{ mm}$$

Thermal expansion diagram

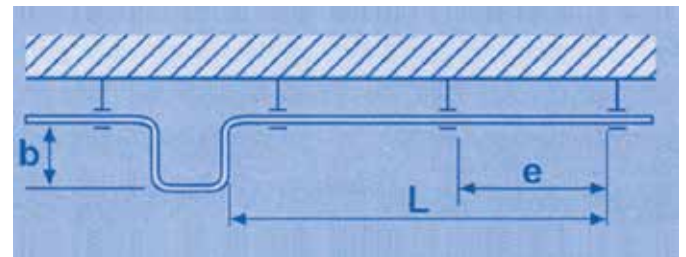
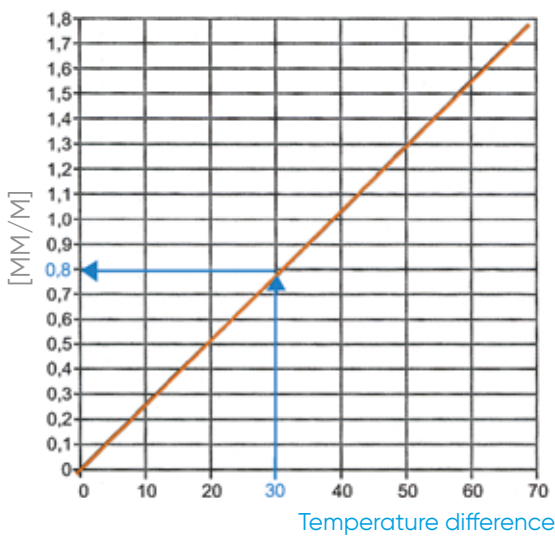

Expansion length ΔL (mm)

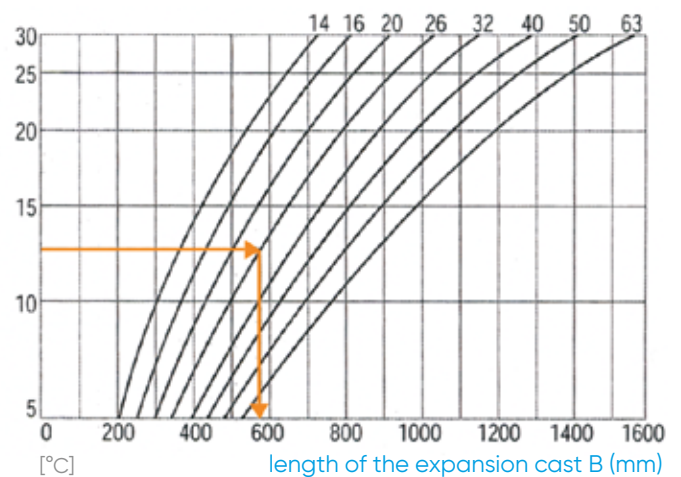

Expansion compensation

Even if the multilayer pipe has low expansion properties, heating and cooling can certainly induce the pipe to expand and contract. A compensation technique for free piping inside shafts, entails creating omega-shaped bends in the straight sections. If the piping is constrained or inside a wall, you can solve the problem by insulating the pipe.

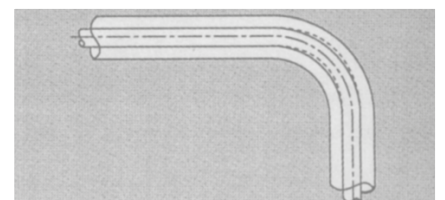
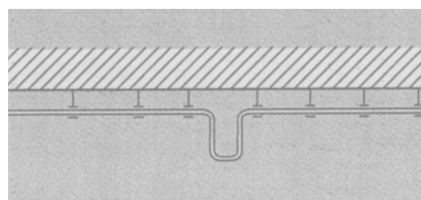
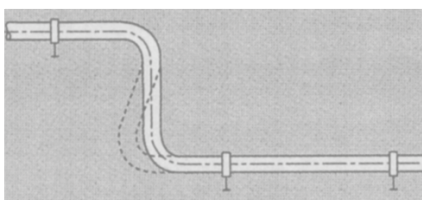

Pipe bending

One of the most significant benefits of the FLUXO® system is the ease with which it can be bent. This important result was only possible thanks to laser technology which ensures highly-resistant welds even with modest thicknesses. In this way we can also ensure an easy bending and geometric stability, in addition to the significant mechanical features of the pipe.

The methods of pipe bending are:

- manual bending
- bending using pipe-bending clamps

The table below shows the minimum obtainable values of bending radii.

External diameter (mm)	Ø14	Ø16	Ø18	Ø20	Ø26	Ø32	Ø40	Ø50	Ø63
Manual bending radius (mm)	70	80	90	100	110	160	550	700	---
Bending radius with bending clamp (mm)	35	45	55	60	95	125	180	210	315

Manual bending

For pipes with a modest diameter and for wide bending radii, manual bending is the fastest and most effective method: the installer must check that the pipe shows no signs of crushing signs on the surface which may be caused by improper bending techniques.

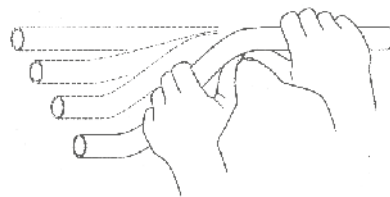

Bending using bending clamps

For smaller bending radii and/or for pipes with a larger diameter, we recommend that you use a bending clamp as shown below.



Phase 1 - Mark the middle of the bending curve.



Phase 2 - Place the pipe inside the bending clamp.

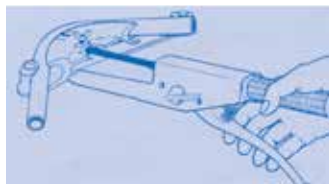

Phase 3 - Use the lever of the clamp until you reach the desired bending angle.



Phase 4 - Loosen the clamp to release the pipe.



Cutting and calibration

1- Cutting the pipe

Cut the pipe perpendicularly to its axis.



2- Inserting the fitting

Insert the fitting in the pipe until it reaches its stop (the O-rings must not be lubricated).



3- Calibrating the pipe

Calibrate and deburr the pipe, making sure you fully remove any plastic shavings.

Press Fittings Installation

Joints with press fittings

For mechanical connections with press fittings, after cutting the pipe perpendicularly to the pipe axis, and after calibration and deburring, insert the pipe into the fitting until it reaches its stop which can be accessible for inspection thanks to the openings and proceed with the pressing of the stainless steel sleeve by using the special tool as shown below.

Preparing the pressing machine

Note: use the appropriate clamp on the base for each size of fitting. Check that these measurements correspond with every application. Preparing the tool: remove the safety pin; insert the jaw; insert the safety pin fully.



1- Remove the safety pin



2- Insert the jaw



3- Insert the safety pin completely



Pressing the fitting

4- Positioning

Warning: place the fitting in the jaw correctly; the seal ring is provided with a design feature which "obliges" this positioning.



5- Pressing

Press the lever until the pressing clamp stops automatically.



6- Opening

Opening the jaw.

Rules for correct installation



Below you will find a set of instructions for the installation of the FLUXO® system to ensure its perfect operation and long lasting performance.

Coupling the fittings

The coupling of fittings in the FLUXO® system, male or female, with fittings of other brands and/or systems, complying with the UNI EN 10226 standard, does not require the use of additional sealing materials such as teflon, hemp, etc. The "construction" of the thread ensures the sealing of the coupling.

Pressing the fittings

The pressing must be carried out with the system completely installed in all its parts and without unnecessary stress which may compromise its correct operation over time.

Bending the pipes

To bend the pipes correctly, without creating dangerous stresses, you must measure and mark the pipe accurately and bend it manually or using bending clamps. Pressing must only be done after the pipe has been correctly installed, as shown in the figures below.

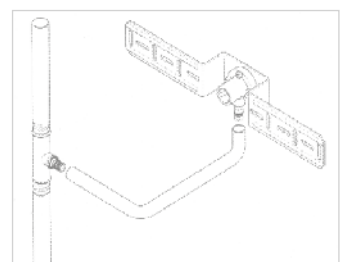
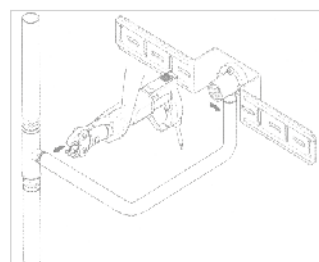
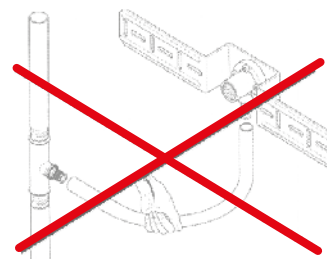

Testing Protocol

Installing "T" shaped fittings

To install "T" shaped fittings, install the pipe, secure it and then press the fittings as shown in the figure on the side.

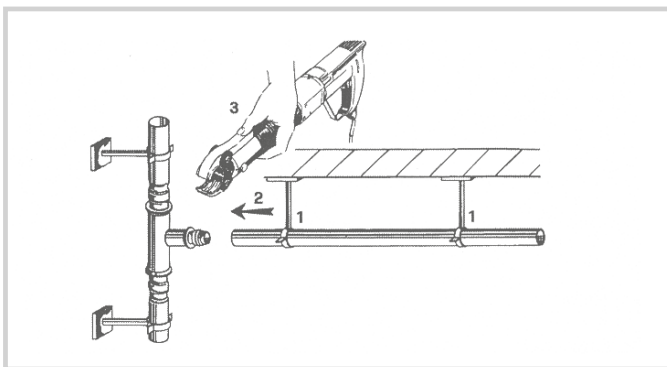
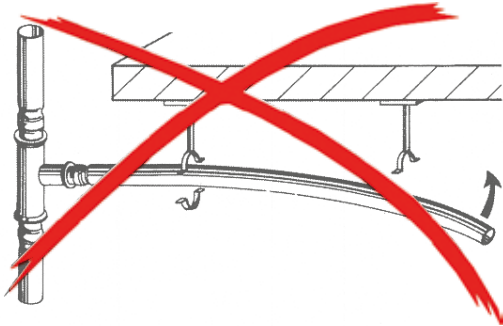

Securing the pipes

Pipes are to be secured using soundproof collars. If the collars are not soundproof, the pipes must be secured on the external insulation of the pipes.

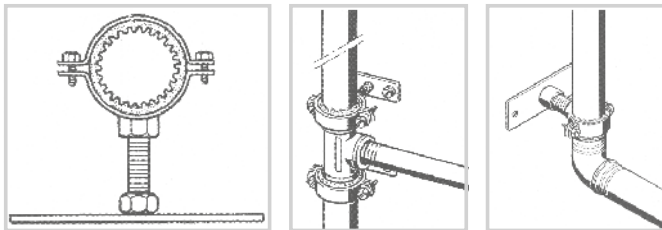

Distance between securing points

Correct positioning of the securing collars ensures correct pipe stability, without creating dangerous stress. The distances between the securing collars, according to the diameter of the pipes, are listed below. Pipes installed horizontally must be secured every 75 cm maximum. A securing collar must be installed 25 cm before and after each curve.

Diameter	Distance L
14 - 16	M
18 - 20	1
26	1.2
32	1.5

Testing the system

WARNING

Every system must be tested in accordance with the reference standard before concealing the system into the wall. Failing to perform this test will relieve the company of any liability arising from possible accidents, involving injury to persons or damage to property.

Civil liability regarding systems always lies with the installation company which must safeguard its work and perform tests on the systems as a standard requirement for the completion of the job.

The following is the correct procedure for testing in accordance with the DIN 1988 standards.

Pre-test. Duration 30 min.

Fill the system with fluid and bleed any air out of it via the top parts of the pipe system; then, apply a pressure of 15 bar for 15 minutes and check for any leaks in the mechanical fittings. The maximum pressure drop within the 30 minutes of the test is 0.3 bar.

Test. Duration 2 hours

After the pre-test and after having restored the pressure, proceed with the definitive test which requires longer verification times.

Apply once again a pressure of 15 bar to the system for a minimum of two hours within which the maximum pressure drops must not exceed 0.3 bar. After the positive outcome of the test you can conceal the system inside the wall.

Testing protocol

We recommend you always draft a report of the test stating its positive outcome. For such tests we recommend you use a pump fitted with a pressure gauge with 0.1 bar precision and connect it to the lowest point of the system to be tested. The concealing of the system must always be performed with the circuits under fixed service pressure.

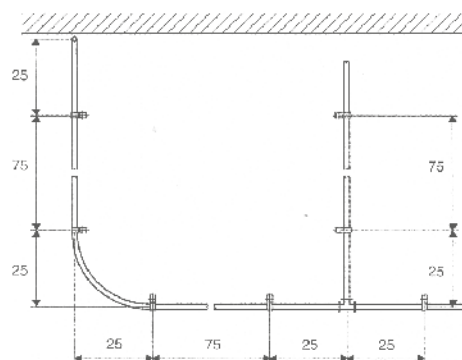

Multilayer FLUXO® Pipe

The FLUXO® pipe is produced through the combination of an aluminium alloy and high quality crosslinked polyethylene. The aluminium core provides a lower thermal linear expansion compared to other plastic materials that are generally used in heating and domestic plumbing systems. The external layer protects the aluminium from potential corrosion risks providing mechanical, electrical and chemical protection. Additionally, the internal layer is fully suited to be in contact with water, as certified by external laboratories. The multilayer FLUXO® pipe is produced and certified according to the UNI EN ISO 21003 standard.



Inner aluminium core:

The butt-welded aluminium using 5 micron laser technology, can withstand the highest pressures. It creates an 100% impenetrable oxygen barrier and a UV-protection barrier, significantly preventing the formation of algae inside the system. Elastic memory makes the installation simple and reduces the use of pipe fittings.

Internal and external layer in cross-linked polyethylene (PE-Xb)

Exceptional temperature resistance Thanks to cross-linking, PEX is the most long-lasting and resistant plastic material to hot and cold water cycles under pressure. This makes the FLUXO® pipe perfect for the installation of heating and domestic water-supply systems.

Anti-corrosion The internal and external PEX layers ensure total protection of the aluminium layer inside.

Soundproofing The PEX layers absorb vibrations and sounds produced by water flows and water-hammer effects.

Drinking water The PEX layer is suitable for drinking water and food fluids.

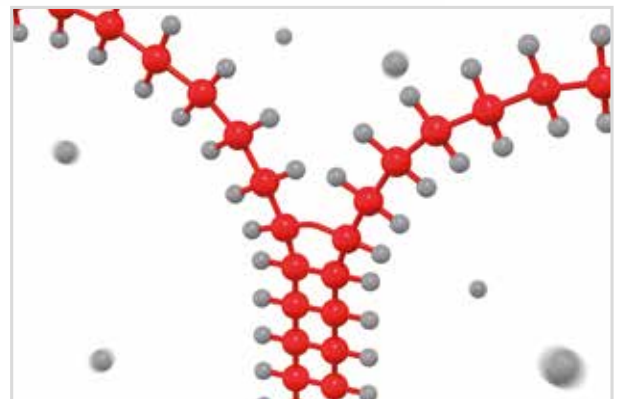

Cross-linked polyethylene (PE-Xb). Permanent link between the molecular chains thanks to crosslinking.

Insulation sheath



The multilayer Fluxo pipe is covered with a high-performance insulating sheath with the following **certified** features:

- White exterior
- Polyethylene closed-cell foam material (recyclable)
- Class 1 fire-resistance classification
- Density 35kg/m³
- Service temperature range -45°C + 100°C
- Permeability coefficient >6000
- Thermal conductivity coefficient at 40°C 0.039 W/(m*K)
- Non-toxic
- CFC (Freon) CFC-Free

Naked pipe in coils, packed in boxes

Tube multicouche nu en couronne, emballage en boîte de carton
Tubería multicapa en rollo, embalaje en caja de cartón





Ø (mm)	Thickness pipe (mm)	Reference	 (mt)	 (mt)	Coil (m)	Note
16	2.0	M010566	100	2.800	100	
20	2.0	M011535	100	1.800	100	
26	3.0	M012626	50	900	50	
32	3.0	M013208	50	450	50	

Insulated pipe in coils, packed in boxes

Tube multicouche pré-isolé en couronne, emballage en boîte de carton - Tubería multicapa preaislado en rollo, embalaje en caja de cartón





Ø (mm)	Thickness pipe (mm)	Insulation thickness (mm)	Reference	 (mt)	 (mt)	Coil (m)	Note
16	2.0	6	M040537	50	900	50	
20	2.0	6	M041528	50	900	50	
20	2.0	10	M041524	50	500	50	
26	3.0	10	M042617	50	500	50	
32	3.0	10	M043208	25	225	25	

"Polar" insulated pipe for cooling systems, packed in boxes (for systems with fancoil units, heat pumps)

Tube multicouche pré-isolé "Polar" en couronne, emballage en boîte de carton - Tubería multicapa preaislado "Polar" en rollo, embalaje en caja de cartón





Ø (mm)	Thickness pipe (mm)	Insulation thickness (mm)	Reference	 (mt)	 (mt)	Coil (m)	Note
16	2.0	10	MT116PT	50	900	50	
20	2.0	10	MT120PT	50	900	50	
26	3.0	10	MT126PT	50	900	50	
32	3.0	10	MT132PT	25	225	25	

With special sheath

Straight pipes

Tube multicouche nu en barre - Tubería multicapa en barra





Ø (mm)	Thickness pipe (mm)	Reference	 (mt)	 (mt)	mt	Pack (no. of bars)	Note
16	2.0	M020511	100	4.800	4	25	
20	2.0	M021514	64	3.072	4	16	
26	3.0	M022612	40	1.920	4	10	
32	3.0	M023208	28	1.344	4	7	
40	3.5	M023307	25	500	5	5	
50	4.0	M023407	25	500	5	5	
63	4.5	M023507	15	300	5	3	
75	5.0	M023602	10	200	5	2	



Naked pipe in coils, toroidal packaging

Tube multicouche nu en couronne



Tubería multicapa en rollo

Ø (mm)	Thickness pipe (mm)	Reference	 (mt)	 (mt)	Coil (m)	Note
16	2.0	M010520	100	2.000	100	
20	2.0	M011510	100	1.300	100	
26	3.0	M012610	50	600	50	
32	3.0	M013220	50	400	50	



White Pipe System in coils, toroidal packaging



Tube multicouche "System" pré-isolé en couronne, couleur blanche - Tubería multicapa "System" en rollo, color blanco

Ø (mm)	Thickness pipe (mm)	Insulation thickness (mm)	Reference	 (mt)	 (mt)	Coil (m)	Note
16	2.0	6	M040511	50	700	50	
20	2.0	6	M041513	50	700	50	
20	2.0	10	M041515	50	500	50	
26	3.0	10	M042605	50	400	50	
32	3.0	10	M043206	25	225	25	



Blue Pipe System in coils, toroidal packaging



Tube multicouche "System" pré-isolé en couronne, couleur bleue - Tubería multicapa "System" en rollo, color azul

Ø (mm)	Thickness pipe (mm)	Insulation thickness (mm)	Reference	 (mt)	 (mt)	Coil (m)	Note
16	2.0	6	M040505	50	700	50	
20	2.0	6	M041505	50	700	50	
26	3.0	10	M042604	50	400	50	
32	3.0	10	M043209	25	225	25	



Red Pipe System in coils, toroidal packaging

Tube multicouche "System" pré-isolé en couronne, couleur rouge - Tubería multicapa "System" en rollo, color rojo



Ø (mm)	Thickness pipe (mm)	Insulation thickness (mm)	Reference	 (mt)	 (mt)	Coil (m)	Note
16	2.0	6	M040516	50	700	50	
20	2.0	6	M041504	50	700	50	
26	3.0	10	M042603	50	400	50	
32	3.0	10	M043207	25	225	25	



Pipe "Tech" in coils, toroidal packaging

Tube multicouche "Tech" en couronne



Tubería multicapa "Tech" en rollo

Ø (mm)	Thickness pipe (mm)	Insulation thickness (mm)	Reference	 (mt)	 (mt)	Coil (m)	Note
16	2.0	13	M040514	50	400	50	
20	2.0	13	M041534	50	400	50	
26	3.0	13	M042600	50	350	50	
32	3.0	13	M043221	25	225	25	



Pipe corrugated blue in coils, packed in boxes



Tube multicouche pré-fourreauté bleu en couronne, emballage en boîte de carton - Tubería multicapa corrugada color azul, embalaje en caja de cartón

Ø (mm)	Thickness pipe (mm)	Reference	 (mt)	 (mt)	Coil (m)	Note
16	2.0	M060534	50	900	50	Corrugated blue
16	2.0	M060508	100	1.000	100	Corrugated blue
20	2.0	M061515	50	900	50	Corrugated blue



Pipe corrugated red in coils, packed in boxes

Tube multicouche pré-fourreauté rouge, emballage en boîte de carton - Tubería multicapa corrugada color rojo, embalaje en caja de cartón

Ø (mm)	Thickness pipe (mm)	Reference	 (mt)	 (mt)	Coil (m)	Note)
16	2.0	M060535	50	900	50	Corrugated red
16	2.0	M060509	100	1.000	100	Corrugated red
20	2.0	M061516	50	900	50	Corrugated red

Press Fittings

The press fittings of the FLUXO® range are designed to rapidly perform any type of installation with maximum flexibility and safety: the FLUXO® fittings are made in high-quality brass are in accordance with the ACS French health compliance standard.



1

Dielectric ring: avoids any contact with the aluminium of the pipe so as to eliminate any electrical conductivity risks

2

Inspection opening to check the pipe insertion

3

Double O-ring in EPDM perox

4

Stainless steel large sleeves. Stainless steel 304 used for the sleeves ensures high-resistance to corrosion and optimum pipe pressing.

The TH pressing system

We have chosen to use the TH pressing profile as it is the most widely used in the market. Furthermore, the TH profile gives more stability to the fitting inside the pressing jaws.

The pressing system for fittings between $\varnothing 14$ and $\varnothing 63$ is made using a TH version clamp which deforms the sleeve in solubilised stainless steel (AISI 304) creating the connection between the pipe and the fitting.

► *Fittings with diameters of 40 - 50 - 63 - 75 mm have a plastic sleeve-holder.*

Safety and health compliance

The brass alloys used to produce FLUXO® fittings, indicated as CW614N according to **UNI EN 12164** (for bar) and CW617N according to **UNI EN 12165** (for heat pressing), in terms of hygiene and drinking water, comply with the requirements provided **by the Italian Ministerial Decree 174 of 2004**.

Equipment:

If you already have a Rems, Rothenberger, Virax, Klauke or Novopress pressing machine and TH profile jaws, you can use the FLUXO® system with your equipment

If you have a pressing machine of one of the brands listed above but you do not have the TH profile jaws, all you need to do is replace the latter for use with FLUXO® fittings.

Bear in mind

- Simple installation
- Corrosion resistance
- System installation speed
- Health compliance certification
- Wide range to cover any installation requirement





Type A



Type B

Adapter male thread

Manchons à sertir, à visser mâles fixes

Racor prensado macho

Type	Ø Fitting	Ø Thread	Reference			Note
A	16	1/2"	MM1160P	10	6.000	
A	16	3/4"	MC1161P	10	7.290	
A	20	1/2"	MM1200P	10	6.000	
A	20	3/4"	MM1210P	10	7.000	
A	26	3/4"	MM1260P	10	4.860	
A	26	1"	MM1270P	10	4.860	
A	32	1"	MM1320P	5	3.645	
B	40	1" 1/4	MM1400P	5	1.200	▶ Plastic sleeve-holder
B	50	1" 1/2	MM1510P	2	972	▶ Plastic sleeve-holder
B	63	2"	MM1630P	2	972	▶ Plastic sleeve-holder
B	75	2" 1/2	MM1730P	1	8	▶ Plastic sleeve-holder



Type A



Type B

Adapter female thread

Manchons à sertir, à visser femelles fixes

Racor prensado hembra

Type	Ø Fitting	Ø Thread	Reference			Note
A	16	1/2"	MM4160P	10	6.000	
A	16	3/4"	MC1162P	10	8.000	
A	20	1/2"	MM4200P	10	6.000	
A	20	3/4"	MM4210P	10	7.290	
A	26	3/4"	MM4260P	10	4.860	
A	26	1"	MM4270P	10	800	
A	32	1"	MM4320P	5	3.645	
B	40	1" 1/4	MM4400P	5	810	▶ Plastic sleeve-holder
B	50	1" 1/2	MM4510P	2	1.458	▶ Plastic sleeve-holder
B	63	2"	MM4630P	2	240	▶ Plastic sleeve-holder
B	75	2" 1/2	MM4730P	1	8	▶ Plastic sleeve-holder

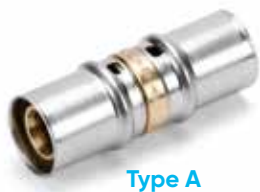



Type A



Type B



Straight coupler

Manchons à sertir égaux - Manguito prensado

Type	Ø Fitting	Reference			Note
A	16 x 16	MM2160P	10	6.000	
A	20 x 20	MM2200P	10	7.290	
A	26 x 26	MM2260P	10	4.860	
A	32 x 32	MM2320P	5	3.645	
B	40 x 40	MM2400P	5	810	▶ Plastic sleeve-holder
B	50 x 50	MM2500P	2	972	▶ Plastic sleeve-holder
B	63 x 63	MM2630P	2	128	▶ Plastic sleeve-holder
B	75 x 75	MM2750P	1	8	▶ Plastic sleeve-holder

Reducing coupling

Manchons à sertir réduits- Manguito reducido prensado

Type	Ø Fitting	Reference			Note
A	20 x 16	MM3210P	10	6.000	
A	26 x 16	MM3240P	10	4.860	
A	26 x 20	MM3260P	10	4.860	
A	32 x 20	MM3310P	5	800	
A	32 x 26	MM3320P	5	3.645	
B	40 x 26	MM3390P	5	400	▶ Plastic sleeve-holder
B	40 x 32	MM3400P	5	1.200	▶ Plastic sleeve-holder
B	50 x 26	MM3480P	2	240	▶ Plastic sleeve-holder
B	50 x 32	MM3490P	2	-	▶ Plastic sleeve-holder
B	50 x 40	MM3500P	2	972	▶ Plastic sleeve-holder
B	63 x 40	MM3620P	2	-	▶ Plastic sleeve-holder
B	63 x 50	MM3630P	2	972	▶ Plastic sleeve-holder
A	75 x 40	MM3640P	1	8	▶ Plastic sleeve-holder
A	75 x 50	MM3641P	1	-	▶ Plastic sleeve-holder
A	75 x 63	MM3642P	1	-	▶ Plastic sleeve-holder



Type A



Type B

Equal tee 90°

Tés à sertir égaux 90° - Te prensado 90°

Type	ØA x ØB x ØC Fitting	Reference			Note
A	16 x 16 x 16	MD1160P	10	4.860	
A	20 x 20 x 20	MD1200P	10	2.400	
A	26 x 26 x 26	MD1260P	10	1.620	
A	32 x 32 x 32	MD1320P	5	810	
B	40 x 40 x 40	MD1400P	5	-	▶ Plastic sleeve-holder
B	50 x 50 x 50	MD1500P	2	16	▶ Plastic sleeve-holder
B	63 x 63 x 63	MD1630P	2	162	▶ Plastic sleeve-holder
B	75 x 75 x 75	MM1631P	1	1	▶ Plastic sleeve-holder

Reducing tee 90°

Tés à sertir réduits 90° - Te reducida prensado 90°

Type	ØA x ØB x ØC Fitting	Reference			Note
A	20 x 16 x 20	MD3150P	10	2.400	
A	20 x 26 x 20	MD2200P	10	1.620	
A	26 x 16 x 26	MD3230P	10	1.620	
A	26 x 20 x 26	MD3270P	10	1.620	
A	26 x 32 x 26	MD2310P	5	400	
A	32 x 16 x 32	MD3320P	5	400	
A	32 x 20 x 32	MD3350P	5	810	
A	32 x 26 x 32	MD3370P	5	810	
A	32 x 40 x 32	MD1261P	5	320	
B	40 x 20 x 40	MD1262P	5	-	▶ Plastic sleeve-holder
B	40 x 26 x 40	MD3400P	5	360	▶ Plastic sleeve-holder
B	40 x 32 x 40	MD3410P	5	320	▶ Plastic sleeve-holder
B	50 x 26 x 50	MD3420P	2	16	▶ Plastic sleeve-holder
B	50 x 32 x 50	MD3430P	2	16	▶ Plastic sleeve-holder
B	50 x 40 x 50	MD3440P	2	128	▶ Plastic sleeve-holder
B	63 x 26 x 63	MD3450P	2	128	▶ Plastic sleeve-holder
B	63 x 32 x 63	MD3460P	2	128	▶ Plastic sleeve-holder
B	63 x 40 x 63	MD3470P	2	-	▶ Plastic sleeve-holder
B	63 x 50 x 63	MD3480P	2	-	▶ Plastic sleeve-holder
B	75 x 50 x 75	MM3481P	1	162	▶ Plastic sleeve-holder
B	75 x 63 x 75	MM3482P	1	8	▶ Plastic sleeve-holder

Unequal Reducing tee 90°

Tés à sertir réduits double 90° - Te reducida prensado 90°

Type	ØA x ØB x ØC Fitting	Reference			Note
A	16 x 20 x 16	MD2121P	10	1.200	
A	20 x 16 x 16	MD2140P	10	4.860	
A	20 x 20 x 16	MD2180P	10	2.400	
A	26 x 26 x 16	MD2280P	10	800	
A	26 x 16 x 20	MD2220P	10	1.620	
A	26 x 20 x 16	MD2250P	10	800	
A	26 x 26 x 20	MD2300P	10	800	
A	26 x 20 x 20	MD2122P	10	800	
A	32 x 20 x 26	MD2340P	5	-	
A	32 x 32 x 26	MD2380P	5	-	
A	32 x 26 x 26	MD2360P	5	810	
B	40 x 32 x 32	MD2124P	5	-	▶ Plastic sleeve-holder

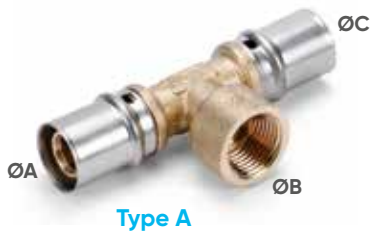

Type A



Type B

Tee 90° female thread

Tés à sertir, femelles à visser 90° - Te rosca hembra 90°

Type	$\varnothing A \times \varnothing B \times \varnothing C$ Fitting	Reference			Note
A	16 x 1/2" x 16	MD5160P	10	4.860	
A	20 x 1/2" x 20	MD5200P	10	2.400	
A	20 x 3/4" x 20	MD5210P	10	800	
A	26 x 3/4" x 26	MD5260P	10	1.620	
A	26 x 1" x 26	MD5142P	10	800	
A	32 x 1" x 32	MD5320P	5	810	
B	40 x 1" x 40	MD5143P	5	320	▶ Plastic sleeve-holder
B	40 x 1 1/4 x 40	MD5400P	5	360	▶ Plastic sleeve-holder
B	50 x 1 1/2 x 50	MD5500P	2	324	▶ Plastic sleeve-holder
B	50 x 3/4" x 50	MD5144P	2	128	▶ Plastic sleeve-holder
B	50 x 1" x 50	MD5145P	15	120	▶ Plastic sleeve-holder
B	63 x 1" x 63	MD5630P	2	128	▶ Plastic sleeve-holder
B	63 x 2" x 63	MD5640P	2	128	▶ Plastic sleeve-holder

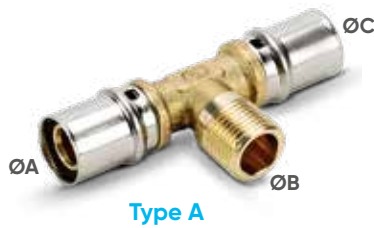

Type A

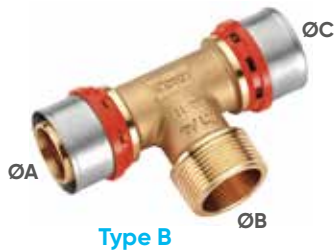

Type B

Tee 90° male thread

Tés à sertir, mâles à visser 90° - Te rosca macho 90°

Type	$\varnothing A \times \varnothing B \times \varnothing C$ Fitting	Reference			Note
A	16 x 1/2" x 16	MD4160P	10	4.860	
A	20 x 1/2" x 20	MD4200P	10	-	
A	20 x 3/4" x 20	MD4210P	10	-	
A	26 x 3/4" x 26	MD4260P	10	800	
A	26 x 1" x 26	MD4161P	10	800	
A	32 x 1" x 32	MD4320P	5	-	
B	40 x 1 1/4" x 40	MD4400P	5	-	▶ Plastic sleeve-holder
B	50 x 1 1/2" x 50	MD4500P	2	-	▶ Plastic sleeve-holder
B	63 x 2" x 63	MD4630P	2	128	▶ Plastic sleeve-holder

Elbow female thread

Coudes à sertir, femelles à visser - Codo rosca hembra



Type A

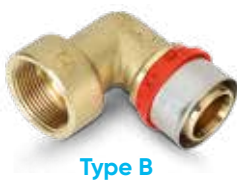

Type B

Type	\varnothing Fitting	\varnothing Thread	Reference			Note
A	16	1/2"	MC3160P	10	7.290	
A	16	3/4"	MC3131P	10	1.600	
A	20	1/2"	MC3200P	10	7.290	
A	20	3/4"	MC3210P	10	4.860	
A	26	3/4"	MC3260P	10	2.400	
A	26	1"	MC3133P	10	800	
A	32	1"	MC3320P	5	2.430	
B	40	1" 1/4	MC3400P	5	320	▶ Plastic sleeve-holder
B	50	1" 1/2	MC3510P	2	480	▶ Plastic sleeve-holder
B	63	2"	MC3630P	2	128	▶ Plastic sleeve-holder

Elbow male thread

Coudes à sertir, mâles à visser - Codo rosca macho



Type	Ø Fitting	Ø Thread	Reference			Note
A	16	1/2"	MC2160P	10	7.290	
A	16	3/4"	MC2201P	10	1.600	
A	20	1/2"	MC2200P	10	7.290	
A	20	3/4"	MC2210P	10	4.860	
A	26	3/4"	MC2260P	10	2.400	
A	26	1"	MC2203P	10	800	
A	32	1"	MC2320P	5	2.430	
B	40	1" 1/4	MC2400P	5	-	▶ Plastic sleeve-holder
B	50	1" 1/2	MC2510P	2	-	▶ Plastic sleeve-holder
B	63	2"	MC2630P	2	128	▶ Plastic sleeve-holder

Elbow 90°

Coudes à sertir à 90° - Codo 90°



Type	Ø Fitting	Reference			Note
A	16 x 16	MC1160P	10	7.290	
A	20 x 20	MC1200P	10	4.860	
A	26 x 26	MC1260P	10	2.400	
A	32 x 32	MC1320P	5	2.430	
B	40 x 40	MC1400P	5	360	▶ Plastic sleeve-holder
B	50 x 50	MC1500P	2	324	▶ Plastic sleeve-holder
B	63 x 63	MC1630P	2	324	▶ Plastic sleeve-holder
A	75 x 75	MC1650P	1	8	▶ Plastic sleeve-holder

Elbow 45°

Coudes à sertir à 45° - Codo 45°



Size	Reference			Note
40 x 40	MG1140P	5	-	
50 x 50	MG1160P	2	-	
63 x 63	MG1200P	2	324	
75 x 75	MG1210P	1	32	



Wall-threaded-bracket female elbow

Coudes appliques à sertir, femelles à visser

Codo fijación rosca hembra

Ø Fitting	Ø Thread	Reference	Length (mm)			Note
16	1/2"	MF3160P	53	10	2.400	
20	1/2"	MF3200P	53	10	2.400	



Long Wall-Threaded-Bracket Female Elbow

Coudes appliques à sertir, femelle à visser hauteur

Codo fijación largo rosca hembra

Ø Fitting	Ø Thread	Reference	Length (mm)			Note
16	1/2"	MF5160P	81	10	800	Long version
20	1/2"	MF3182P	81	10	800	Long version



Double wall-threaded-bracket female elbow

Coudes appliques double à sertir, femelles à visser

Codo fijación doble rosca hembra

Ø Fitting	Ø Thread	Reference			Note
16 x 16	1/2"	MF3138P	10	800	
20 x 20	1/2"	MF3184P	10	800	



Swivel adaptor for manifolds

Manchons à sertir, à visser écrous tournants siège plat

Manguito tuerca loca

Ø Fitting	Ø Thread	Reference			Note
16	1/2"	MM4131P	5	480	
20	1/2"	MM4132P	10	6.000	
20	3/4"	MM4133P	10	7.290	
26	3/4"	MM4134P	5	400	
26	1"	MM4135P	5	400	
32	1"	MM4136P	5	400	
32	1" 1/4	MM4137P	5	400	
40	1" 1/4	MM4138P	5	400	
50	1" 1/2	MM4139P	2	160	
63	2"	MM4140P	2	128	
75	2" 1/2	MM4141P	1	8	



Adaptor for copper

Manchons à sertir, de transition FLUXO® cuivre
Manguito de transición para cobre

Ø Fitting	Reference			Note
16 MLP X 14 COPPER	MM5135P	10	800	
16 MLP X 16 COPPER	MM5136P	10	800	
20 MLP X 22 COPPER	MM5138P	10	800	



Sleeve stainless steel

Bague de sertissage laiton inox
Injerto acero inoxidable

Ø x Thickness (mm)	Reference			Note
16 x 2.0	MB1160P	10	80	
20 x 2.0	MB1200P	10	80	
26 x 3.0	MB1260P	10	800	
32 x 3.0	MB1320P	10	80	
40 x 3.5	MB1400P	5	40	
50 x 4.0	MB1500P	5	40	
63 x 4.5	MB1630P	2	16	
75 x 5.0	MB1750P	1	8	



In-wall ball valve (Chrome Cover Included)

Robinet avec cartouche à encastrer
Válvula de esfera para empotrar

Ø Fitting	Reference			Note
16 x 16	MV1160P	4	-	
20 x 20	MV1200P	4	-	



Extension kit for in wall ball valve

Jeu rallonge pour robinet - Alargadera grifo

Reference			Note
MPR010P	1	-	



Chromed cover for in wall ball valve

Capuchon et rosette pour robinets encastrés
Plafón embellecedor cromado

Reference			Note
MCA010P	4	-	



Threaded Manifolds Adapter

Raccords à compression pour collecteur

Adaptador para colectores

Ø Pipe	Ø Thread	Reference			Note
16 x 2.0	1/2"	MA1160P	2	12.000	
16 x 2.0	3/4"	MA1170P	10	2.000	
20 x 2.0	3/4"	MA1210P	10	-	

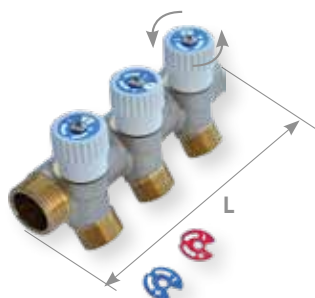

Manifold with stop valves

Collecteurs de distribution avec robinet d'arrêt

Colceter de distribución con válvulas de cierre

Ways	Ø Inlet	Ø Outlets	Reference			L (mm)	Spacing (mm)	Note
2	3/4"	1/2"	MA3172C	6	1.440	98	40	
2	1"	1/2"	MA3162C	1	96	98	40	
3	3/4"	1/2"	MA3173C	1	80	138	40	
3	1"	1/2"	MA3163C	2	324	138	40	
4	3/4"	1/2"	MA3174C	4	960	178	40	
4	1"	1/2"	MA3164C	2	324	178	40	



End cap for manifolds

Bouchons pour collecteurs - Tapón final para colectores

Ø Threads	Type of thread	Reference			Note
3/4"	Male	MT1340C	1	-	
1"	Male	MT1100C	1	-	
1/2"	Female	MT2120C	1	-	
3/4"	Female	MT2340C	1	-	
1"	Female	MT2100C	1	-	

Multilayer accessories

Internal pipe-bending spring

Ressorts de cintrage intérieurs - Muelle de flexión interior



Ø (mm)	Reference			Thickness	Note
16	MMC160A	1	8	2.0	
20	MMC200A	1	8	2.0	
26	MMC260A	1	8	2.0	

Pipe calibrator

Calibreur chanfreineur manuel à poignée 4 diamètres

Calibrador de tubo



Ø (mm)	Reference			Note
14 - 16 - 18 - 20	MCT200A	1	-	
20 - 26 - 32 - 40	MCT400A	1	-	



Countersink calibrator
Calibreur chanfreineur - Calibrador achaflanador

Ø (mm)	Reference			Note
50	MSB200A	1	8	
63	MSB400A	1	8	



Pipe cutter shears
Coupe-tube multicouche - Cizalla cortatubo

Ø (mm)	Reference			Note
from 14 to 26	MCT260A	100	800	



Pipe cutter
Coupe tube automatique Avec ébavureur interne rétractable
Cortador de tubo

Ø (mm)	Reference			Note
from 10 to 40	MS1600C	1	8	
from 50 to 110	MS1610C	1	8	



Bending KIT 16-18-20-25/26-32
Swing 16-18-20-25/26-32 cintreuse arbalète set multicouche
Set doblador de ballesta para tubo multicapa 16-18-20-25/26-32

Reference			Note
MMC132A	1	8	





Battery-powered pressing machine "Rems" (without jaws)
Sertisseuse sur batterie (sans pince)
Engarzadora a batería (sin mordaza)

Model	Ø (mm)	Reference			Note
AKKU-PRESS ACC	10-108	MK3260A	1	8	With automatic return
AKKU-PRESS	10-108	MK3PBOA	1	8	



Electric pressing machine "Rems" (without jaws)
Sertisseuse filaire (sans pince)
Engarzadora eléctrica (sin mordaza)

Model	∅ (mm)	Reference			Note
POWER-PRESS 2000*	10-108	MK2260A	1	8	
POWER-PRESS E	10-108	MK2PE0A	1	8	

* Electrical limit switch

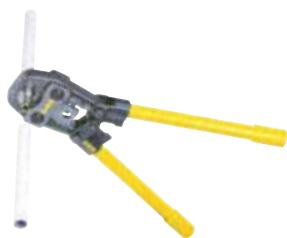



Manual pressing machine "Rems" (without jaws)
Sertisseuses manuel
Engarzadora manual (sin mordaza)

Model	∅ (mm)	Reference			Note
ECO-PRESS	10-26	MK2100A	1	8	



Pressing jaw
Pinces à sertir pour sertisseuses universelles
Mordaza para engarzadora universal

∅ (mm)	Reference			Note
TH 16	MG1160A	1	8	
TH 20	MG1200A	1	8	
TH 26	MG1260A	1	8	
TH 32	MG1320A	1	8	
TH 40	MG1400A	1	8	
TH 50	MG1500A	1	8	
TH 63	MG1630A	1	8	
INTERMEDIATE CLAMP TH 75	MG1750A	1	8	
PRESS RING TH 75	MG1751A	1	8	

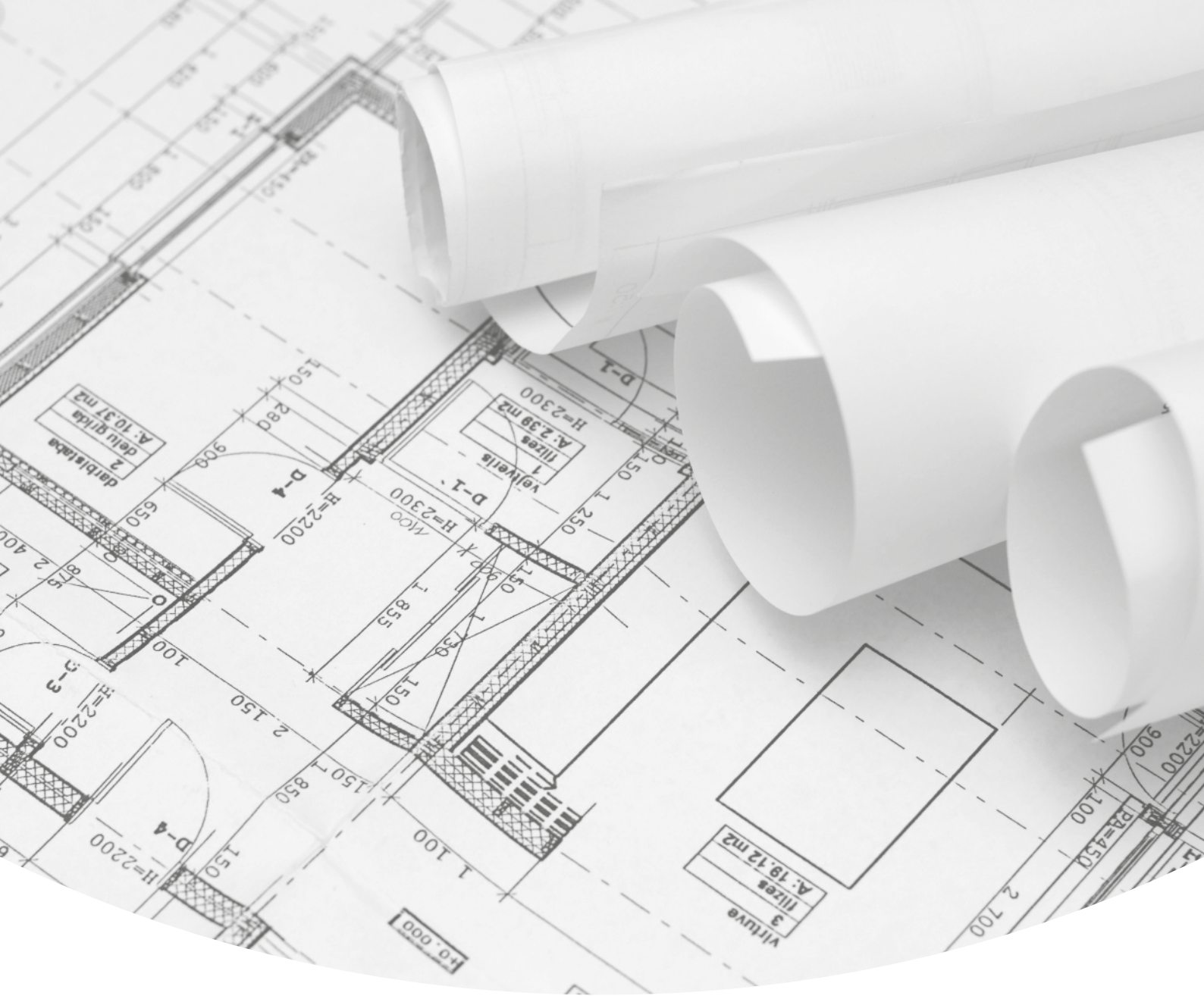

Surface & Floor Drainage System

REDI

alixis

Regulations & Tests

UV RAYS RESISTANCE TESTS

Coverings EN4892



FLOW TESTS

Gullies for buildings EN1253



LOAD RESISTANCE TESTS

Drainage channels EN1433

Floor drains EN1253

Covers and Grills EN124



MECHANICAL RESISTANCE

Voluntary Tests



INGRESS PROTECTION TESTS

Electrical catch basin EN-CEI 60529



Technical Specifications

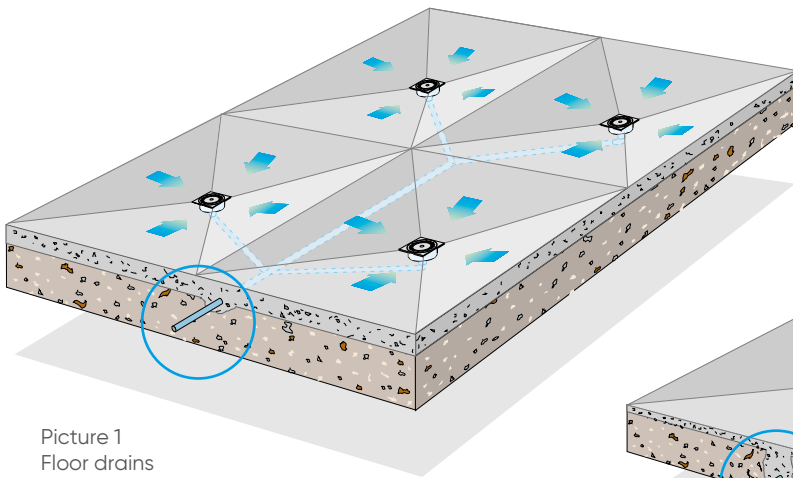

Picture 1
Floor drains

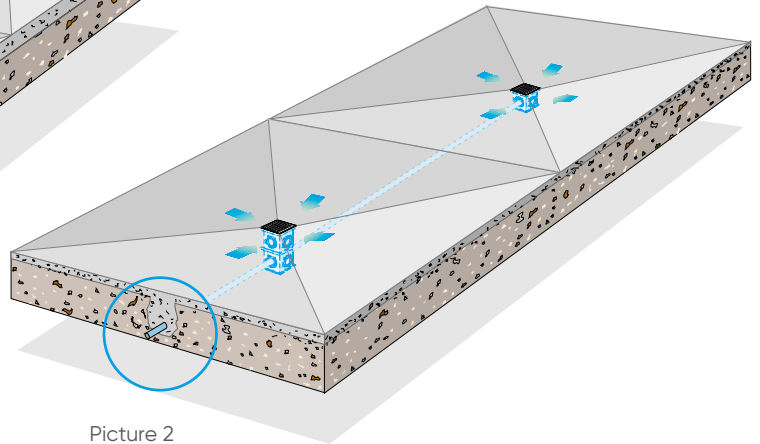

Picture 2
Catch basins and grills

Localized evacuation

This kind of evacuation is mainly considered when it is necessary to gather water trapping every single evacuation point.

In this way, using small drainage accessories called floor drains (see picture 1), a small excavation will be enough to convoy water, especially in low excavation width areas like garages, terraces, etc.

The localized evacuation is often adopted for aesthetical reasons too, because it is possible to place drains in hidden or definite site. In this way catch basins with walkway and light traffic grills are the best solution for areas with no trucks or industrial vehicles passage, because they are designed to optimize transport and installation of the whole drainage system (see pictures 1 - 2).

To get the best performance in a localized evacuation system it is important to:

- calculate number of accessories to be used considering pluviometric intensity, hydraulic discharge of chosen item and roughness of the area to be drained
- divide the whole area into several squares as the number of localized evacuation points
- install the catch basin at the centre of the mentioned drainage points
- keep all the 4 levels of each square with a slight slope inward.

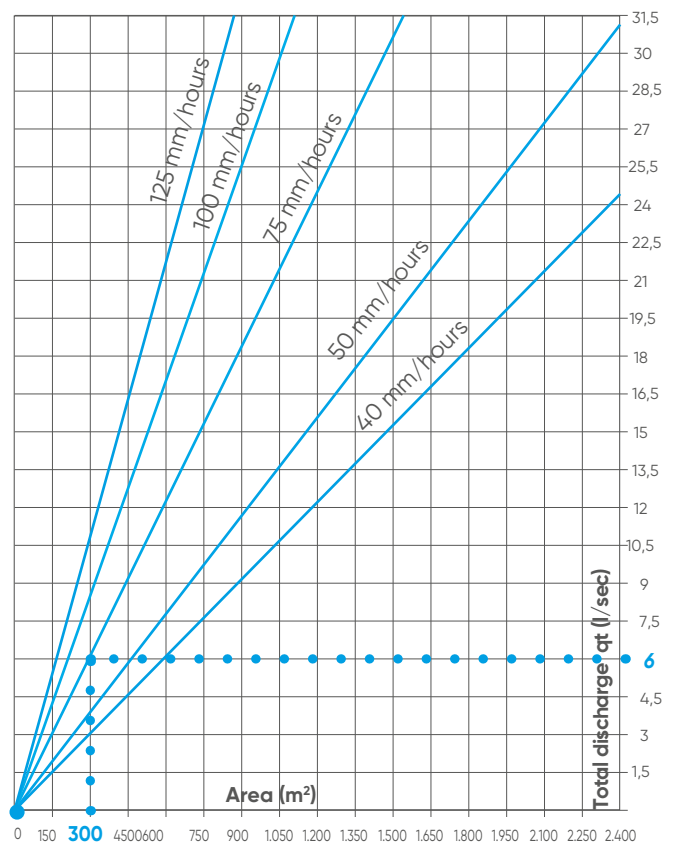

Picture 3
Flow rate calculation

Drainage networks calculation

To establish the correct size of drainage networks it is important to consider the following parameters:

- rain flow to be evacuated Qt (l/sec)
- area to be drained (m²)
- rain intensity (mm/hour)
- ground morphology and slope
- Flow rate of the selected item Qt (l/sec)

In the picture 3 it is possible to link together area to be drained, pluviometric intensity and rain discharge to be evacuated.

For example: Rain intensity = 75 mm/hour
 A Length of area to be drained = 20 m
 B Breadth of area to be drained = 15 m



Selected item for drainage
Floor drain internal
 outlet E193004
 (250x250, outlet Ø100 3,0 l/s certified flow rate)
 N° of floor drains to be installed = ?

1) Total area calculation:

Area = AxB = 20x15 = 300 m²

2) Research in picture 3 of correspondence between area, pluviometric intensity line and related total hydraulic discharge of rain to be evacuated:

about 6 l/s

3) Divide the total hydraulic discharge by single chosen item hydraulic discharge and you will find the total number of floor drains to be placed in the area:

N° floor drains = Qt : Qe = 6 : 3 = 2

Estimate of the total rainwater quantity in the area is the key issue in measuring drainage networks. Data in picture 5 are average results and they are not influenced by external factors (slope and surface characteristics) which can have a relevant impact on these results.

During installation of catch basins and grills it is important to consider the following 2 parameters:

- 4) **hydraulic discharge of pipelines connecting catch basins and sewage network (litres/second)**
- 5) **hydraulic discharge of grills placed on catch basins (litres/seconds)**

Hydraulic discharge of pipelines depends on pipe diameter, slope and roughness. Roughness in particular can influence the hydraulic discharge, because pipelines dirtied by using slow down flow, especially with small slopes.

In this way it is important to link the right pipeline (see table A) with the suitable hydraulic discharge grill (see table B) to obtain a balanced evacuation.

Linear evacuation is more complex. For grill evacuation you can consider table A hydraulic discharge multiplied by the number of grills.

It is important to link the suitable hydraulic discharge grill (table B) with the right pipeline (see table A) to obtain a balanced evacuation. In case hydraulic discharge is higher than pipeline one it will be necessary to connect several different evacuation points.



Picture 4
Pluviometer

Weather station

RAINFALL IN THE WORLD				
State	City	Rainy months* (mm)	Rainy days*	Month*
ARGENTINA	Buenos Aires	120	8	March
BOLIVIA	La Paz	90	21	January
CANADA	Calgary	90	13	June
CHILE	Santiago	85	6	June
CHINA	Lanzhou	29	16	July
CUBA	Havana	170	11	October
DANIMARK	Copenhagen	70	11	July
PHILIPPINES	Manila	480	22	August
FRANCH	Perpignan	85	7	December
JORDAN	Al Aqaba	8	1	December
UNITED KINGDOM	Edimburgh	85	12	July
GREECE	Athens	70	9	December
INDIA	New Delhi	210	12	July
IRAN	Teheran	44	4	January
IRELAND	Dublin	75	14	December
ICELAND	Reykjavik	95	14	October
KENYA	Nairobi	190	18	May
MOROCCO	Marrakech	35	8	December
MEXICO	Mexico City	160	17	July
NEPAL	Kathmandu	375	21	July
NORWAY	Troms	115	16	October
PERU	Lima	2	1	July
POLAND	Warsaw	90	11	July
SPAIN	Granada	70	10	December
USA	Los Angeles	75	4	February
USA	Phoenix	25	3	February
SOUTH AFRICA	Durban	130	9	February
THAILAND	Chiang Mai	290	18	September
TURKEY	Ankara	50	7	May
RUSSIA	Taskent	80	9	March
VENEZUELA	Caracas	110	13	July
VIETNAM	Hanoi	355	16	August













*Data referred to highest monthly rainfall registered during the year

Picture 5
Rainfall data









TABLE A - PIPES FLOW RATE (l/s) WITH DIFFERENT SLOPES

PVC pipe Ø (mm)	0,5%	1%	1,5%	2%	3%	5%	10%
40	0,15	0,26	0,30	0,35	0,43	0,57	0,80
50	0,37	0,52	0,60	0,73	0,89	1,14	1,61
63	0,73	1,04	1,28	1,47	1,77	2,28	3,16
75	1,21	1,63	2,10	2,41	2,94	3,80	5,35
80	1,44	2,05	2,51	2,88	3,54	4,56	6,44
100	2,78	3,91	4,78	5,57	6,78	8,75	12,34
125	5,20	7,36	8,99	10,40	13,00	16,41	23,19
140	6,91	9,78	11,96	13,80	16,90	21,81	30,93
160	9,80	13,74	16,86	19,46	23,86	30,76	43,57
200	16,94	24,01	29,40	33,96	41,61	53,70	75,78
250	30,09	42,54	52,06	60,15	73,64	95,10	134,60
315	54,48	77,11	94,32	108,90	133,40	172,00	244,50

TABLE B - GRILL FLOW RATE (l/s)

Grill	 100x500	 130x500	 130x500 high drainage	 130x500 swimming pool	 130x500 slot	 200x500
Flow rate (l/s)	2,3 (l/s)	1,9 (l/s)	3,6 (l/s)	1,2 (l/s)	0,4 (l/s)	2,8 (l/s)
Grill	 130x1000 PP	 130x1000 galvanized steel grill load class A15	 130x1000 galvanized steel grill load class B125 square mesh 33 x 33	 130x1000 galvanized steel grill load class C250 square mesh 33 x 33		
Flow rate (l/s)	3,5 (l/s)	2,3 (l/s)	7,9 (l/s)	7,5 (l/s)		
Grill	 100x500 "Laser"	 100x500 "Circle"				
Flow rate (l/s)	0,8 (l/s)	1,1 (l/s)				

CHANNEL FLOW RATE (l/s) WITH DIFFERENT SLOPES

Description	H int. (mm)	Roughness PVC - PP	0,5%	1,0%	1,5%	2,0%	3,0%	4,0%	5,0%	10%
	52 130 x 1000	0,02	1,4	2,0	2,5	2,9	3,5	4,1	4,6	6,5
	70 130 x 1000	0,02	2,3	3,3	4,0	4,6	5,7	6,6	7,3	10,4
	90 130 x 1000	0,02	3,1	4,4	5,4	6,3	7,7	8,8	9,9	14,0
	130 130 x 1000	0,02	4,8	6,8	8,3	9,6	11,7	13,5	15,1	21,4
	50 100 x 500	0,02	0,5	0,7	0,9	1,0	1,3	1,4	1,6	2,3
	70 130 x 500	0,02	1,0	1,4	1,7	1,9	2,4	2,8	3,1	4,4
	134 130 x 500	0,02	3,3	4,7	5,7	6,6	8,1	9,4	10,5	14,8
	94 200 x 500	0,02	3,5	5,0	6,1	7,0	8,6	9,9	11,1	15,7
	170 200 x 500	0,02	9,6	13,6	16,6	19,2	23,5	27,2	30,4	43,0

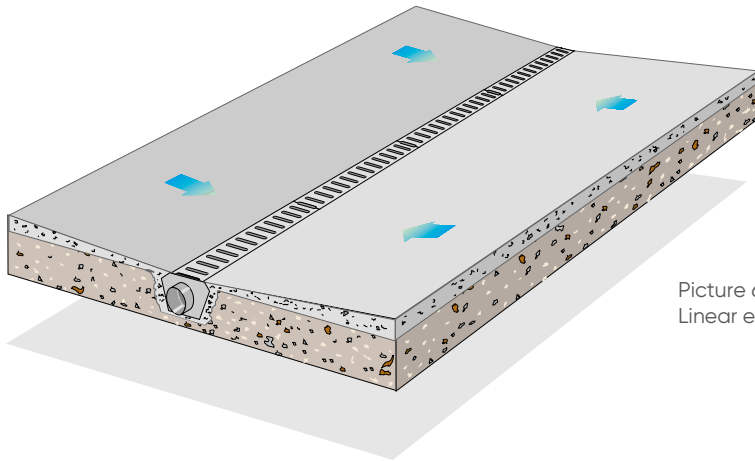

Picture 6
Linear evacuation

TABLE C - ROUGHNESS COEFFICIENT OF INTERNAL CHANNEL SURFACE

Channel description	Bazin Υ (m ^{1/2})
Channel made of PVC, PP, PE	0,02
Channels made of concrete	0,10
Channels made of concrete (low level of maintenance)	0,23 ÷ 0,36
Channels made of stone	0,46
Channels made of concrete with grass on the bottom	1,30
Abandoned channels with vegetation	2,0 ÷ 2,3

Linear evacuation

All the underground connectors for rain gathering can be partially substituted by superficial drainage channels with grills. These channels can be placed in flat open areas without digging limitations. Linear drainage system permits an easier installation than localized one, because it is less difficult to project the drainage plane.

All ground drained in this way are flatter and more suitable for vehicular traffic. Both evacuation systems are efficient in case of meteoric water gathering. There are particular cases, when water reaches drainage area with high speed (like for example in a swimming pool border or between underground garages and ramps or along borders with slope changes), in which it is necessary to gather water for a wide area set at 90° of the flow direction.

REDI proposes its range of channels with walkway and light traffic grills (A15, B125, C250 load classes) to get an efficient linear evacuation.

In case of linear evacuation drainage channels are chosen both for granted load resistance and for water quantity to be drained.

Estimate of quantity of water to be drained

Q_t = quantity of water to be drained

A = area to be drained

P = average quantity of rainfall

$Q_t = A \times P$

For example considering daily highest rainfall tables

it is possible to determine the quantity of water to be drained over an area 10x5 mt characterized by a daily highest rainfall value between 90 mm/day - 120 mm/day (minimum-maximum):

Area = 10 x 5 m = 50 m²

Hypothetical average rainfall estimated = 105 mm/hour

$Q_t = 50 \times 105 = 5.250$ mm/hour

5.250 mm/hour corresponding to 1,46 mm/second (1,46 l/s).

Estimate of channels hydraulic discharge

Channels hydraulic discharge have been calculated supposing hydraulic discharge (Q) has uniform motion. Chézy's formula permits to calculate respectively Speed (V) and Hydraulic discharge (Q):

$$Q = A \times V$$

$$V = C \sqrt{R \times i}$$

Coefficient C can be calculated with Bazin's formula $C = 87 / (1 + \Upsilon / \sqrt{R})$ where A is the section, R is the average radius of the channel and Υ is the roughness coefficient of the internal channel surface. As indicated in the table on the side the roughness coefficient of plastics (PVC and PP) is much lower if compared with other materials.

Grills flow discharge has to be linked with channels flow discharge in table below. If hydraulic discharge is higher than channels one other vertical or lateral pipes can be connected to the channels, improving the hydraulic discharge of the all system.

Materials

The surface drainage system products are made by moulding the following plastics:

- Polyvinyl chloride (PVC), thermoplastic polymer obtained from polymerization of vinyl chloride. PVC is nowadays more and more largely used in buildings, thanks to its resistance to external atmospheric agents and to mechanical solicitations.
- Polypropylene (PP), thermoplastic polymer obtained from polymerization of propylene. PP, thanks to its versatility, is largely used in buildings, mainly when product doesn't require specific resistance performances.

-Acrylonitrile - Butadiene - Styrene (ABS), thermoplastic copolymer obtained from polymerization of Acrylonitrile, Butadiene and Styrene. ABS, thanks to its characteristics is particularly used for shock resistant items which satisfy aesthetical requirements.

Raw materials used to realize surface DRAINAGE SYSTEM products are subjected to periodical controls in chemical laboratories. Their formulation has been carefully studied to optimize their chemical and mechanical resistances. The following tables are the result of several laboratory tests. It is important to check the real behaviour during practical use.

TECHNICAL CHARACTERISTICS

PVC mechanical features (23°C)

Characteristics	Test	Size	Result*
Yield point	ISO 527	Kg/cm ²	530
Breaking load	ISO 527	Kg/cm ²	430
Elongation at break	ISO 527	%	70/80
Traction stretch	ISO 527	Kg/cm ²	34.000

PVC physical features

Characteristics	Test	Size	Result*
Mass volume	ISO 1183	Kg/dm ³	1,43
Vicat softening temperature	ISO 306-B	°C	80
Thermal linear expansion coefficient	/	mm/m°C	0,07

* = Data obtained from tests effected: • Test tube type ISO 2 • Traction speed = 5 mm/min

** = Temperature: • min. -10° • max. 60°

PP mechanical features (23°C)

Characteristics	Test	Size	Result*
Yield point	ISO 527	Kg/cm ²	260
Breaking load	ISO 527	Kg/cm ²	200
Elongation at break	ISO 527	%	20/30
Traction stretch	ISO 527	Kg/cm ²	17.000

PP physical features

Characteristics	Test	Size	Result*
Mass volume	ISO 1183	Kg/dm ³	0,92
Vicat softening temperature	ISO 306-B	°C	94
Thermal linear expansion coefficient	/	mm/m°C	0,15

* = Data obtained from tests effected: • Test tube type ISO 1 • Traction speed = 50 mm/min

** = Temperature: • min. 0° • max. 60°

PP - Chemical resistance

Product	Conc. %	Temp. 20 °C	Temp. 60 °C	Product	Conc. %	Temp. 20 °C	Temp. 60 °C
ACETIC ACID	60	S	L	HYDROGEN	100	S	S
ACETIC ACID MONOCHLORIDE	SOL.	S	L	HYDROGEN DIOXIDE	30	S	L
ACETIC ALDEHYDE	33	L	NS	HYDROGEN SULPHIDE	100	S	S
ACETIC ANHYDRIDE	100	L	NS	ISOCTANE	100	L	S
ACETONE	100	S	S	LACTIC ACID	10	S	L
ADIPIC ACID	-	-	-	LACTIC ACID	10-90	L	L
ALLYL ALCOHOL	96	S	S	LEAD TETRAETHYL	100	S	-
ALUMINUM CHLORIDE	SOL. SAT.	S	S	MAGNESIUM SULPHIDE	SOL. SAT.	S	S
ALUMINUM SULPHATE	SOL. SAT.	S	S	MALEIC ACID	SOL. SAT.	S	L
AMMONIA (GAS)	100	S	S	METHYL ALCOHOL	100	S	L
AMMONIA (LIQUID)	100	S	L	METHYL METHACRYLATE	100	NS	NS
AMMONIA (SOLUTION)	SOL. DIL.	S	L	METHYLENE CHLORIDE	100	NS	NS
AMMONIUM CHLORIDE	SOL. SAT.	S	S	MILK	-	S	S
AMMONIUM FLUORIDE	-	-	-	MINERAL OIL	100	L	L
AMMONIUM NITRATE	SOL. SAT.	S	S	N-HEPTANE	100	L	NS
AMMONIUM SULPHATE	SOL. SAT.	S	S	NICKEL SULPHIDE	SOL. SAT.	S	S
AMYL ACETATE	100	NS	NS	NICOTINIC ACID	CONC.	S	S
AMYL ALCOHOL	100	S	L	NITRIC ACID	<25	L	NS
ANILINE	100	S	L	NITRIC ACID	50	NS	NS
ANILINE	SOL. SAT.	S	L	OLEIC ACID	100	L	L
ANILINE HYDROCHLORIDE	SOL. SAT.	-	-	OLEUM	10% of SO ²	NS	NS
ANTIMONY CHLORIDE	90	S	S	OXALIC ACID	25	S	L
ARSENIC ACID	SOL. DIL.	S	-	OXALIC ACID	SOL. SAT.	L	L
BEER	-	S	S	OXIGEN	SOL. SAT.	L	L
BENZALDEHYDE	100	S	-	PETROL	80/20	NS	NS
BENZENE	100	NS	NS	PETROLEUM	100	L	NS
BENZOIC ACID	SOL. SAT.	S	L	PHENOL	SOL. SAT.	S	S
BORAX	SOL. SAT.	S	L	PHOSPHINE	100	S	L
BORIC ACID	SOL. DIL.	S	L	PHOSPHOR OXICHLORIDE	100	L	L
BROMINE (LIQUID)	100	NS	NS	PHOSPHORIC ACID	30	S	L
BROMINE ACID	10	S	-	POTASSIUM BICHROMATE	SOL. 20	S	S
BUTADIENE	100	S	S	POTASSIUM BROMIDE	SOL. SAT.	S	S
BUTANE	100	S	-	POTASSIUM CHLORIDE	SOL. SAT.	S	S
BUTYL ACETATE	100	NS	NS	POTASSIUM CHROMATE	40	S	S
BUTYL PHENOL	100	NS	NS	POTASSIUM CYANIDE	SOL.	S	S
BUTYLENE	100	S	L	POTASSIUM FERRICYANIDE	SOL. SAT.	S	S
BUTYRIC ACID	20	S	L	POTASSIUM FERROCYANIDE	SOL. SAT.	S	S
BUTYRIC ACID	98	NS	NS	POTASSIUM HYDROXIDE	SOL.	S	S
CALCIUM CHLORIDE	SOL. SAT.	S	S	POTASSIUM NITRATE	SOL. SAT.	S	L
CALCIUM NITRATE	50	S	S	POTASSIUM PERMANGANATE	20	S	S
CARBON DIOXIDE	100	S	S	POTASSIUM PERSULFATE	SOL. SAT.	S	L
CARBON SULPHIDE	100	S	-	PROPANE (GAS LIQUID)	100	S	-
CARBON TETRACHLORIDE	100	NS	NS	PROPIONIC ACID	50	S	S
CHLORINE (DRY GAS)	100	NS	NS	PYRIDINE	100	NS	NS
CHLORINE (LIQUID)	SOL. SAT.	NS	NS	SEA WATER	-	S	L
CHLOROSULPHONIC ACID	100	NS	NS	SILVER NITRATE	SOL. SAT.	S	L
CHROMIC ACID	-	-	-	SOAP	SOL.	S	S
CITRIC ACID	SOL. SAT.	S	S	SODIUM BISULPHITE	SOL. SAT.	S	S
COPPER CHLORIDE	SOL. SAT.	S	S	SODIUM CHLORATE	SOL. SAT.	S	S
COPPER FLUORIDE	2	S	S	SODIUM CHLORIDE	SOL. SAT.	S	S
CREOSOL	100	L	NS	SODIUM FERRICYANIDE	SOL. SAT.	S	S
CRESOL ACID	SOL. SAT.	NS	NS	SODIUM HYDROXIDE	SOL.	S	S
CROTONIC ALDEHYDE	100	NS	NS	SODIUM HYPOCHLORITE	25	L	NS
CYCLOHEXANOL	100	L	NS	SODIUM HYPOCHLORITE	100 (13% Cl.)	S	L
CYCLOHEXANONE	100	L	NS	SODIUM SILICATE	SOL.	S	S
DEVELOPING BATH	-	S	S	SODIUM SULPHITE	SOL. SAT.	S	L
DEXTRENE	SOL. SAT.	-	-	SULPHUR ACID	SOL.	S	S
DIBUTYL PHTHALATE	100	NS	L	SULPHUR ANHYDRIDE	100 (LIQUID)	S	L
DICHLOROETHYLENE	100	NS	NS	SULPHUR ANHYDRIDE	100 (DRY)	L	NS
DIGLYCOLIC ACID	18	S	-	SULPHURIC ACID	40-90	L	L
DIMETHYLAMMINE	30	S	-	SULPHURIC ACID	96	NS	NS
ETHYL ACETATE	100	NS	NS	SULPHURIC CHLORIDE	100	NS	NS
ETHYL ALCOHOL	95	S	L	SULPHURYL CHLORIDE	100	NS	NS
ETHYL BENZENE	100	NS	NS	TANNIC ACID	SOL.	S	S
ETHYL ETHER	100	S	-	TARTARIC ACID	SOL.	S	S
ETHYLENE GLYCOL	CONC.	S	S	TETRACHLOROETHENE	100	NS	NS
FLUORINE	100	NS	NS	THIOPHENE	100	L	L
FORMALDEHYDE	SOL. DIL.	S	S	TIN CHLORIDE	SOL. SAT.	S	S
FORMALDEHYDE	40	S	S	TOLUENE	100	NS	NS
FORMIC ACID	1-50	L	NS	TRICHLOROETHYLENE	100	NS	NS
FURFURAL ALCOHOL	100	NS	NS	TURPENTINE (OIL)	100	NS	NS
GLUCOSE	SOL. SAT.	S	L	UREA	10	S	L
GLYCERIN	100	S	S	VASELINE	-	L	L
GLYCOLIC ACID	30	S	S	VINAGRE	-	S	S
GOLDEN SYRUP	SOL.	S	L	VINYL ACETATE	100	NS	NS
HYDROBROMIC ACID	50	-	-	WINE	-	S	S
HYDROCHLORIC ACID	30	L	NS	XYLENE	100	NS	NS
HYDROFLUORIC ACID	60	L	NS	YEAST	SOL.	S	L

TS = Without corrosion L = Limited corrosion NS = Corrosion

For any special application, please contact the REDI Technical Service beforehand.

PVC - Chemical resistance

Product	Conc. %	Temp. 20 °C	Temp. 60 °C	Product	Conc. %	Temp. 20 °C	Temp. 60 °C
ACETIC ACID	60	S	L	HYDROFLUORIC ACID	60	L	NS
ACETIC ACID MONOCHLORIDE	SOL.	S	L	HYDROGEN	100	S	S
ACETIC ALDEHYDE	100	NS	-	HYDROGEN DIOXIDE	30	S	S
ACETIC ANHYDRIDE	100	NS	NS	HYDROGEN SULPHIDE	100	S	S
ACETONE	100	NS	NS	IRON CHLORIDE	SOL. SAT.	S	S
ADIPIC ACID	SOL.SAT.	S	L	LACTIC ACID	10	S	L
ALLYL ALCOHOL	90	L	S	LACTIC ACID	10-90	L	NS
ALUMINUM CHLORIDE	SOL. SAT.	S	S	LEAD ACETATE	SOL. SAT.	S	S
ALUMINUM SULPHATE	SOL. SAT.	S	S	LEAD TETRAETHYL	100	S	-
AMMONIA (AQUEOUS)	100	L	NS	MAGNESIUM CHLORIDE	SOL. SAT.	S	S
AMMONIA (GAS)	100	S	S	MAGNESIUM SULPHIDE	SOL. SAT.	S	S
AMMONIA (SOLUTION)	SOL. DIL.	S	L	MALEIC ACID	SOL. SAT.	S	L
AMMONIUM CHLORIDE	SOL. SAT.	S	S	METHYL ALCOHOL	100	S	L
AMMONIUM FLUORIDE	20	S	L	METHYL METHACRYLATE	100	NS	NS
AMMONIUM NITRATE	SOL. SAT.	S	S	METHYLENE CHLORIDE	100	NS	NS
AMMONIUM SULPHATE	SOL. SAT.	S	S	MILK		S	S
AMYL ACETATE	100	NS	NS	NICKEL SULPHIDE	SOL. SAT.	S	S
AMYL ALCOHOL	100	S	L	NICOTINIC ACID	CONC.	S	S
ANILINE	100	NS	NS	NITRIC ACID	<46	S	L
ANILINE	SOL. SAT.	NS	NS	NITRIC ACID	46-98	NS	NS
ANILINE HYDROCHLORIDE	SOL. SAT.	NS	NS	OILS		S	S
ANTIMONY CHLORIDE	90	S	-	OLEIC ACID	100	S	S
ARSENIC ACID	SOL. DIL.	S	-	OLEUM	10% OF SO	NS	NS
BEER		S	S	OXALIC ACID	SOL. DIL.	S	L
BENZALDEHYDE	0,1	NS	NS	OXALIC ACID	SOL. SAT.	S	S
BENZENE	100	NS	NS	OXYGEN	100	S	S
BENZOIC ACID	SOL. SAT.	L	NS	OZONE	100	NS	NS
BORAX	SOL. SAT.	S	L	PERCHLORIC ACID	10	S	L
BORIC ACID	SOL. DIL.	S	L	PERCHLORIC ACID	70	L	NS
BROMINE (LIQUID)	100	NS	NS	PETROL	80/20	NS	NS
BROMINE ACID	10	S	-	PHENOL	90	NS	NS
BUTADIENE	100	S	-	PHOSPHINE	100	S	S
BUTANE	100	S	-	PHOSPHOR TRICHLORIDE	100	NS	-
BUTYL ACETATE	100	NS	NS	PHOSPHORIC ACID	30	S	L
BUTYL PHENOL	100	NS	NS	PICRIC ACID	SOL. SAT.	S	S
BUTYLENE	100	S	L	POTASSIUM BICHROMATE	40	S	S
BUTYRIC ACID	20	S	L	POTASSIUM BROMIDE	SOL. SAT.	S	S
BUTYRIC ACID	98	NS	NS	POTASSIUM CHLORIDE	SOL. SAT.	S	S
CALCIUM CHLORIDE	SOL. SAT.	S	S	POTASSIUM CHROMATE	40	S	S
CALCIUM NITRATE	50	S	S	POTASSIUM CYANIDE	SOL.	S	S
CARBON DIOXIDE	100	S	S	POTASSIUM FERRICYANIDE	SOL. SAT.	S	S
CARBON SULPHIDE	100	NS	NS	POTASSIUM FERROCYANIDE	SOL. SAT.	S	S
CARBON TETRACHLORIDE	100	NS	NS	POTASSIUM HYDROXIDE	SOL.	S	S
CETYL ACID	100	S	S	POTASSIUM NITRATE	SOL. SAT.	S	S
CHLORINE (DRY GAS)	100	L	NS	POTASSIUM PERMANGANATE	20	S	S
CHLORINE (LIQUID)	SOL. SAT.	L	NS	POTASSIUM PERSULFATE	SOL. SAT.	S	L
CHLOROSULPHONIC ACID	100	L	NS	PROPANE (GAS LIQUID)	100	S	-
CHROMIC ACID	1-50	S	L	PYRIDINE	100	NS	-
CITRIC ACID	SOL. SAT.	S	S	SEA WATER		S	L
COPPER CHLORIDE	SOL. SAT.	S	S	SILVER NITRATE	SOL. SAT.	S	L
COPPER FLUORIDE	2	S	S	SOAP	SOL.	S	L
CREOSOL	SOL. SAT.	-	NS	SODIUM BENZOATE	35	S	L
CREOSOL ACID	SOL. SAT.	NS	NS	SODIUM BISULPHITE	SOL. SAT.	S	S
CROTONIC ALDEHYDE	100	NS	NS	SODIUM CHLORATE	SOL. SAT.	S	S
CYCLOHEXANOL	100	NS	NS	SODIUM FERRICYANIDE	SOL. SAT.	S	S
CYCLOHEXANONE	100	NS	NS	SODIUM HYDROXIDE	SOL.	S	L
DEVELOPING BATH		S	S	SODIUM HYPOCHLORITE	100 (13% CL.)	S	L
DEXTRINE	SOL. SAT.	S	L	SODIUM SULPHITE	SOL. SAT.	S	L
DICHLOROETHYLENE	100	NS	NS	SUGAR	SOL. SAT.	S	S
DIGLYCOLIC ACID	18	S	L	SULPHUR ACID	SOL.	S	S
DIMETHYLAMMINE	30	S	-	SULPHUR ANHYDRIDE	100 (LIQUID)	L	NS
ETHYL ACETATE	100	NS	NS	SULPHUR ANHYDRIDE	100 (DRY)	L	NS
ETHYL ACRYLATE	100	NS	NS	SULPHURIC ACID	40-90	S	L
ETHYL ALCOHOL	95	S	L	SULPHURIC ACID	96	L	NS
ETHYL ETHER	100	NS	L	TANNIC ACID	SOL.	S	S
ETHYLENE GLYCOL	CONC.	L	L	TARTARIC ACID	SOL.	S	S
FLUOSILICIC ACID	32	S	S	TIN CHLORIDE	SOL. SAT.	S	S
FORMALDEHYDE	SOL.	S	S	TOLUENE	100	NS	NS
FORMALDEHYDE	40	S	S	TRICHLOROETHYLENE	100	NS	NS
FORMIC ACID	1-50	S	L	TRIMETHYL PROPANE	<10	S	L
FURFURAL ALCOHOL	100	NS	NS	UREA	10	S	L
GLUCOSE	SOL. SAT.	S	L	URINE		S	L
GLYCERIN	100	S	S	VINAGRE		S	S
GLYCOLIC ACID	30	S	S	VINYL ACETATE	100	NS	NS
GOLDEN SYRUP	SOL.	S	L	WINE		S	S
HYDRAZINE BENZENE	100	NS	NS	XYLENE	100	NS	NS
HYDRAZINE BENZENE CLORIC	97	NS	NS	YEAST	SOL.	S	L
HYDROBROMIC ACID	50	S	L	ZINC CHLORIDE	SOL. SAT.	S	S
HYDROCHLORIC ACID	>30	S	S				

TS = Without corrosion L = Limited corrosion NS = Corrosion

For special applications it is recommended to contact the REDI Technical Department.



2.3 MODULAR DRAINAGE CHANNELS

2.3 SLOT GRILL CONCEALED

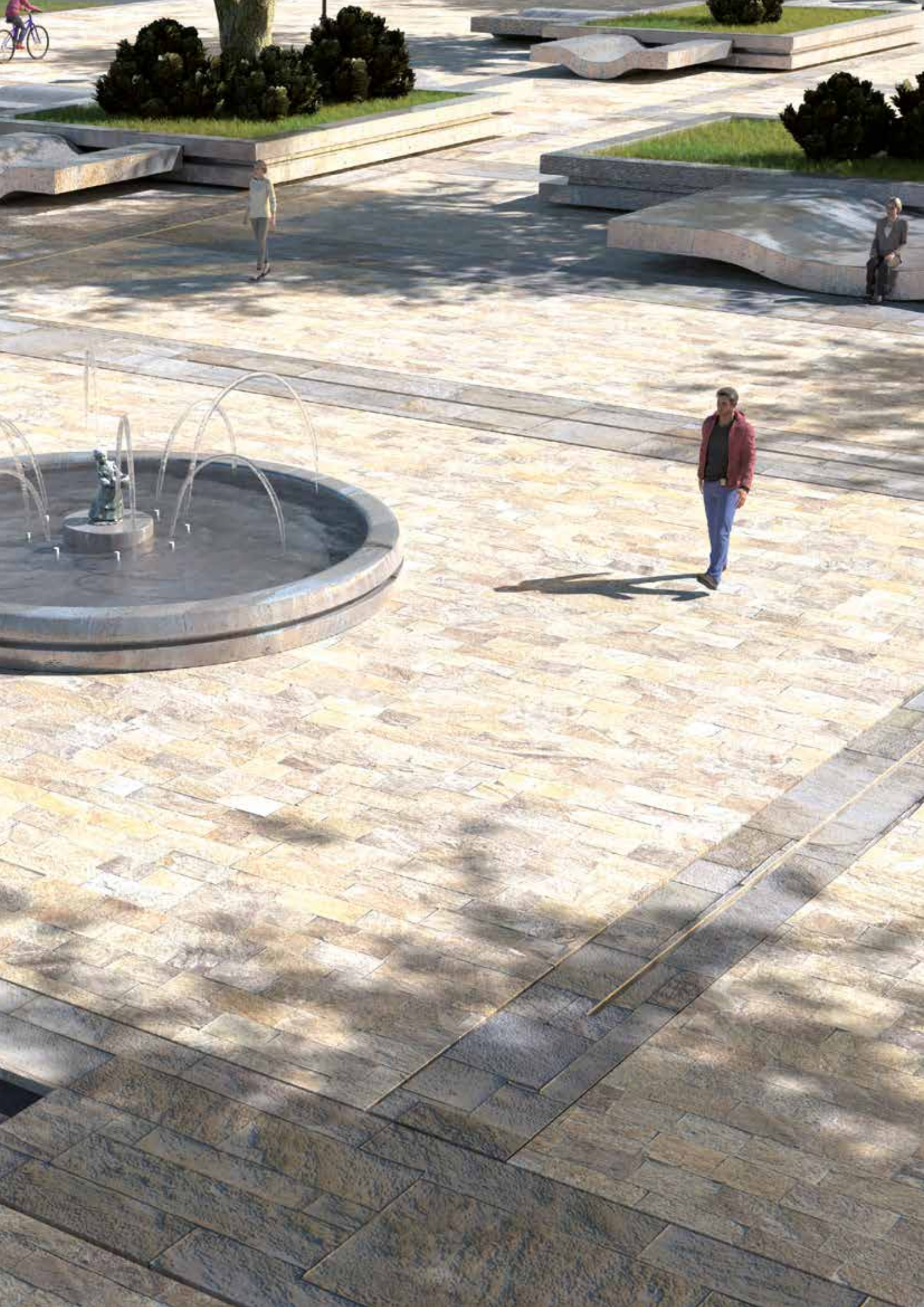

Catch Basins, Covers and Grills

REDI

2.1 CATCH BASIN-COVERS-GRILLS

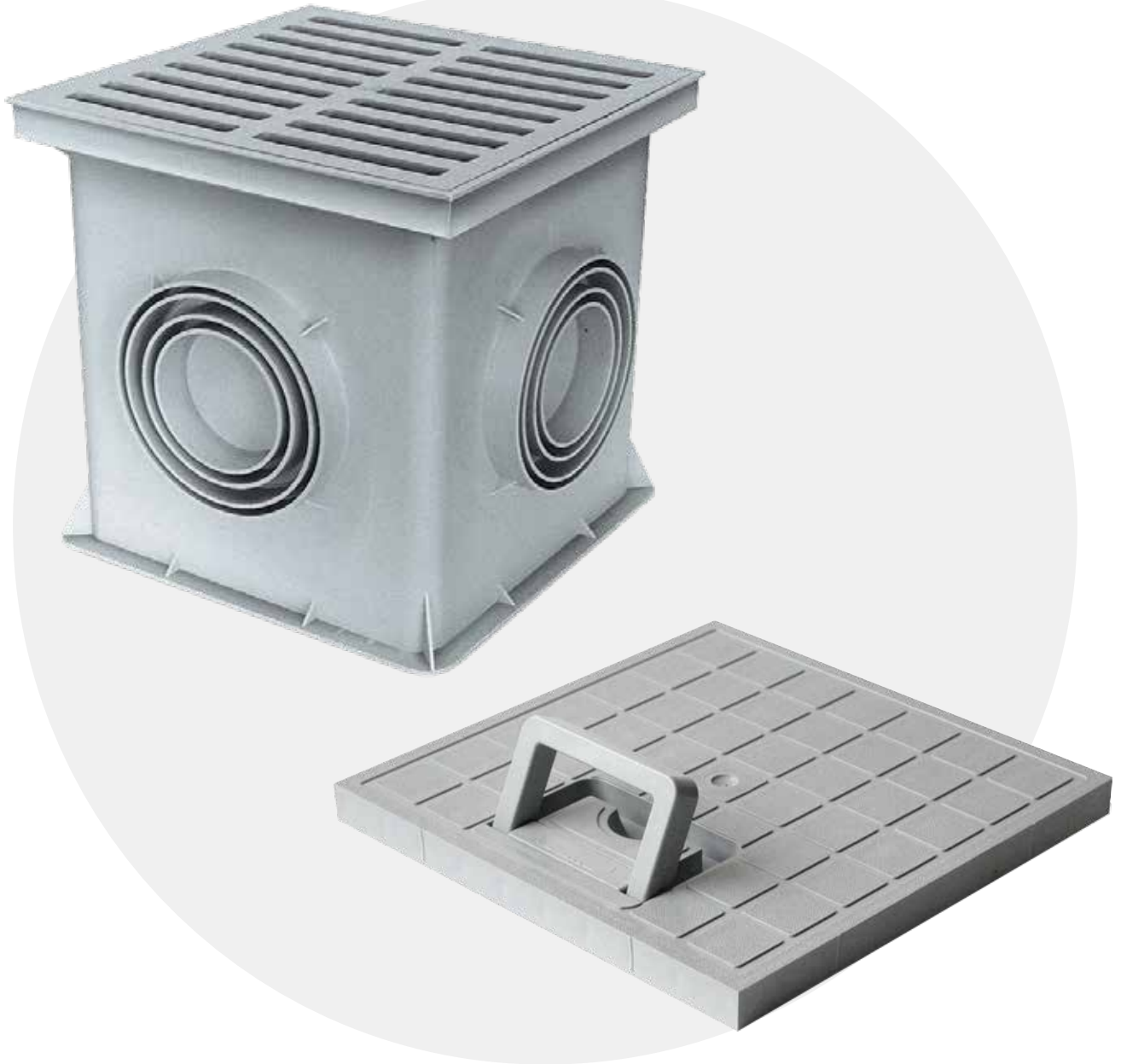

Catch Basins, Covers and Grills

Test methods

REDI brand products performances are tested in accordance to EN regulations.

Two tests are carried out in particular:

- waterflow control (discharge test)
- mechanical resistance (breaking test).

Discharge test

This test is carried out in compliance with EN1253-1 cap. 8.11. The discharge capacity (lt/sec) is indicated with the symbol:



Test on mechanical stress resistance

This test is carried out in compliance with EN124 Standard. All certificates are available on request. The breaking force (in KN) is indicated with the symbol:

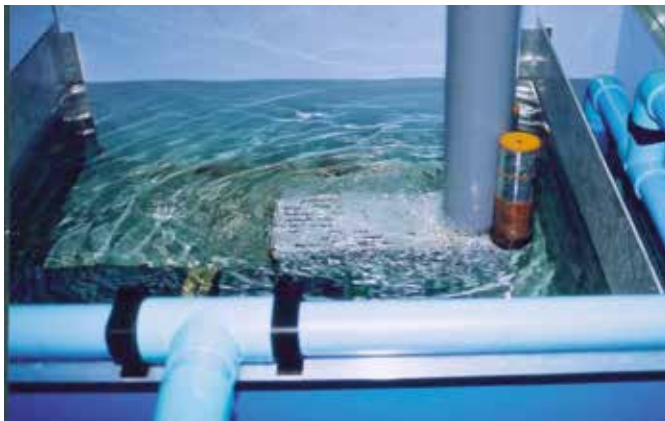

Discharge Test on a rainwater collector.



Breaking test on a light duty traffic grill.

Plastics Light solution

Concrete Heavy solution



Polypropylene catch basin with PVC Grill



Concrete catch basin with concrete cover



Easy to open



Technical accessories



Difficult to open



No accessories



Light solution



Heavy solution



No leakage



Easy to open



Leakage (in the long term)



Difficult to open



Long time resistance of the junctions



Adaptable riser



Short time resistance of the junctions



No extension

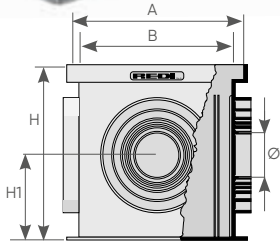

PP Catch basin

Regard de branchement en PP - Arqueta de registro PP

Dim (mm)	Reference Grey Ral 7035	Reference Green Ral 6005			A (mm)	B (mm)	H (mm)	H1 (mm)	Ø outlet (mm)
200x200	Y222004	Y22200V	1	120	189	161	200	100	63; 82; 100
200x200	Y212104	-	1	120	189	161	200	100	75; 90; 110 (export)
300x300	Y223004	Y22300V	1	48	286	253	297	140	82; 100; 125; 140
300x300	Y213104	-	1	48	286	253	297	140	75; 90; 110; 125; 160 (export)
400x400	Y224004	Y22400V	1	18	384	355	397	200	100; 125; 140; 160; 200; 250
550x550	Y225504	Y22550V	1	8	535	500	520	250	160; 200; 250; 315

Material: Polypropylene

Use: inspection chamber for rain and waste waters.

Benefits:

- light-weight
- easier to install than concrete chambers
- fully injection moulding
- high durability
- preformed cutouts for insertion of pipes in various sizes on all sides
- smooth rounded angles for a higher shock resistance
- it may be used as a connector block for electric systems.

Note: a concrete floor seating is recommended to prevent subsidence.

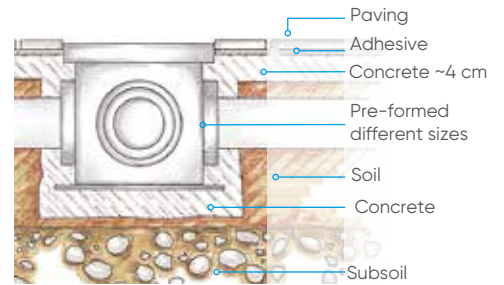

Baffle removal

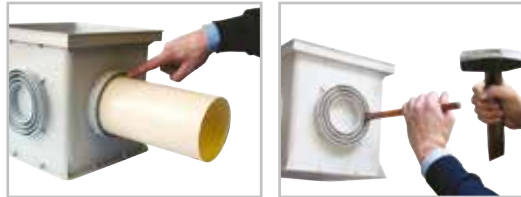

PP Bottomless extension

Rehause sans fond en PP - Alargadera arqueta PP

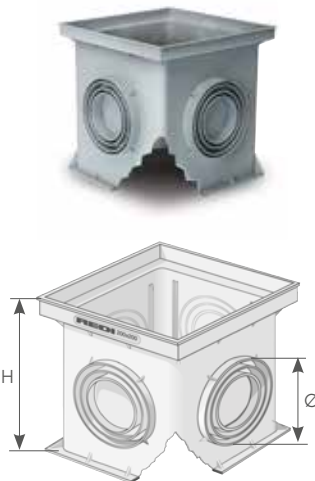

Dim (mm)	Reference Grey Ral 7035	Reference Green Ral 6005			H (mm)	Ø outlet (mm)
200x200	Y332004	Y33200V*	1	120	200	63; 82; 100
200x200	Y312104	*	1	120	200	75; 90; 110 (export)
300x300	Y333004	Y33300V*	1	48	297	82; 100; 125; 140
300x300	Y313104	*	1	48	297	75; 90; 110; 125; 160 (export)
400x400	Y334004	Y33400V*	1	18	397	100; 125; 140; 160; 200; 250
550x550	Y335504	Y33550V*	1	8	520	160; 200; 250; 315

*upon request

* For a minimum quantity available in the green color.

Material: Polypropylene

Colour: Grey RAL 7035

Use:

- extension
- leaking chamber for underground disposal of rain water
- inspection chamber for irrigation plants
- it may be used as a connector block for electric systems.

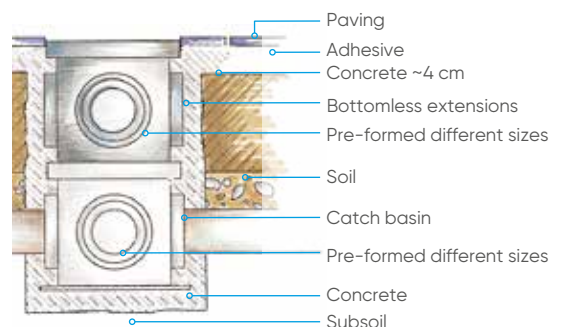



PP Catch basin for electric cables with watertight cover

Regard d'interface pour câbles électriques avec tampon étanche en PP
Arqueta registro para cables eléctricos en PP, con cierre estanco

Dim (mm)	H (mm)	Reference			Colour	Colour
250x250	240	E802504	1	60	Grey	Ral 7035 Grey
250x250	240	E80250V*	1	60	Green	Ral 6005 Green

Material: Polypropylene
 Use : inspection chamber for electric cables
 Inlet/outlet : Ø40, Ø50, Ø63, Ø75 mm
 Condensation discharge Ø 20 mm
 Screws for cover fastening included

*upon request



Tested by **ISTITUTO GIORDANO**
Qualità al Futuro.

IP 67 certificate in accordance to CEI EN60529 norm

Protection against temporary water (max 30' at 1 mt depth)

Total protection against bodies and dust penetration



All products can be classified in load class A15 in accordance with regulation EN124 (resistance >15 KN). All tests have been carried out at internal laboratories in Aliaxis Group.





Easy to open



Watertight



Internal support for electrical boxes



Condensation discharge



Anti-slip cover Customizable on request



Stacking - Pre cut bottom



PP Removable baffle plate

Plaque-siphon pour regard en PP - Placa para sifón PP

Dim (mm)	Reference Grey Ral 7035			Note
200x200	Y112004	10	1200	
300x300	Y113004	8	768	
400x400	Y114004	5	120	
550x550	Y115504	1	90	

Material: Polypropylene
Use: to trap inlet pipe

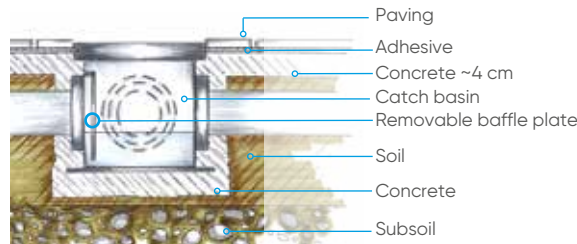

Installation: the REDI catch basin is provided with special slots for the baffle to be fitted in.



PP Trap bell for catch basin

Cloche siphon de siphon de sol en PP

Campana sifónica para arqueta registro PP

Dim (mm)	Reference Grey Ral 7035			H	H1	L	Ø	Note
300x300	E273304*	1	156	210	58	251	125	
400x400	E274404*	1	54	300	75	350	160	

Material: Polypropylene
Use: To trap inspection catch basin.

*upon request

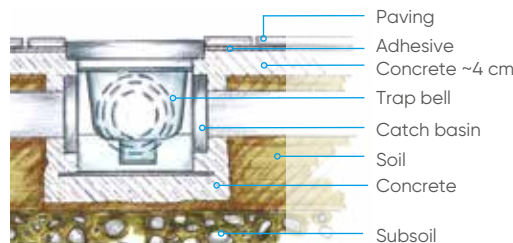
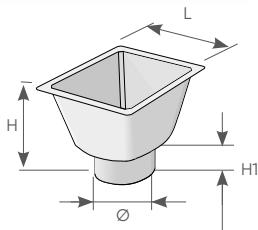

Installation: the trap bell should be placed into the bottomless catch pit on the specially provided site stops.



PP Trap bell for catch basin

Cloche siphon de siphon de sol en PP

Campana sifónica para alargadera de arqueta

Dim (mm)	Reference Grey Ral 7035			A (mm)	B (mm)	C (mm)	D (mm)	Note
300 x 300	E275504*	1	180	249	238	5	160	
400 x 400	E276604	4	72	348	308	15	210	

Material: Polypropylene
Use: to trap bottomless extension

*upon request

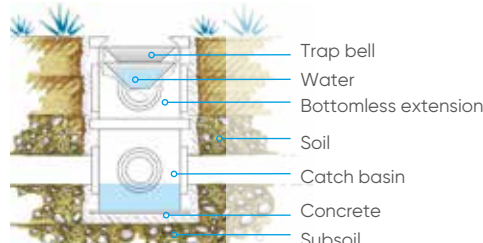
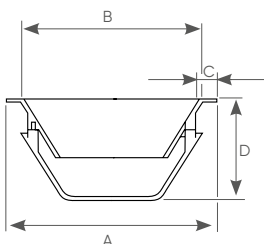

Installation: the trap bell should be placed into the bottomless catch pit on the specially provided site stops.

PP Short riser

Rehausse en PP (court) - Alargadera modular PP

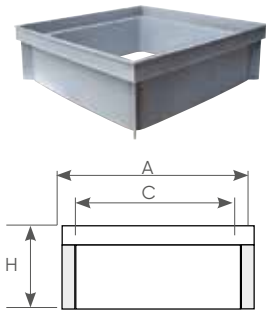

Dim (mm)	Ref. Grey Ral 7035			H (mm)	A (mm)	C (mm)	Note
200x200	Y332204	1	240	100	189	161	
300x300	Y333204	1	168	100	286	253	
400x400	Y334204	1	90	100	384	355	
550x550	Y335204	1	16	315	532	500	

PP frame for pipe inspection

Cadre Carré/Rond en PP - Cerco para tubo de extensión PVC

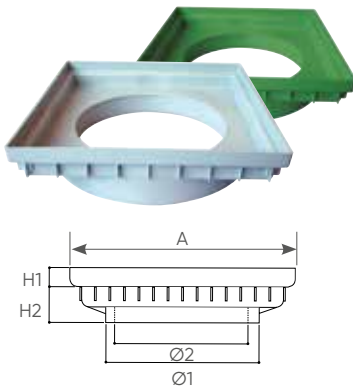

Dim A (mm)	Ref.			Ø1 (mm)	Ø2 (mm)	H1 (mm)	H2 (mm)	Colour	Note
450x450	ETTQ304	1	40	400	315	50	65	Grey RAL 7035	Compatible with pedestrian and light traffic 450x450 covers and grills
450x450	ETTQ30V*	1	40	400	315	50	65	Green RAL 6005	Compatible with pedestrian and light traffic 450x450 covers and grills

*upon request

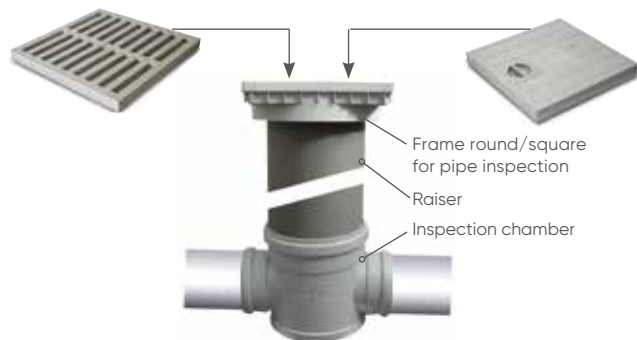
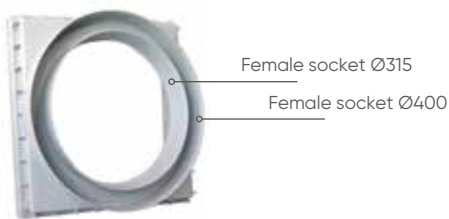



Frame
Cadre - Cerco

⌀ Dim (mm)	Reference Grey Ral 7035	Reference Green Ral 6005			A (mm)	B (mm)	C (mm)	H (mm)	Material
200x200	E202004	E20200V	10	400	200	160	209	40	PVC
300x300	E203004	E20300V	5	165	300	250	328	42	PVC
350x350	E203504	E20350V	5	120	350	300	352	42	PVC
400x400	E204004	E20400V	2	64	400	350	428	45	PVC
450x450	E204504	E20450V	2	64	450	400	448	45	PVC
550x550*	E205604	E20560V	1	40	550	500	583	55	*PP

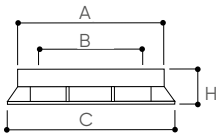

Material: PVC

Use: to house covers, grates and formworks for closing concrete or masonry catch basins or for other special applications.

Installation: thanks to its special side slits, the REDI frame perfectly fits concrete.

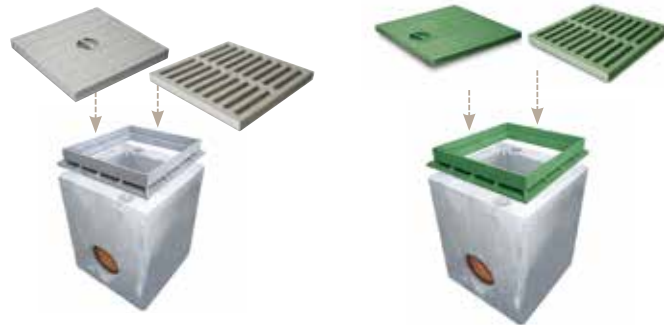

PVC Formwork with handle
Tampon de coffrage avec poignée et cadre en PVC
Tapa rellenable con asa y cerco PVC

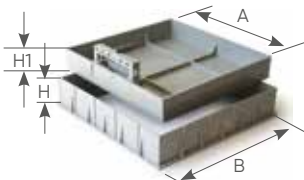

⌀ Dim (mm)	Reference Grey Ral 7035			A (mm)	H (mm)	B (mm)	H1 internal	Dim. Concrete catch basin	kg
350x350	ECM3504	1	78	350x350	70	370x370	50	300x300	2,5
450x450	ECM4504	1	32	450x450	70	470x470	50	400x400	3,5
550x550	ECM5004	1	26	550x550	70	570x570	50	500x500	4,8



Material: PVC

Use: as an alternative to the normal cover for catch basin when the surface appearance has to be kept unaltered.

The cover's cavity has to be filled with the proper material (as shown in the pictures).

Once installed, it can be easily lifted off by the handle.

Application field: light duty traffic areas such as garage fronts, private driveways, parkings pedestrian areas.

Durability: PVC specifications and structure design give this product a great resistance against atmospheric agents and ageing, and ensure dimensional stability in time.

Benefits:

- Handle tested to resist (certified traction resistance of 220 kg)*
- Handle easily extractable (handle fixed with screws on the bottom of the formwork)
- Manageable and practical
- Handle fixed with screws on the bottom of the formwork so that it can be easily dismantled for cleaning
- Iron mesh can be placed inside to improve load resistance
- Designed to support heavy loads
- Thicker section to avoid lateral bendings
- Resistant to acids and atmospheric agents
- Certified load resistance (more than 203 kn = 20,3t)*

* Test have been carried out by Istituto Giordano. Data and specifications are available on request

PP Formwork

Tampon de coffrage en PP - Tapa rellenable PP

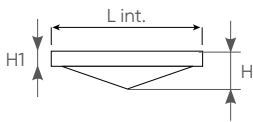

Dim (mm)	Reference Grey Ral 7035			L. int (mm)	H (mm)	H1 (mm)	Note
200 x 200	E292204	10	400	182	29	16	
300 x 300	E293304	5	165	278	41	19	
400 x 400	E294404	2	64	375	42	20	

Material: Polypropylene

Use: as an alternative cover for catch basin when the surface appearance has to be kept unaltered. The cover's cavity has to be filled with the proper material (as shown in the pictures).

Installation: the recessed cover perfectly fits the REDI catch basin. Always use a frame when closing concrete catch basins or in case of special applications.

Once installed, it can be easily lifted off by the central pin.

Application field: pedestrian area, bicycle paths.

Durability: as Polypropylene is a plastic corrosion proof material, the REDI recessed cover is the best alternative to metal products subject to deformation due to atmospheric agents and ageing.

Filling suggestions

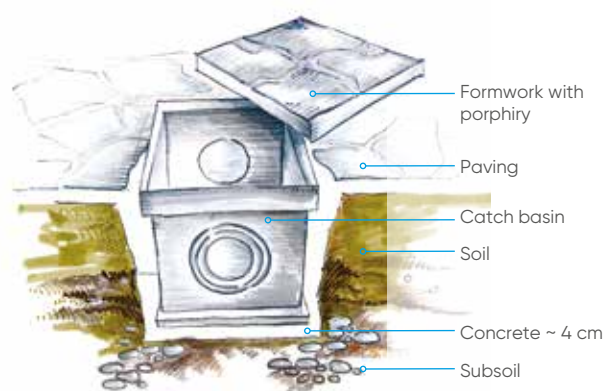
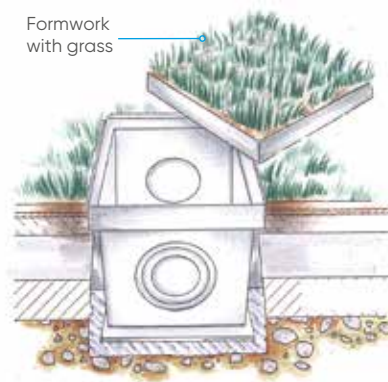

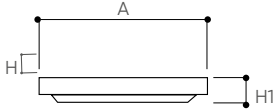

Pedestrian PVC grill (A15 load class)

Grille piétonnière en PVC - Rejilla peatonal PVC

Dim (mm)	Reference Grey Ral 7035			A (mm)	H (mm)	H1 (mm)			Note
200x200	E722004	10	950	187	20	25	25	1,7	
300x300	E723004	5	300	284	20	30	18	2,8	
400x400	E724004	2	156	383	25	35	19	3,8	
450x450	E724504*	2	64	432	25	40	22	4,1	
550x550	E725504	1	50	534	34	45	38	4,6	

Material: PVC

Colour: GREY RAL 7035

*upon request

Use: to cover rain or waste water drainage catch basin.

Installation: the grate perfectly fits the REDI catch pit.

Always use a frame when covering concrete catch basin or in case of special applications.

Application field: pedestrian, cycle or motorcycle areas.

Durability: PVC specifications and structure design give this product a great resistance against atmospheric agents and ageing and ensure dimensional stability in time.

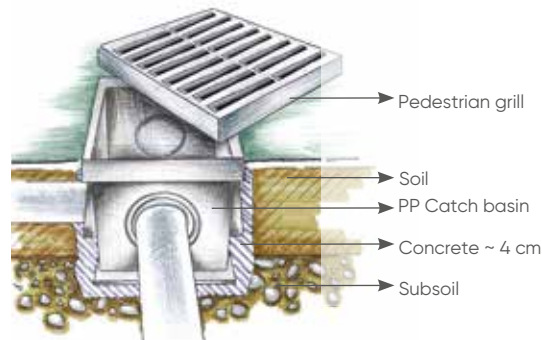

Heavy duty PVC grill (A15 load class)

Grille renforcée en PVC

Rejilla reforzada de PVC



Dim (mm)	Reference Grey Ral 7035			A (mm)	H (mm)	H1 (mm)			Note
200x200	E256704	10	400	187	20	35	49	1,7	
300x300	E256904	5	165	284	20	45	53	2,8	
350x350	E257004	5	120	331	22	45	84	3,3	
400x400	E257404	2	64	383	25	55	32	3,8	
450x450	E257504	2	64	432	25	55	63	4,1	
550x550	E257604	1	38	534	34	65	88	4,6	

Tested by ISTITUTO GIORDANO

Material: PVC

Colour: GREY RAL 7035

Use: to cover for rain or waste water drainage catch basin.

Installation: the grate perfectly fits the REDI catch pit.

Application field: light duty traffic areas, such as garage fronts, private driveways, pedestrian areas.

Durability: PVC specifications and structure design give this product a great resistance against atmospheric agents and ageing and ensure dimensional stability in time.

Pedestrian PVC cover (A15 load class)
Tampon piétonnier en PVC - Tapa peatonal PVC

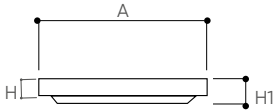

∅ Dim (mm)	Reference Grey Ral 7035			A (mm)	H (mm)	H (mm)		Note
200x200	E682004	10	950	187	20	25	14	
300x300	E683004	5	300	284	20	30	20	
400x400	E684004	2	156	383	25	35	25	
450x450	E684504	2	64	432	25	40	29	
550x550	E685504	1	50	539	34	45	26	

Material: PVC

Colour : GREY RAL 7035

Use: Catch pit covering.

Installation: the cover perfectly fits the REDI catch pit.

Application field: pedestrian, cycle or motorcycle areas. Durability: PVC specifications and structure design give this product a great resistance against atmospheric agents and ageing and ensure dimensional stability in time.

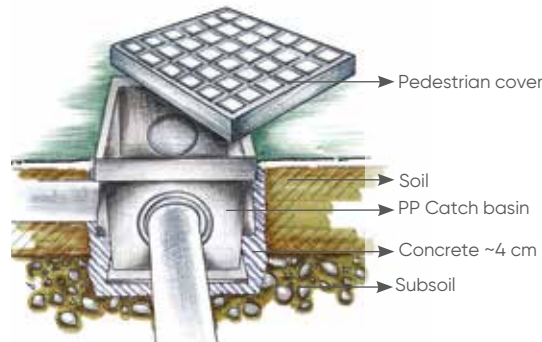

Heavy duty PVC cover (A15 load class)
Tampon renforcée en PVC
Tapa reforzada de PVC



∅ Dim (mm)	Reference Grey Ral 7035			A (mm)	H (mm)	H1 (mm)		Note
200x200	E255704	10	400	187	20	35	57	
300x300	E255904	5	165	284	20	45	35	
350x350	E256004	5	120	331	22	45	94	
400x400	E256404	2	64	383	25	55	31	
450x450	E256504	2	64	432	25	55	111	
550x550	E256604	1	38	534	34	65	56	

Material: PVC

Colour : GREY RAL 7035

Use: Catch pit covering.

Installation: the cover perfectly fits the REDI catch pit.

Application field: light duty traffic areas, such as garage fronts, private driveways, pedestrian areas.

Durability: PVC specifications and structure design give this product a great resistance against atmospheric agents and ageing and ensure dimensional stability in time.

Pedestrian green PVC grill (A15 load class)

Grille piétonnière en PVC - Rejilla peatonal PVC

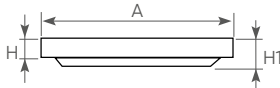

Dim (mm)	Reference Green Ral 6005			A (mm)	H (mm)	H1 (mm)			Note
200x200	E72200V	10	950	187	20	25	1,7	23	
300x300	E72300V	5	300	284	20	30	2,8	18	
350x350**	E25700V*	5	120	331	22	45	3,3	85	**Light traffic
400x400	E72400V	2	156	383	25	35	3,8	19	
450x450	E72450V*	2	64	432	25	40	4,1	22	
550x550	E72550V*	1	50	534	34	45	4,6	38	

*upon request

Pedestrian green PVC cover (A15 load class)

Tampon piétonnier en PVC - Tapa peatonal PVC

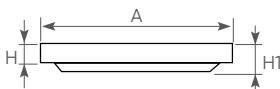

Dim (mm)	Reference Green Ral 6005			A (mm)	H (mm)	H1 (mm)		Note
200x200	E68200V	5	950	187	20	25	32	
300x300	E68300V	5	300	284	20	30	20	
350x350**	E25600V	2	120	284	22	30	85	**Light traffic
400x400	E68400V	2	156	383	25	35	26	
450x450	E68450V	1	64	432	25	40	27	
550x550	E68550V	1	50	534	34	45	21	

Pedestrian PVC cover with handle (A15 load class)

Tampon piétonnier avec poignée en PVC

Tapa peatonal con asa PVC

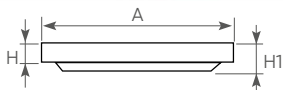

Dim (mm)	Reference Grey Ral 7035			A (mm)	H (mm)	H1 (mm)	H2 (mm)		Note
300x300	E255804	5	300	284	20	30	20	20	
400x400	E256304	2	156	383	25	35	26	26	
550x550	E257804	1	56	534	34	45	21	21	

Pedestrian green PVC cover with handle (A15 load class)

Tampon piétonnier avec poignée en PVC

Tapa peatonal con asa PVC

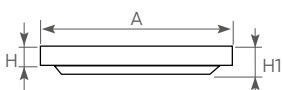

Dim (mm)	Reference Green Ral 6005			A (mm)	H (mm)	H1 (mm)		Note
300x300	E25580V	5	300	284	20	30	20	
400x400	E25630V	2	156	383	25	35	26	
550x550	E25780V	1	56	534	34	45	21	

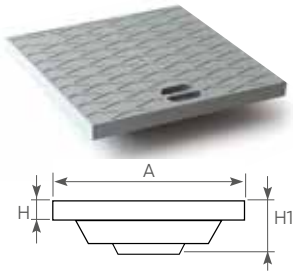

Light traffic PVC cover (B125 load class)

Tampon renforcé classe en PVC

Tapa reforzada de PVC

Dim (mm)	Reference Grey Ral 7035			A (mm)	H (mm)	H1 (mm)	KN	Note
300x300	ECR3004	2	120	284	20	67	>125	
400x400	ECR4004	2	64	383	25	62	>125	

Tested by ISTITUTO GIORDANO

LIGHT DUTY TRAFFIC
Load Class B125 in according with regulation EN 124



Light traffic PVC grill (B125 load class)

Grille renforcée en PVC

Rejilla reforzada de PVC

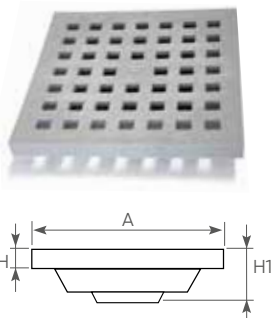

Dim (mm)	Reference Grey Ral 7035			A (mm)	H (mm)	H1 (mm)	KN	L/S	Note
300x300	EGR3004	2	120	284	20	67	>125	1,4	
400x400	EGR4004	2	64	383	25	62	>125	2,9	

Tested by ISTITUTO GIORDANO

LIGHT DUTY TRAFFIC
Load Class B125 in according with regulation EN 124

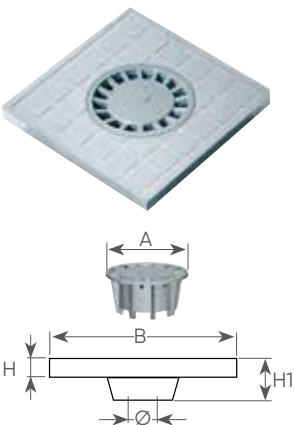

Pedestrian PVC cover with siphon

Tampon piétonnier avec siphon en PVC

Tapa peatonal con sifón PVC

Dim (mm)	Reference Grey Ral 7035			A (mm)	B (mm)	H (mm)	H1 (mm)	Ø (mm)	L/S	Note
300x300	ECN3004*	2	120	130	284	20	60	50	0,9	
400x400	ECN4004	1	32	180	383	25	83	75	1,4	

Use: to close inspection catch basins. Provided with a trap for rain or waste water drainage.

*upon request



PVC Valve box for irrigation

Bouche d'arrosage en PVC - Arqueta de riego con válvula PVC

∅ Dim (mm)	H (mm)	∅	Reference			Note
200x200	147	3/4"	W949400	1	100	

Material: PVC

Use: to connect irrigation hoses in gardens and pedestrian areas.

Features:

- easy-to-use built-in brass valve
- high resistance to mechanical stress
- high UV resistance
- hinged cover
- the box can be closed even if the hose is connected.

Note: it may be laid underground or fixed with concrete.

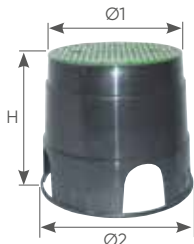
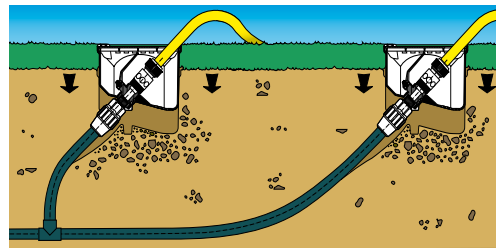
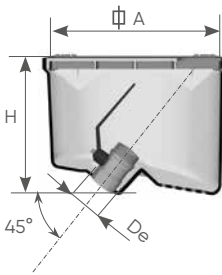

PP Bottomless valve box (round version)

Regard irrigation rond sans fond en PP

Arqueta de riego redonda PP

∅1 (mm)	∅2 (mm)	H (mm)	Reference			Note
160	212	230	POZ160V	1	320	
240	300	250	POZ240V	1	144	



PP Bottomless valve box (square version)

Regard irrigation rectangulaire sans fond en PP

Arqueta de riego rectangular PP

AxB (mm)	CxD (mm)	H (mm)	Reference			Note
380x510	260x385	300	POZ260V	1	32	
500x640	350x500	300	POZ500V	1	40	

Material: Polypropylene

Colour: Green cover and Black body

Use: this valve box allows irrigation systems connection and inspection in pedestrian areas.

Features:

- cover with screw fixing
- pierced walls for pipes to pass through.

Note: this valve box is self supporting. It may be laid underground or fixed with concrete.

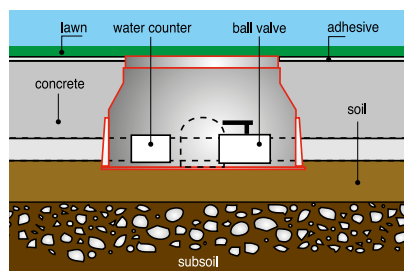
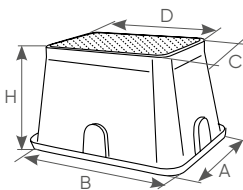

Rainwater Gullies

REDI



2.2 RAINWATER GULLIES

Rainwater Gullies



Installation example



Installation example

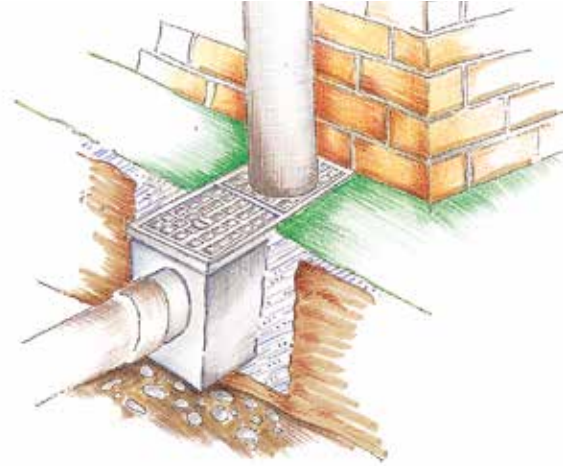

- Flow rate ex EN1253-1 § 8.11 (l/s)
- Flow rate measured on product (l/s)

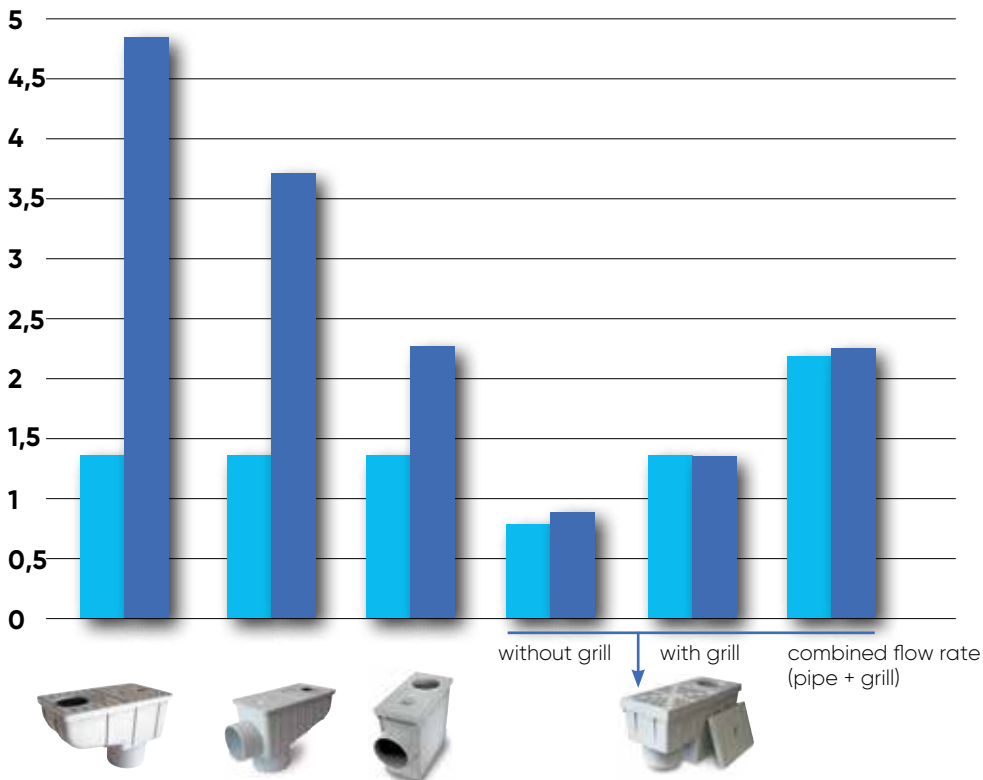

Untrapped rainwater gully with vertical/horizontal outlet

Regard de descente pour eaux pluviales sortie verticale/horizontale sans siphon - Arqueta para bajante de aguas pluviales, no sifónica, salida vertical/horizontal



Dim AxB (mm)	Reference Grey Ral 7035			Ø (mm)	Ø1 (inlets) (mm)	H (mm)		Material
166x300	Y891004	3	42	100/110	50/75/80/90/100/110/125	215	3,7	PP

Material: Polypropylene

Use: inspection chamber for rainwater flowing from gutter downpipes to the sewage.

Benefits:

ICE PREVENTION; light-weight; easier installation than concrete version; fully injection moulded; leaf guard to be positioned in horizontal or vertical direction; high durability in the long term; internal removable baffle plate; cover fasten to the gully or grill; available with round inlet Ø: 50/75/80/90/100/110/125; vertical and horizontal outlet Ø100 (internal) Ø110 (external); internal removable baffle plate; cover or grill fasten to the gully

Installation: a concrete floor seating is recommended.

Application field: pavements, grass or paved walkways.

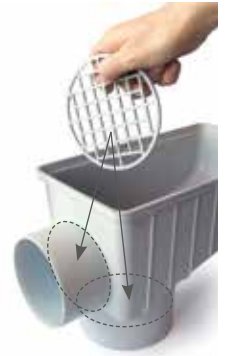
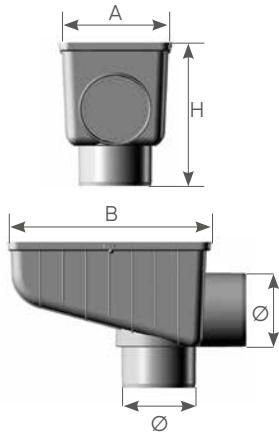

Untrapped rainwater gully with vertical outlet

Regard de descente pour eaux pluviales sortie verticale sans siphon - Arqueta para bajante de aguas pluviales, no sifónica, salida vertical

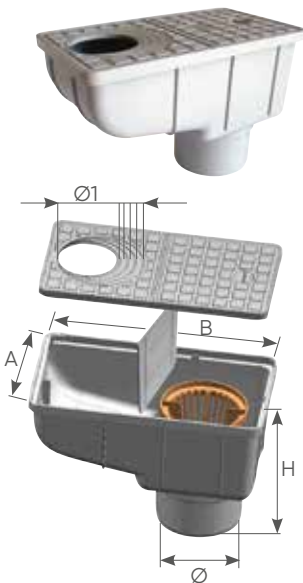

Dim AxB (mm)	Reference Grey Ral 7035			Ø (mm)	Ø1 (inlets) (mm)	H (mm)	C (mm)		Mat.
166x300	Y881004 ♦	6	84	100	50/75/80/90/100/110	195	80	4,9	PP
166x300	Y881104 ♦	6	84	110	50/75/80/90/100/110	195	80	4,9	PP

Tested by **CSTB**

♦ Available in BLACK and BROWN colours on request

Material: Polypropylene

Use: inspection chamber for rainwater flowing from gutter downpipes to the sewage.

Benefits:

ICE PREVENTION; light-weight; easier installation than concrete version; fully injection moulded; high durability in the long term; access cover with handle; leaves basket (except in model with Ø125 mm); internal removable baffle plate; available with round inlet Ø: 75/80/90/100/110; vertical outlet Ø100, Ø110 and Ø125

Installation: a concrete floor seating is recommended.

Application field: pavements, grass or paved walkways.

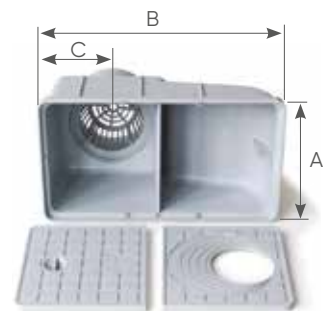

Easy to adapt



Supplied with basket



Trapped rainwater gully round inlet vertical outlet

Regard de descente avec siphon sortie verticale

Arqueta sifónica para bajante de aguas pluviales, salida vertical

Dim AxB (mm)	Reference Grey Ral 7035			Ø (mm)	Ø1 (mm)	Ø2 (mm)	H (mm)	 L/s	Material
380x156	Y661304 ◆	3	42	100	80	100	197	* 0,9 - 1,4	PP
380x156	Y662204 ◆	3	42	110	75/90	110	197	* 0,8 - 1,4	PP
380x156	Y663304 ◆	3	42	110	80	100	197	* 0,9 - 1,4	PP

Tested by **CSTB**

* Flow rate in accordance with regulation EN 1253-1 §8.11 (measured with and without grill)

◆ Available in BLACK colour on request

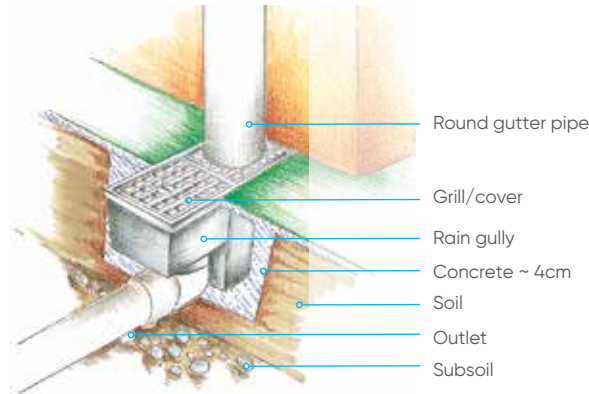
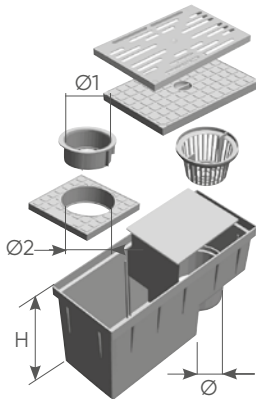

Material: Polypropylene

Use: trapped inspection chamber for rainwater flowing from gutter downpipes to the sewage.

Benefits: - light-weight

- easier installation than concrete version
- fully injection moulded
- high durability
- leaves basket
- Internal removable baffle plate
- available with round inlet Ø: 80/100 or Ø 75/90/110
- vertical outlet Ø 100 and Ø 110.

Installation: a concrete floor seating is recommended.

Application field: pavements, grass or paved walkways.

**Rainwater gully:
the right solution**

Existing solutions



Trapped rainwater gully with round inlet and horizontal outlet

Regard de descente avec siphon pour eaux pluviales entrée ronde sortie horizontale - Arqueta sifónica para bajante de aguas pluviales, salida horizontal

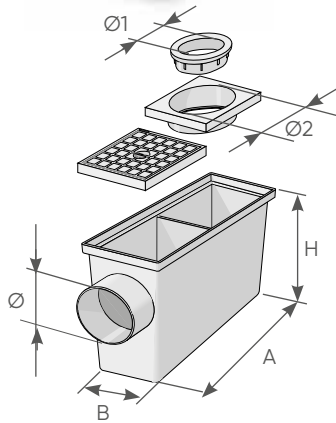

Dim AxB (mm)	Reference Grey Ral 7035			Ø (mm)	Ø1 (mm)	Ø2 (mm)	H (mm)		Material
240x128	Y661504	16	128	100	80	100	215	* 2,3	PP
240x128	Y662004	16	128	110	80	100	215	* 2,3	PP
240x128	Y661904	16	128	110	75	110	215	* 2,3	PP

Tested by **CSTB**

* Flow rate in accordance with regulation EN 1253-1 §8.11 (measured with and without grill)

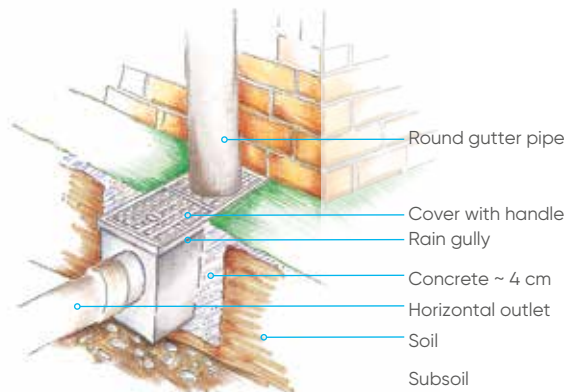

Trapped rainwater gully with square inlet and horizontal outlet

Regard de descente avec siphon pour eaux pluviales, entrée carrée sortie horizontale - Arqueta sifónica para bajante de aguas pluviales, salida horizontal

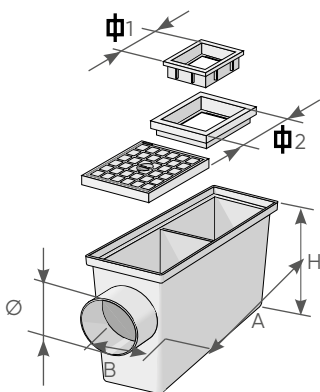

Dim AxB (mm)	Reference Grey Ral 7035			Ø (mm)	Ø1 (mm)	Ø2 (mm)	H (mm)		Material
240x128	Y771504	16	128	100	80	100	215	* 2,3	PP
240x128	Y772004	16	128	110	80	100	215	* 2,3	PP

Tested by **CSTB**

* Flow rate in accordance with regulation EN 1253-1 §8.11 (measured with and without grill)

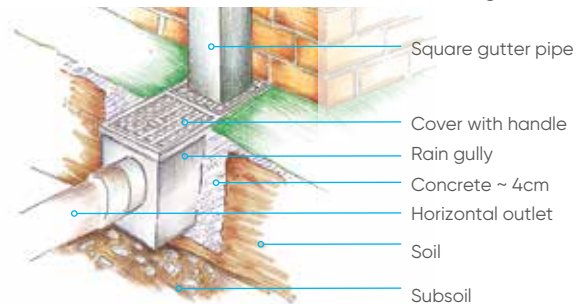

Material: Polypropylene

Use: inspection chamber for rainwater flowing from gutter downpipes to the sewage.

- Benefits:
- light-weight
 - easier installation than concrete version
 - fully injection moulded
 - high durability
 - access cover with handle
 - internal removable baffle plate
 - available with either square or round inlet
ROUND Ø 80/100 or Ø 75/110
SQUARE Ø 80/100
 - horizontal outlet Ø 100 and Ø 110.

Installation: a concrete floor seating is recommended.

Application field: pavements, grass or paved walkways.

Spare Parts - Pièces de rechang - Repuestos

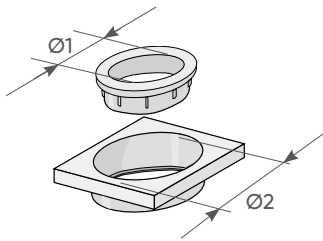

Round adaptor (horizontal outlet) Adapteur rond - Adaptador redondo

Ø1 (mm)	Ø2 (mm)	Reference Grey Ral 7035			Note
80	100	Y6688PO	20	1200	Two components
75	110	Y6677PO*	31	1.860	Two components

*upon request

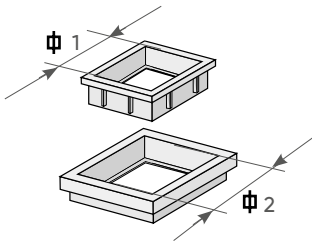

Square adaptor (horizontal outlet) Adapteur carré - Adaptador cuadrado

Ø1 (mm)	Ø2 (mm)	Reference Grey Ral 7035			Note
80	100	Y6666PQ	25	1.500	Two components

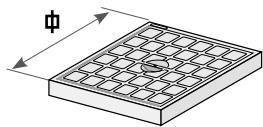

Cover Tampon - Tapa

Ø (mm)	Reference Grey Ral 7035			Note
118	Y665504	50	6.400	

Spare parts for untrapped rainwater gully Pièces de rechange pour eaux pluviales Repuestos para arqueta de aguas pluviales



Dim (mm)	Reference Grey Ral 7035			Note
146x160	NW29104*	1	3.456	Cover
146x160	NW73304	3	-	Cover with round inlet Ø: 50/75/80/90/100/110/125

*upon request

Modular Drainage Channels

REDI



2.3 MODULAR CHANNELS

Drainage channel installation instructions

In compliance with CE marking statement (Ex Reg. EN1433), it is compulsory to match a galvanized steel grill to the channel.



1
Excavate a trench 10 cms larger and 5 cms deeper than the channels you need to accommodate.



2
Butter the concrete on the bottom of the trench (as deep as the channel). No slope.



3
Use standard silicone glue for pasting the channels



4
Slot in the channel



5
Put the grills on the channels



6
Set down the channels and check that grill level and ground level are equal to each other



7
Pack with cement in order to eliminate air pockets. The channels must be set down with the grills. Put some shims between the grills and the edge of the channels: this will facilitate inspection by removing the grills, once installation is completed.

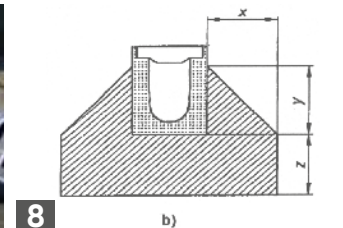

8
Use concrete class RCK 45. Load class according to the rule EN1433. The observance of the CE marking, according to EN1433, bind the grill 130 x 1000 to the channels 130 x 1000/52-70-90-130 internal height

Grill description	Channel dimensions*	Channel height*	Concrete RCK 450 (mm)			Trench dimensions (to be added to channel sizes mm)		
			X	Y	Z	Additional Side Dx	Additional Side Sx	Additional Depth
Swimming pool	130 x 500	70	33	68	42	100	100	50
High drainage	130 x 500	70	33	68	42	100	100	50
B125 grill	130 x 500	70	33	68	42	100	100	50
B125 cover	130 x 500	70	33	68	42	100	100	50
Swimming pool	130 x 500	134	33	134	42	100	100	50
High drainage	130 x 500	134	33	134	42	100	100	50
B125 grill	130 x 500	134	33	134	42	100	100	50
B125 cover	130 x 500	134	33	134	42	100	100	50
B125 grill	200 x 500	94	33	93	26	100	100	50
B125 cover	200 x 500	94	33	93	26	100	100	50
B125 grill	200 x 500	170	33	165	63	100	100	50
B125 cover	200 x 500	170	33	165	63	100	100	50
Galv. steel A15	130 x 1000	52	20	50	22	100	100	50
Galv. Steel B125 33*33	130 x 1000	52	50	60	50	100	100	50
Galv. Steel C250 33*33	130 x 1000	52	50	60	50	150	150	80
PP pedestrian grill	130 x 1000	70	33	74	66	100	100	50
Galv. steel A15	130 x 1000	70	33	74	36	100	100	50
Galv. Steel B125 33*33	130 x 1000	70	33	74	36	100	100	50
Galv. Steel C250 33*33	130 x 1000	70	70	74	70	150	150	80
Slot grill h. 85mm	130 x 1000	70	33	74	66	100	100	50
Galv. steel A15	130 x 1000	90	60	115	100	100	100	50
Galv. Steel B125 33*33	130 x 1000	90	60	115	100	100	100	50
Galv. Steel C250 33*33	130 x 1000	90	60	115	100	100	100	50
PP pedestrian grill	130 x 1000	130	33	136	40	100	100	50
Galv. steel A15	130 x 1000	130	33	136	40	100	100	50
Galv. Steel B125 33*33	130 x 1000	130	33	136	40	100	100	50
Galv. Steel C250 33*33	130 x 1000	130	70	136	70	150	150	80
Slot grill h. 85mm	130 x 1000	130	33	136	40	100	100	50

Slot Grill concealed drainage channel



Surface compatible with concrete application

Height compatible with all common materials

Male/Female connection

Marking:

Tested by



PP Slot grill 130x500

Grille fente 130x500 en PP - Rejilla ranurada 130x500 en PP

Dim (mm)	H int. (mm)	Dim slot (mm)	Reference				Note
130x500	85	8x49	EGF10PP	10	140	0,4	HIGH
130x500	20	8x49	EGFBAPP	10	360	0,4	LOW

Material: PP - Black colour

Slot grill can be installed in all drainage channels 130 with "C" section grate

KIT: 2 high slot grills with 1 PP channel 130x1000

Kit: 2 grilles fente hautes avec 1 caniveau en PP 130x1000

Kit: 2 Rejillas ranuradas altas con canaleta 130x1000 en PP

Dim (mm)	H1 (mm)	H2 (mm)	Dim. Slot (mm)	Reference			Note
130x1000	85	70	8x49	EGF15PP	1	55	2 slot grill 1 channel LOW
130x1000	85	130	8x49	EGF20PP	1	30	2 slot grill 1 channel HIGH

Material: PP - Black colour

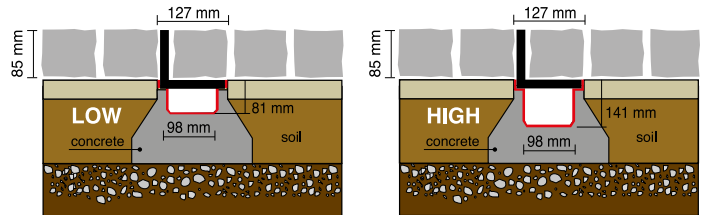
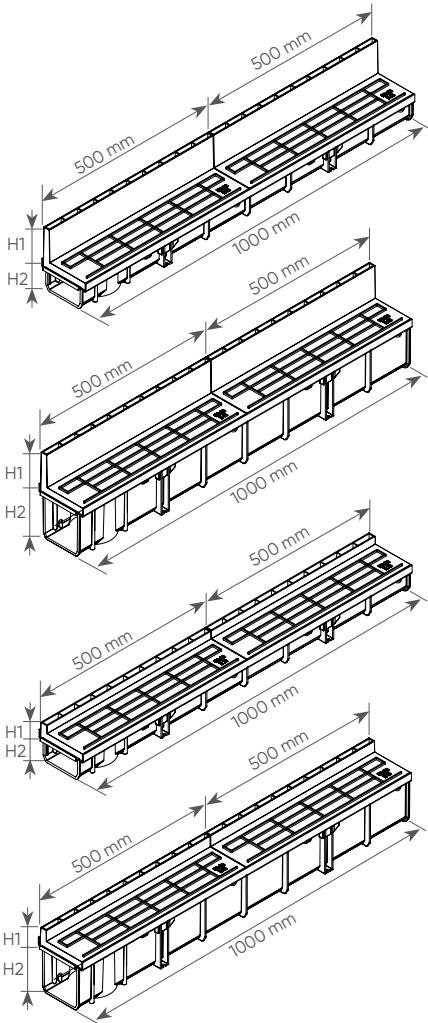

KIT: 2 LOW slot grills with 1 PP channel 130x1000

Kit: 2 grilles fente basses avec 1 caniveau en PP 130x1000

Kit: 2 Rejillas ranuradas bajas con canaleta 130x1000 en PP

Dim (mm)	H1 (mm)	H2 (mm)	Dim. Slot (mm)	Reference			Note
130x1000	20	70	8x49	EGFB5PP	1	56	2 slot grill 1 channel LOW
130x1000	20	130	8x49	EGFB0PP*	1	36	2 slot grill 1 channel HIGH

Material: PP - Black colour

*upon request

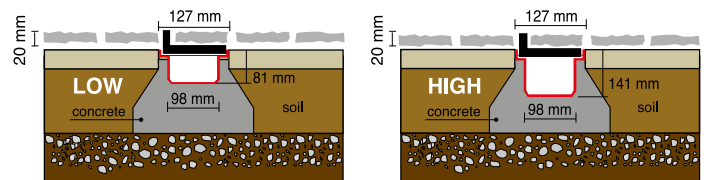

H130 "C" shaped profile



Note:
1 x vertical outlet predisposition (pag. 198)



Grate locking device applicable (pag. 198)



PP channel 130x1000 with "C" section grate Caniveau 130x1000 section "C" en PP avec grille Canal 130x1000 sección "C" en PP con rejilla

Type	Dim (mm)	H (mm)	Reference			Characteristic	Lock system
A	130x1000	130	ECAZNPP	1	60	Galvanized steel grill A15 EN1433	Lock system
B	130x1000	130	ECAIXPP*	1	60	Stainless steel grill	Lock system
C	130x1000	130	ECCZNPP	1	60	Galvanized steel grill, square mesh 33 x 33 mm B125 EN1433	Lock system
D	130x1000	130	ECCIXPP	1	60	PP black heel proof grill A15 EN1433	Predispose for locking system
E	130x1000	130	ECCPPOV*	1	30	Green RAL 6005 heel proof grill A15 EN1433	Predispose for locking system

Tested by "MASINI Research and Testing Institute"



*upon request

Marking: **CE**

Grating: class A15 EN1433. Use rain water drainage in pedestrian areas and light traffic areas.

Grate locking device applicable.

Grating: class B125 EN1433. Use rain water drainage. Especially designed for light duty traffic areas, such as garage fronts, private driverways, pedestrian areas. Grate locking device applicable.



E1712PP



E1714PP

PVC end cap outlet 130 Fond/naissance 130 en PVC - Tapón 130 con salida en PVC

Dim (mm)	H (mm)	Ø Outlet	Reference			Note
130	130	100	E1712PP*	10	600	
130	130	110*	E1714PP	10	600	*Offset

Material: PVC - Black colour

Use: end cap for 130 mm high channel. Easy-to-open outlet.

*upon request

Easy to open



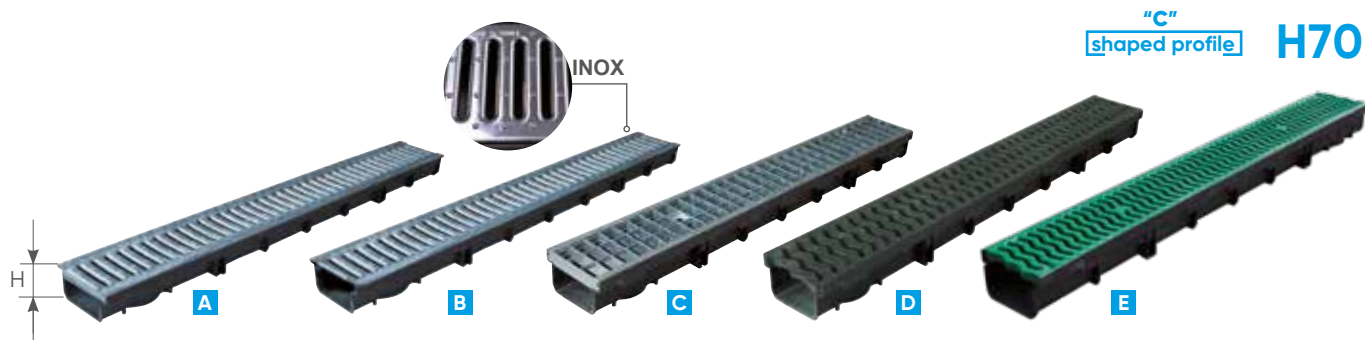

Note:
1 x vertical outlet
predisposition (pag. 198)



Grate locking device
applicable (pag. 198)



PP channel 130x1000 with "C" section grate
Caniveau 130x1000 section "C" en PP avec grille
Canal 130x1000 sección "C" en PP con rejilla

Type	Dim (mm)	H (mm)	Reference			Characteristic	Lock system
A	130x1000	70	ECBZNPP	1	105	Galvanized steel grill A15 EN1433	Lock system
B	130x1000	70	ECBIXPP	1	105	Stainless steel grill	Lock system
C	130x1000	70	ECDZNPP*	1	105	Galvanized steel grill, square mesh 33 x 33 mm B125 EN1433	Lock system
D	130x1000	70	ECDIXPP	1	105	PP Black heel proof grill A15 EN1433	Predispose for locking system
E	130x1000	70	ECDPPOV*	1	105	PP Green RAL 6005 heel proof grill A15 EN1433	Predispose for locking system

Tested by "MASINI Research and Testing Institute"



*upon request

Marking: **CE**

Grating: class A15 EN1433

Use: rain water drainage in pedestrian areas and light traffic areas. Grate locking device applicable.

Grating: class B125 EN1433

Use: rain water drainage. Especially designed for light duty traffic areas, such as garage fronts, private driverways, pedestrian areas. Grate locking device applicable.

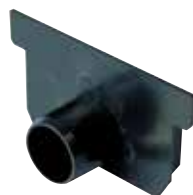

PVC end cap outlet 130
Fond/naissance 130 en PVC - Tapón 130 con salida en PVC

Dim (mm)	H (mm)	Ø Outlet	Reference			Note
130	70	50	E1718PP	10	1.280	

Material: PVC - Black colour

Use: end cap for 130 mm high channel. Easy-to-open outlet.



"T"
shaped profile **H52**

**Note:**

1 x vertical outlet
predisposition (pag. 198)

**PP channel 130x1000 with "T" section grate**

Caniveau bas 130x1000 section "T" en PP avec grille en acier galvanisé
Canal bajo 130x1000 sección "T" en PP con rejilla de acero galvanizado

Type	Dim (mm)	H (mm)	Reference			Characteristic	Lock system
A	130x1000	52	WCB13PP	1	105	Galvanized steel grill A15 EN1433	Interlock
B	130x1000	52	WCD13PP	1	105	Galvanized steel grill, square mesh 33 x 33 mm B125 EN1433	Free

Tested by "MASINI Research and Testing Institute"



*upon request

Marking: : **CE**

Grating: class A15 EN1433

Use: rain water drainage in pedestrian areas.



Grating: class B125 EN1433

Use: rain water drainage. Especially designed for light duty traffic areas, such as garage fronts, private driverways, pedestrian areas. Grate locking device not applicable.

PVC end cap outlet 130

Fond/naissance 130 en PVC - Tapón 130 con salida en PVC



Dim (mm)	H (mm)	Ø Outlet	Reference			Note
130	52	40	W6817PP	10	950	

Material: PVC - Black colour

Use: end cap for 130 mm high channel. Easy-to-open outlet.

H90 "T"
shaped profile



PP channel 130x1000 with "T" section grate (vertical outlet)
Caniveau 130x1000 section "T" en PP avec grille
Canal 130x1000 sección "T" en PP con rejilla (con salida vertical)

Type	Dim (mm)	H (mm)	Reference			Characteristic	Lock system
A	130x1000	90	WCA13PP	1	60	Galvanized steel grill A15 EN1433	Interlock

Tested by "MASINI Research and Testing Institute"

Marking: **CE**

Grating: class A15 - B125 - C250, EN1433

Use: rain water drainage. Especially designed for light duty traffic areas, such as garage fronts, private driver ways, pedestrian areas. Grate locking device not applicable.

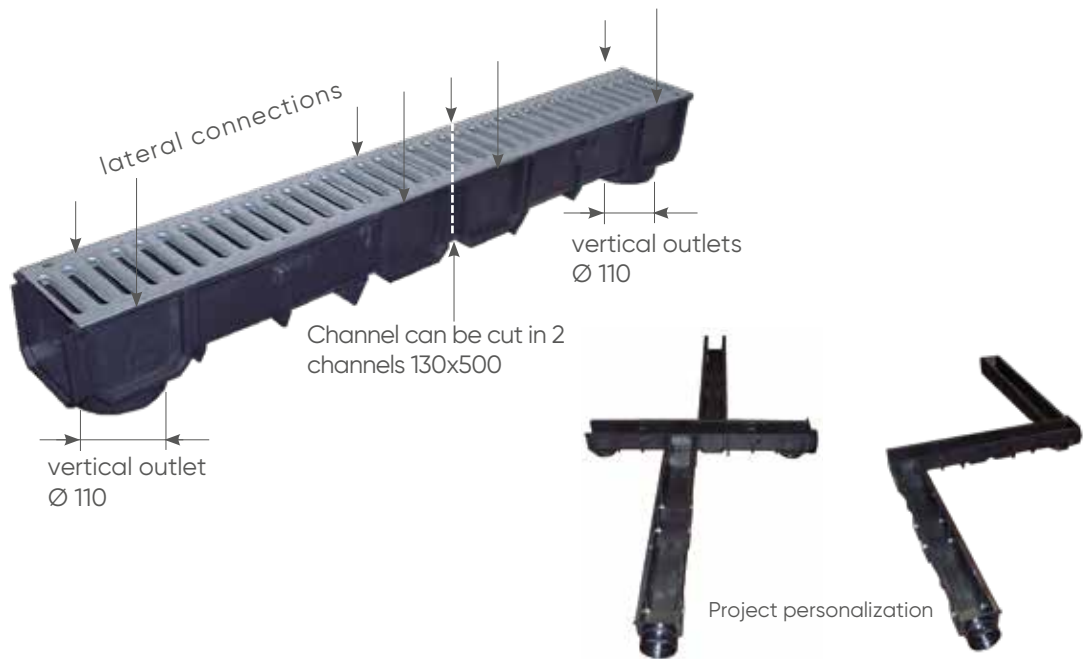

PVC end cap outlet 130
Fond/naissance 130 en PVC - Tapón 130 con salida en PVC

Dim (mm)	H (mm)	Ø Outlet (mm)	Reference			Characteristic
130	90	110*	W6816PP	10	-	*Offset

Material: PVC - Black colour

Use: end cap for 130 mm high channel. Easy-to-open outlet Ø110.



PVC Connector for vertical outlet 130

Piquages sortie verticale 130 en PVC - Conector para salida vertical

Dim (mm)	Ø (mm)	Reference			Note
130	100	EBU1008*	10	480	
130	110	EBU1108	10	520	

Material: PVC - Black colour

Use: Connector for vertical outlet Ø100 -110. With 4 fixing screw.

This item can be installed in all channels 130x1000.



*upon request

Grate locking device (with screw)

Fixation pour grilles - Bloqueo para rejilla (con tornillo)



Dim (mm)	Reference			Note
130x1000	W6820FX*	10	25.600	



*upon request

Universal leaf-guard

Crapaudine - Filtro atrapa hojas



Ø (mm)	Reference			Note
100-110	WGPAF00*	10	9000	

*upon request

Spare parts - Pièces de rechange - Repuestos

A15 Grill "C"- shaped profile

A15 Grille profil "C" - A15 rejilla sección "C"



Dim (mm)	H (mm)	Reference			Material	Note
130x1000	20	EGRZA15	1	100	Galvanized steel	"C" shaped profile
130x1000	20	EGRAA15	1	500	Stainless steel	"C" shaped profile

Note: The length of the metal grille is 997 ± 1m to avoid problems of linear expansion.

B125 Galvanized steel grill "C"- shaped profile

B125 Grille galvanisée profil "C"

B125 Rejilla acero galvanizado perfil "C"

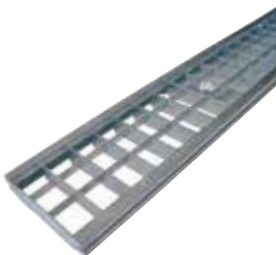

Dim (mm)	H (mm)	Reference			Note
130x1000	20	EGRB125	1	-	Square mesh 33 x 33 mm
200x1000	20	EG2B125*	1	-	Square mesh 33 x 33 mm

Note: The length of the metal grille is 997 ± 1m to avoid problems of linear expansion.

*upon request

C250 Galvanized steel grill "C" shaped profile

C250 Grille galvanisée profil "C"

C250 Rejilla acero galvanizado perfil "C"



Dim (mm)	H (mm)	Reference			Note
130x1000	20	EGRC250*	1	260	Square mesh 33 x 33 mm

Note: The length of the metal grille is 997 ± 1m to avoid problems of linear expansion.

*upon request

Easy installation of PVC sheet

Stainless steel modular grills and channels rails made of **STAINLESS STEEL AISI 304**

Strong anchorage to the concrete

Holes for water collection

Universal connection by gluing

ATTENTION: The channels must be set down with the grills. Put some shims between the grills and the edge of the channels: this will facilitate inspection by removing the grills, once installation is completed.

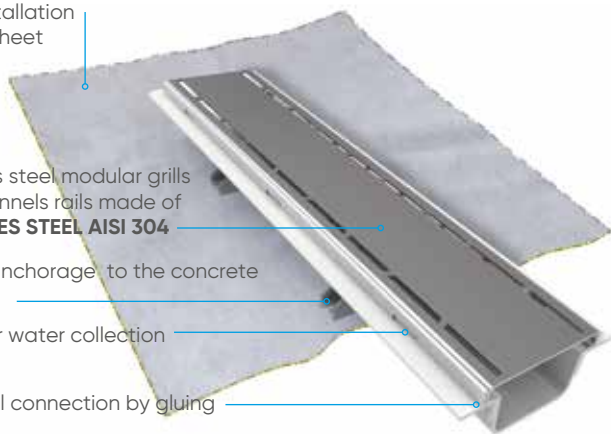

“Design” is a new range of non-trapped modular channels, with grates and channel rails made of stainless steel. Ideal for long stretches of drainage channel systems for white waters.

Thanks to the peculiar patterns engraved on the grills (laser technology), this product is particularly suitable for public showers, changing-rooms, gymnasiums and spas.

Characteristic:

- Modular PVC channel 100x500 mm.
- Height 50 mm.
- PVC outlet Ø 40 mm.
- PVC Universal corner 100x250 mm.
- Community design

Use solvent cement for PVC to weld the channels pag. 125



The “Design” grills can be classified in load class K3 in accordance with regulation **EN1253-2** (resistance >300 kg). All tests have been carried out at Aliaxis laboratories.

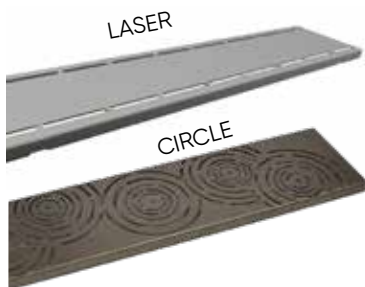

Grills 100 “Design” (stainless steel AISI 304)

Grille “Design” 100 (acier inoxydable AISI 304)

Rejilla “Design” 100 (acero inoxidable cromado AISI 304)

Dim (mm)	L/S	Reference			Design Type	Note
100x500	0,8	EZ10GLA*	1	100	LASER	
100x500	1,1	EZ10GCI	1	12	CIRCLE	

Material: Stainless steel AISI 304

*upon request

Low modular channel 100 (rails made of stainless steel AISI 304)

Corps de caniveau 100 (profilés en acier inoxydable AISI 304)

Canaleta baja 100 (rieles de acero inoxidable AISI 304)

L (mm)	L1 (mm)	L2 (mm)	H (mm)	H1 (mm)	Reference Grey Ral 7035			Note
100	500	96	50	12	EZ10CAI	12	168	Screwed stainless steel rails

Universal corner 100 with “Laser” design grill

Angle universel 100 avec grille design “Laser”

Ángulo canaleta 100 con rejilla de diseño “Laser”

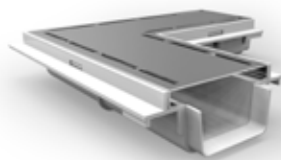

Dim (mm)	Reference Grey Ral 7035			Note
100x250	EZ10ALA*	1	120	Stainless steel AISI 304 grill

*upon request



Universal corner 100 with “Circle” design grill

Angle universel 100 avec grille design “Circle”

Ángulo canaleta 100 con rejilla de diseño “Circle”

Dim (mm)	Reference Grey Ral 7035			Note
100x250	EZ10ACI*	1	120	Stainless steel AISI 304 grill

*upon request

PVC Low modular channel 100

Corps de caniveau modulaire 100 bas en PVC Canaleta 100 de altura reducida en PVC

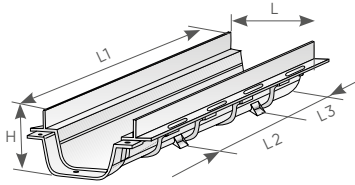

L (mm)	L1 (mm)	L2 (mm)	L3 (mm)	H (mm)	Reference Grey Ral 7035			Note
100	500	200	150	50	E1810B4	10	360	

Material: PVC

Use: rain water drainage in garages, terraces and balconies, multi-storeyed car parks in all cases of low concrete slab.

Features:

- Fixing brackets (preset for nails or screw fastening)
- Side slots for better anchorage to concrete
- Modular couplings by pins
- Preset for cover screw fastening
- Vertical outlet \varnothing 63 (easy perforation)
- End cap (outlet diameter 50)
- Possibility to glue the components to ensure water tightness.
- **Use solvent cement for PVC to weld the channels pag. 125**

Low modular channel 100 with vertical outlet \varnothing 63

Corps de caniveau modulaire 100 bas (sortie verticale \varnothing 63) Canaleta 100 de altura reducida en PVC (salida vertical \varnothing 63)

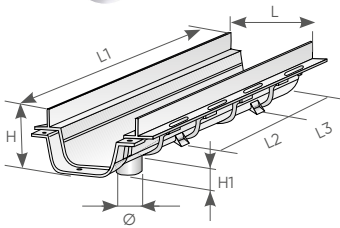

L (mm)	L1 (mm)	L2 (mm)	L3 (mm)	H (mm)	H1 (mm)	Ø (mm)	Reference Grey Ral 7035			Note
100	500	200	150	50	15	63	E1811B4	10	240	

Material: PVC

Use: rain water drainage in garages, terraces and balconies, multi-storeyed car parks in all cases of low concrete slab.

Features:

- Fixing brackets (preset for nails or screw fastening)
- Side slots for better anchorage to concrete
- Modular couplings by pins
- Preset for cover screw fastening
- Vertical outlet \varnothing 63 male (easy perforation)
- End cap (outlet diameter 50)
- Possibility to glue the components to ensure water tightness.
- **Use solvent cement for PVC to weld the channels pag. 125**

PVC Low universal corner channel 100

Angle universel corp de caniveau 100 bas en PVC Ángulo canaleta 100 de altura reducida en PVC

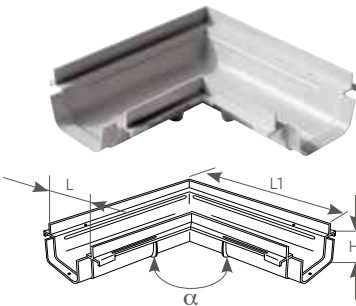

L (mm)	L1 (mm)	H (mm)	α	Reference Grey Ral 7035			Note
100	250	50	90°	E162504*	5	150	Universal - one piece moulded

Material: PVC

Use: rain water drainage in garages, terraces and balconies, multi-storeyed car parks in all cases of low concrete slab.

*upon request

PVC Low end cap-outlet 100

Fond/naissance 100 bas en PVC Tapón 100 de altura reducida con salida en PVC

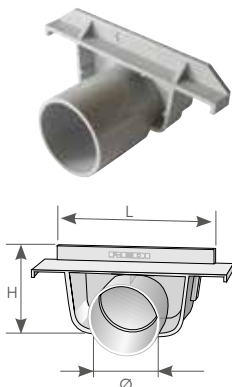



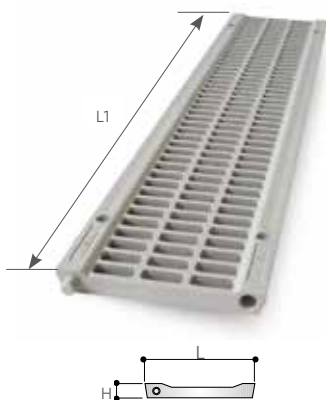

L (mm)	L1 (mm)	Ø (mm)	Reference Grey Ral 7035			Note
100	50	50*	E1710B4	10	1.280	*Offset

Material: PVC

Use: end cap for channel 100 (easy-to-open outlet).



PVC Universal pedestrian "heel-proof" grill 100
Grille piétonnière "anti-talon" 100 en PVC
Rejilla peatonal 100 en PVC

L (mm)	L1 (mm)	H (mm)	 L/S		Reference Grey Ral 7035			Note
100	500	12	2,3	>15	E2510B4	10	1.040	

Material: PVC

Use: pedestrian draining grating for 100 channels.



Features:

- heel proof for a safer tread
- antislip knurled surface and chamfered draining section to avoid backwater and icing
- provided with coupling pins
- preset for screw fastening to the channel.

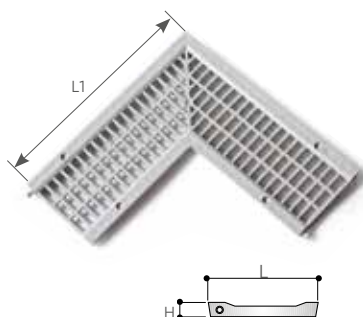
Durability: PVC specifications and structure design give this product a great resistance against atmospheric agents and ageing and ensure dimensional stability in time.



PVC Universal pedestrian "heel-proof" corner grating 100
Angle universel grille piétonnière "anti-talon" 100 en PVC
Ángulo rejilla peatonal 100 en PVC

L (mm)	L1 (mm)	H (mm)	α	Reference Grey Ral 7035			Note
100	250	12	90°	E721004*	5	300	Universal - one piece moulded

Material: PVC



Use: pedestrian draining grating for corner channels.

*upon request

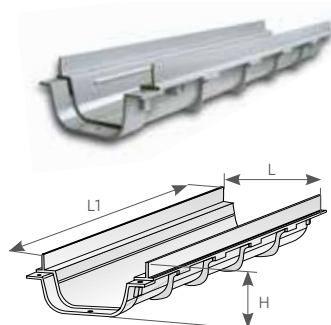
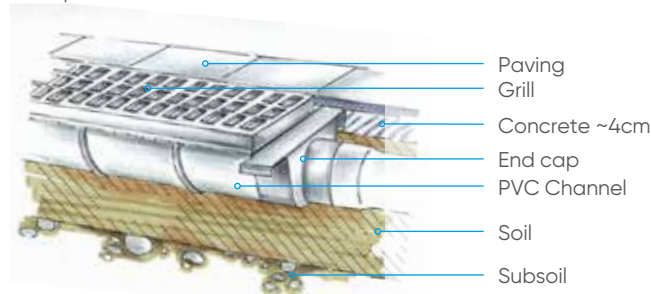
Examples of installation



PVC Low modular channel 130
Corp de caniveau modulaire 130 bas en PVC
Canaleta 130 de altura reducida en PVC

L (mm)	L1 (mm)	H (mm)	Reference Grey Ral 7035			Note
130	500	70	E1813B4	10	140	

Material: PVC

Marking: **CE**

Use: rain water drainage in garages, yards, terraces, balconies, multistoreyed parkings, and in all cases of low concrete slab.

Features:

- modular joint by pins
- preset for cover screw fastening
- possibility to glue the components to ensure water tightness.
- **Use solvent cement for PVC to weld the channels pag. 125**

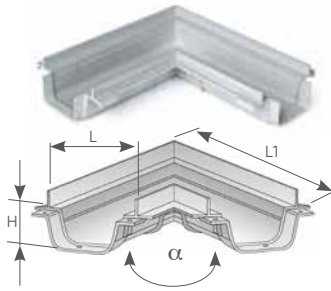

PVC Low universal corner channel 130

Angle universel corp de caniveau 130 bas en PVC
Ángulo canaleta 130 de altura reducida en PVC

L (mm)	L1 (mm)	H (mm)	α	Reference Grey Ral 7035			Note
130	250	70	90°	E731404	5	160	Universal - one piece moulded

Material: PVC

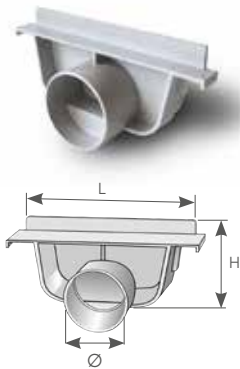

PVC Low end cap-outlet 130

Fond/naissance 130 bas en PVC

Tapón 130 de altura reducida con salida de PVC

L (mm)	L1 (mm)	Ø (mm)	Reference Grey Ral 7035			Note
130	67	40	E1713B4	10	950	

Material: PVC

Use: end cap for channel 130 (easy-to-open outlet).

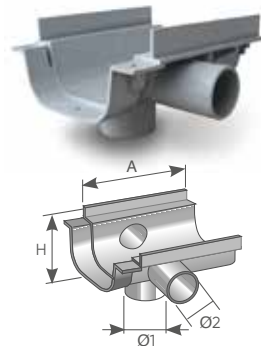

PVC Low junction channel 130

Naissance centrale 130 basse en PVC - Unión canaleta 130 de altura reducida y salida lateral/vertical en PVC

Ø1 (mm)	Ø2 (mm)	H (mm)	A (mm)	Reference Grey Ral 7035			Note
50	40	70	147	E1613B4	10	330	

Material: PVC

Use: Junction and drainage component for low channels 130 mm (easy-to-open outlet).

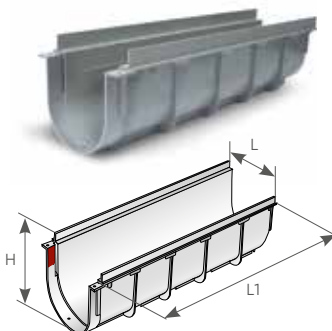

PVC High modular channel 130

Corps de caniveau modulaire 130 haut en PVC

Canaleta 130 alta en PVC

L (mm)	L1 (mm)	H (mm)	Reference Grey Ral 7035			Note
130	500	134	E1813A4	10	120	

Material: PVC

Marking: **CE**

Use: rain and waste water drainage in garages, yards, terraces, outdoor areas and public bathrooms and lavatories (gymnasium, etc).

Features:

- self supporting
- modular joint by pins
- possibility to glue the components to ensure water tightness
- a cover can be fastened by means of self-threading screw (pre-set holes).
- **Use solvent cement for PVC to weld the channels pag. 125**

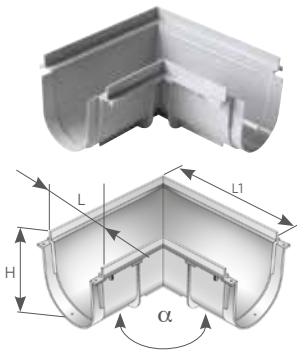

PVC Universal high corner channel 130
Angle universel de caniveau 130 haut en PVC
Ángulo canaleta 130 alta en PVC

L (mm)	L1 (mm)	H (mm)	α	Reference Grey Ral 7035			Note
130	250	134	90°	E731704*	5	80	Universal - one piece moulded

Material: PVC

*upon request

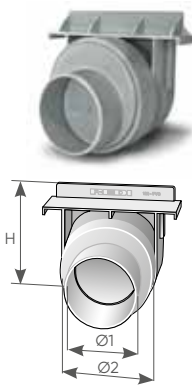

PVC high end cap-outlet 130
Fond/naissance 130 haut en PVC
Tapón 130 alto con salida en PVC

H (mm)	Ø1 (mm)	Ø2 (mm)	Reference Grey Ral 7035			Note
131	80	100	E1713A4	15	495	
131	75	110	E1711A4*	15	360	

Material: PVC

Use: end cap for high channel 130 (easy-to-open outlet).

*upon request

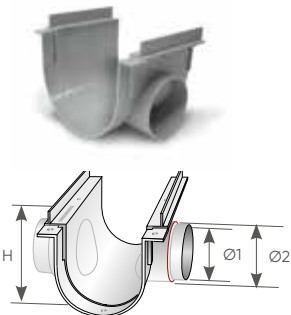

PVC High junction channel 130
Naissance centrale 130 haute en PVC
Unión canaleta con salida lateral 130 alta en PVC

H (mm)	Ø1 (mm)	Ø2 (mm)	Reference Grey Ral 7035			Note
134	75	80	E1613A4	10	120	

Material : PVC

Use: Junction and drainage component for high channels 130 mm (easy-to-open outlet).

Examples of installation

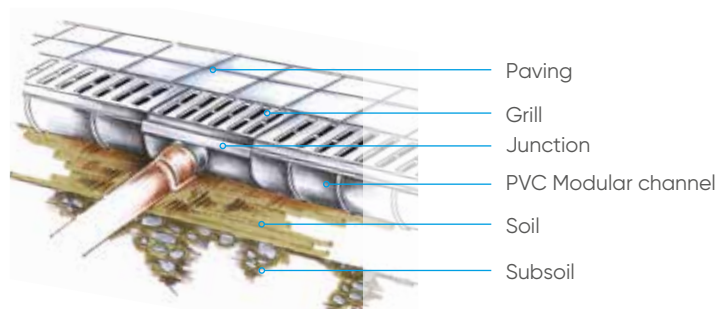

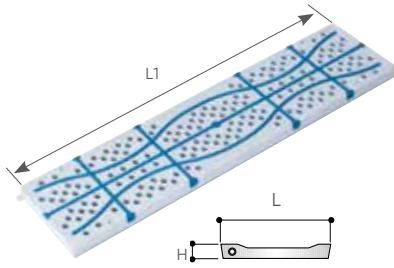

safeSTEP
by **REDI**

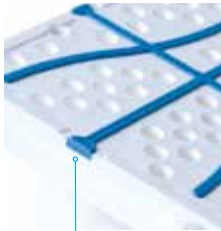

Anti slip
rubber

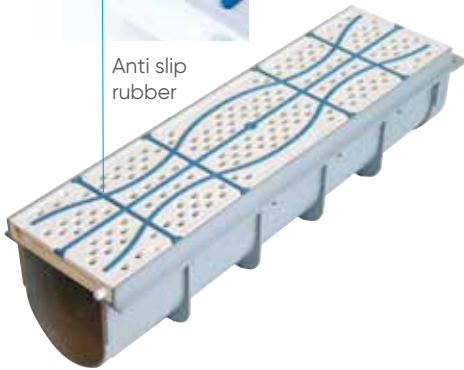

PVC Anti slip grill 130

Grilles pour piscine antidérapant 130 en PVC Rejilla peatonal antideslizante 130 en PVC

L (mm)	L1 (mm)	H (mm)	Reference			Colour	Note
130	500	20	0219503	10	420	White	
130	500	20	0219504	10	420	Grey	

Material: PVC

Colour: White RAL 9016 - Grey RAL 7035

Use: pedestrian draining cover for channels alongside swimming pools.

Excellent solution to prevent accidents due to slippery surface (also in laundries and other wet areas).

Italian design.

Corrosion-proof, maintenance-free reliable and lightweight.

No coating or extra treatment needed.

Safe Step grilles can be securely fixed onto Redi modular channels.

SAFESTEP means safety and design!



Examples of installation

PVC Walkaway grill standardized for swimming pools 130

Grilles pour piscine 130 en PVC Rejilla para piscina 130 en PVC

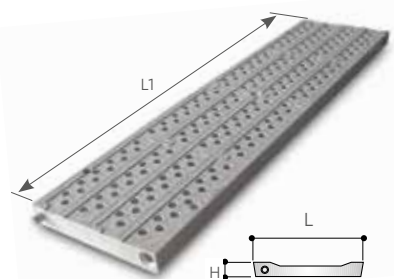

L (mm)	L1 (mm)	H (mm)	Reference				Colour	Note
130	500	20	W721503	10	420	1,2	White	
130	500	20	W721504	10	420	1,2	Grey	

Material: PVC - Colour: White RAL 9016 / Grey RAL 7035

Marking: **CE**

Regulation: **EN124 A15** Load class

Use: pedestrian draining cover for channels alongside swimming pools.

Features:

- Barefoot-friendly
- Antiskid knurled surface
- Provided with coupling pins
- Preset for screw fastening to the channel

Application field: pedestrian areas.

Durability: PVC specifications and structure design give this product a great resistance against atmospheric agents and ageing, and ensure dimensional stability in time.

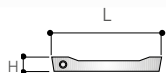
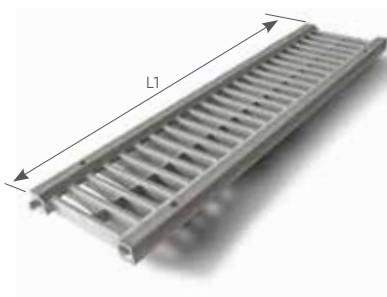

PVC High drainage grill 130
Grille piétonnière 130 en PVC
Rejilla peatonal 130 en PVC

L (mm)	L1 (mm)	H (mm)	Reference Grey Ral 7035			L/S	Note
130	500	20	E257704	10	420	3,6	

Material: PVC

Marking: **CE**

Regulation: **EN124 A15** Load class

Use: draining grate for 130 channels.

Features

- antiskid as the knurled surface and the chamfered draining profile avoid water stagnation and ice
- provided with coupling pins
- preset for screw fastening to the channel
- provided with a central stiffening rib.

Application field:

light duty traffic areas, such as garage fronts, private driveways, yards, pedestrian areas.

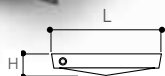
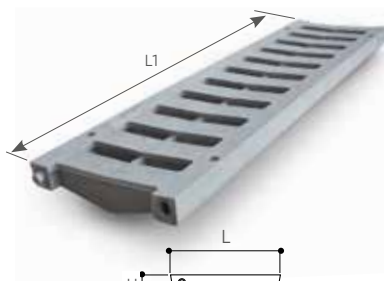

PVC Light traffic grill 130
Grille renforcée 130 en PVC - Rejilla reforzada 130 en PVC

L (mm)	L1 (mm)	H (mm)	Reference Grey Ral 7035			L/S	KN	Note
130	500	20	W672004	10	360	1,9	50	Class A15

Material: PVC

Marking: **CE**

Regulation: **EN124 A15** Load class

Use: draining light traffic cover for 130 channels.

Features:

- antiskid thanks to the knurled surface
- provided with coupling pins
- preset for screw fastening to the channel
- provided with a central stiffening rib.

Application field:

light duty traffic areas, such as garage fronts, private driveways, yards, pedestrian areas.

Important: in the planning stage, the grating breaking load must be scaled down by using a correct safety factor.

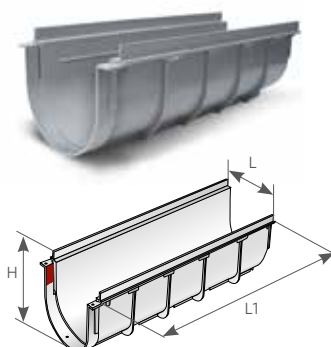

PVC High modular channel 200
Corps de caniveau modulaire 200 haut en PVC
Canaleta 200 alta en PVC

L (mm)	L1 (mm)	H (mm)	Reference Grey Ral 7035			Note
200	500	170	E1820A4	10	80	Class A15

Material: PVC

Marking: **CE**

Regulation: **EN124 A15** Load class

Use: rain and waste water drainage in garages, yards, terraces, balconies, other outdoor areas, public bathrooms and lavatories (gymnasiums, etc.).

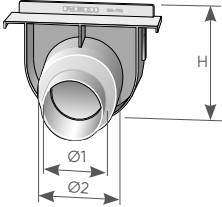

Features:

- self-supporting
- modular coupling by pins
- possibility to glue the components to ensure a higher water tightness
- a cover can be fastened by means of self-threading screws (preset holes)
- **Use solvent cement for PVC to weld the channels pag. 125**



PVC High version end cap-outlet 200

Fond naissance 200 haut en PVC
Tapón 200 alto con salida en PVC

L (mm)	H (mm)	Ø1 (mm)	Ø2 (mm)	Reference Grey Ral 7035			Note
200	170	80	100	E1720A4*	10	330	
200	170	75	110	E1722A4*	10	330	

Material: PVC

Use: end cap for high channels 200 (easy-to-open outlet).



*upon request

PVC Low modular channel 200

Caniveau 200 bas en PVC

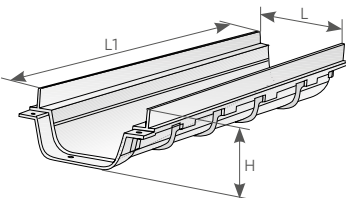
Canaleta 200 de altura reducida en PVC



L (mm)	L1 (mm)	H (mm)	Reference Grey Ral 7035			Note
200	500	94	E1821B4	10	120	Class A15

Material: PVC

Marking: **CE**

Use: rain water drainage in garages, yards, terraces, balconies, multi-storeyed car parks.



Features:

- self supporting
- modular coupling by pins
- possibility to glue the components to ensure a higher water tightness
- a cover can be fastened by means of self-threading screws (preset holes).
- **Use solvent cement for PVC to weld the channels pag. 125**

PVC Low modular channel 200

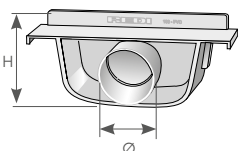
Caniveau 200 bas en PVC - Tapón 200 bajo con salida en PVC



L (mm)	L1 (mm)	Ø	Reference Grey Ral 7035			Note
200	97	75	E1719B4*	10	300	
200	97	80	E1721B4*	10	300	

Material: PVC

Use: end cap for low channel 200 (easy-to-open outlet).

*upon request

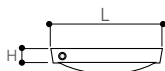

PVC Light traffic grill 200

Grille renforcée 200 en PVC - Rejilla reforzada 200 en PVC

L (mm)	L1 (mm)	H (mm)	Reference Grey Ral 7035					Colour	Note
200	500	20	0219004	10	140	L/S 2,8	61	Grey	Class A15

Material: PVC - Colour: White RAL 9016 - Grey RAL 7035

Marking: **CE**

Regulation: **EN124 A15** Load class

Use: light duty traffic draining grate for 200 channels

Characteristic:

- antiskid as the knurled surface and the chamfered draining profile avoid water stagnation and ice
- provided with coupling pins
- provided with a central stiffening rib.

Application field:

light duty traffic areas, such as garage fronts, private driveways, yards, pedestrian areas.

IMPORTANT: in the planning stage, the grate breaking load must be scaled down by using a correct safety factor.

PVC Frame for light traffic covers and grates 200

Cadre modulaire pour caniveau 200 en PVC

Cerco para canaleta 200 en PVC

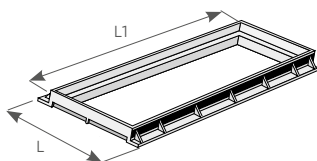

L (mm)	L1 (mm)	Reference Grey Ral 7035			Note
200	500	E250504	10	120	Modular

Material: PVC

Use: to house grates or covers for closing concrete channels or other special applications.

Floor Drains

REDI



2.4 FLOOR DRAINS

Floor Drains: the best solution for all drainage applications

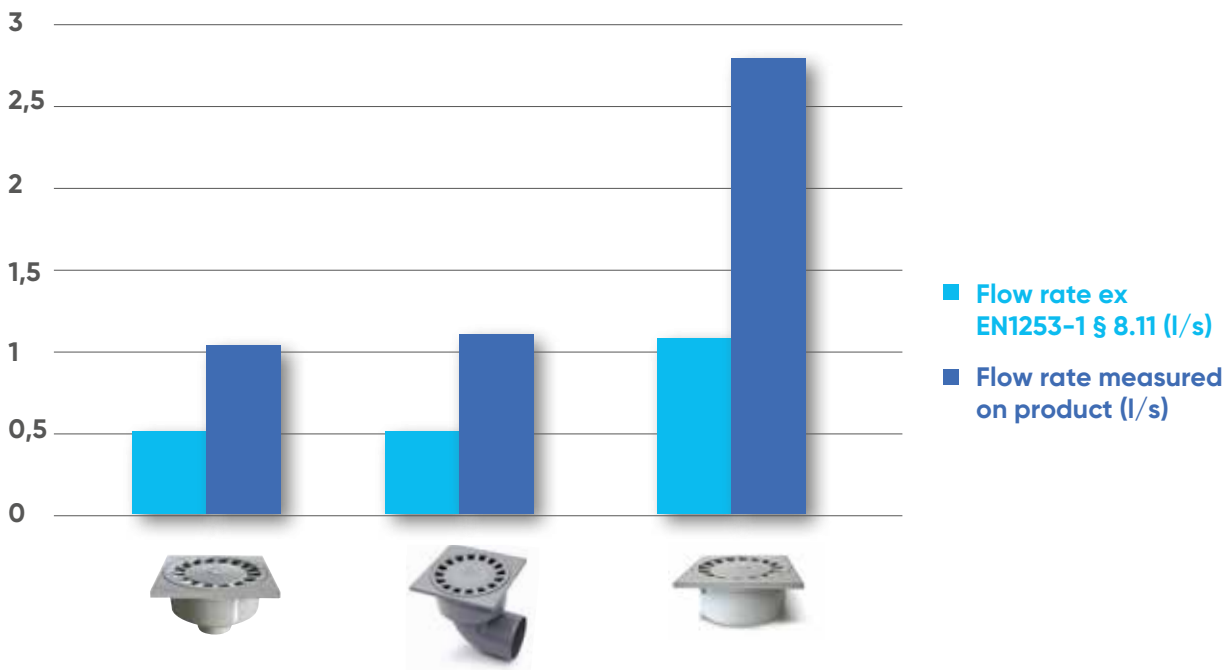
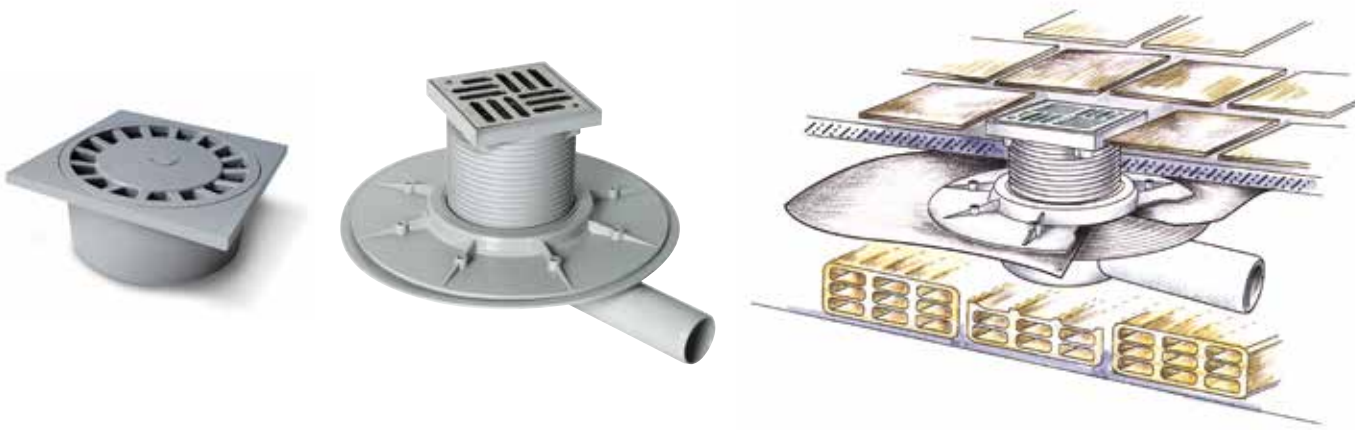

REDI products performances are proved and certified by strict laboratory tests.

Tests for defining the drainage flow rate: carried out in compliance to EN 1253-1 norm, par. 8.11. In this catalogue's "Products" section, the drainage flow rate is expressed in liters per second the symbol:



Discharge capacity test

IT WORKS EVEN WITHOUT WATER!

The dry trap prevents any bad smell even without water seal. For rain and waste water collection. Especially designed for balconies, terraces and in all cases of low concrete slabs.

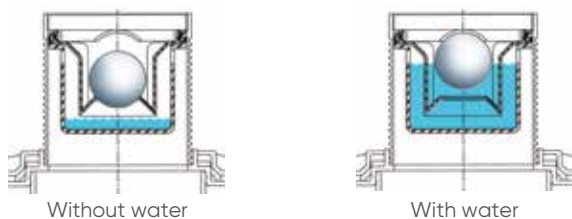

Advantages:

- Low casing to fit small spaces.
- Round plate and flange to lock the insulating membrane.
- 360° adjustable riser and PVC body.
- Easy inspection.
- Vertical outlet.
- Slotted PP or stainless steel grill dims.100x100, 150x150 available.
- Fastening screws are supplied with all stainless steel grilles (included in the package).



The trap may be easily removed for cleaning



Example of installation with insulating membrane

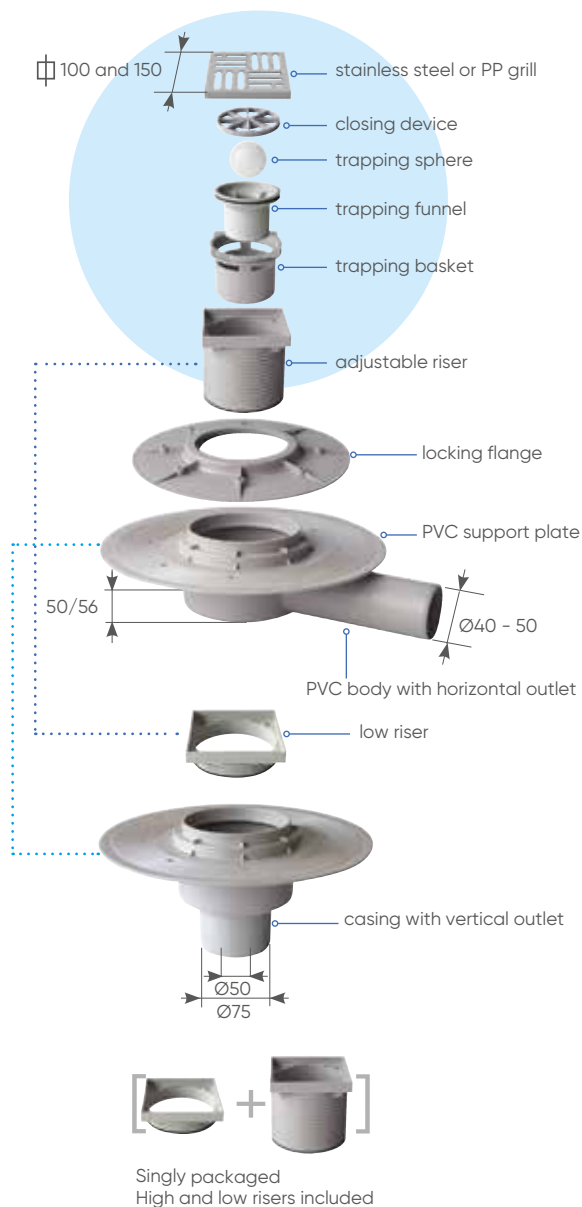

Dry floor trap with horizontal outlet can be connected by gluing or by push fit.

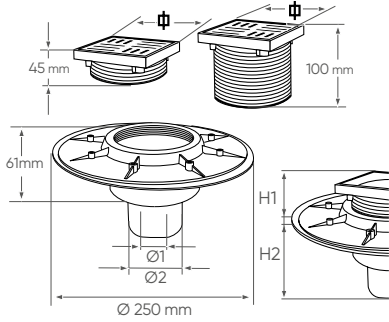
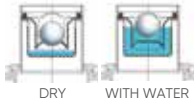

PVC Dry floor trap with vertical outlet
Siphon en PVC de cour-sortie verticale
Sumidero sifónico seco en PVC, salida vertical

Ø	Reference Grey Ral 7035			Ø1 (mm)	Ø2 (mm)	H (mm)	H1 min. (mm)	H2 (mm)	 l/s	Note
100	EAS35AI	1	60	50	75	61	45	115	< 0,6	Stainless steel AISI 304 grill
150	EAS45AI	1	60	50	75	61	61	115	< 0,6	Stainless steel AISI 304 grill



All products can be classified in load class K3 in accordance with regulation **EN1253** (resistance >300 kg). All tests have been carried out at Aliaxis laboratories. Supplied with protection to permit easy installation.

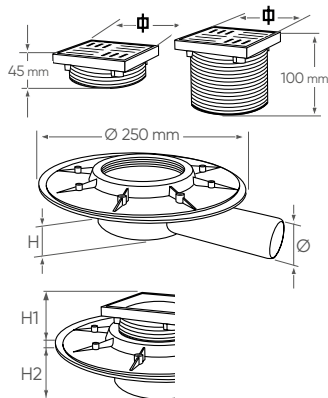
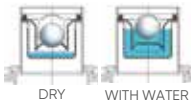
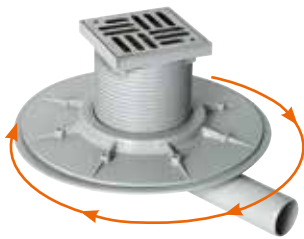

PVC Dry floor trap with horizontal outlet
Siphon de cour-sortie horizontale
Sumidero sifónico seco en PVC, salida horizontal

Ø	Reference Grey Ral 7035			Ø1 (mm)	H (mm)	H1 min. (mm)	H2 (mm)	 l/s	Note
100	EAS14AI	1	60	40	50	45	47	< 0,6	Stainless steel AISI 304 grill
100	EAS14PP	1	60	40	50	45	47	< 0,6	PP Grill
150	EAS24AI	1	60	40	50	45	47	< 0,6	Stainless steel AISI304 grill
150	EAS24PP	1	60	40	50	45	47	< 0,6	PP Grill
100	EAS15AI	1	60	50	56	45	60	< 0,6	Stainless steel AISI304 grill
100	EAS15PP	1	60	50	56	45	60	< 0,6	PP Grill
150	EAS25AI	1	60	50	56	45	60	< 0,6	Stainless steel AISI304 grill
150	EAS25PP	1	60	50	56	45	60	< 0,6	PP Grill



All products can be classified in load class K3 in accordance with regulation **EN1253** (resistance >300 kg). All tests have been carried out at Aliaxis laboratories. Supplied with protection to permit easy installation.



PP Flexible floor drain

Siphon de cour flexible en PP - Sumidero encastrable en tuberías de bajantes pluviales, cuerpo en PP

Ø	Reference	Box	Pallet	Ø (mm)	H (mm)	K (mm)	I/s	Note
100	EFS10AI	1	162	100÷125	45÷110	13	0,4	Stainless steel AISI 304 grill "Dry trapping"
150	EFS15AI	1	162	100÷125	45÷110	13	0,4	Stainless steel AISI 304 grill "Dry trapping"



All products can be classified in load class K3 in accordance with regulation **EN1253** (resistance >300 kg). All tests have been carried out at Aliaxis laboratories. Supplied with protection to permit easy installation.



2.4 FLOOR DRAINS

PP Vertical outlet floor drain without trap

Receveur vertical non siphonné en PP

Sumidero en PP, no sifónico, salida vertical orientable

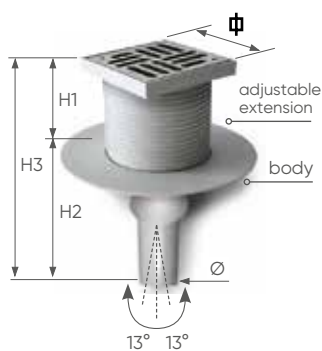

Ø	Reference	Box	Pallet	H1 (mm)	H2 (mm)	H3 min./max.	Ø (mm)	I/s	Note
100	E7810AI	6	138	100	165	179÷254	50	1,9	Stainless steel AISI 304 grill
150	E7815AI	6	96	100	165	179÷254	50	2,6	Stainless steel AISI 304 grill
100	E7810PP	6	138	100	165	179÷254	50	2,3	PP Grill
150	E7815PP	6	138	100	165	179÷254	50	2,5	PP Grill



All products can be classified in load class K3 in accordance with regulation **EN1253** (resistance >300 kg). All tests have been carried out at Aliaxis laboratories. Supplied with protection to permit easy installation.

Tested by **CSTB.fr**

Use: to collect rain and waste water. Especially designed for public premises, balconies, industrial kitchens, public lavatories and in all cases a trapping action is required.

Advantages: very low casing; round plate for membrane's heat sealing; 360° adjustable riser; easy inspection.

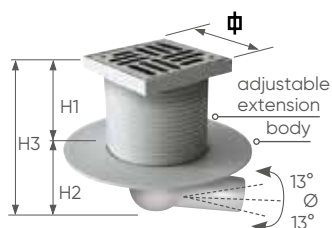

PP Horizontal outlet floor drain without trap

Receveur horizontal non siphonné en PP

Sumidero en PP, no sifónico, salida horizontal orientable

Ø	Reference	Box	Pallet	H1 (mm)	H2 (mm)	H3 min./max.	Ø (mm)	I/s	Note
100	E7910AI	6	138	100	95	128÷183	50	1,4	Stainless steel AISI 304 grill
150	E7915AI	6	138	100	95	128÷183	50	1,9	Stainless steel AISI 304 grill
100	E7910PP	6	138	100	95	128÷183	50	1,7	PP Grill
150	E7915PP	6	138	100	95	128÷183	50	1,8	PP Grill



All products can be classified in load class K3 in accordance with regulation **EN1253** (resistance >300 kg). All tests have been carried out at Aliaxis laboratories. Supplied with protection to permit easy installation.

Tested by **MPA.de**

PVC Floor drain (internal outlet)

Siphon de cour à emboîture incorporée en PVC

Sumidero sifónico de PVC con salida vertical interna

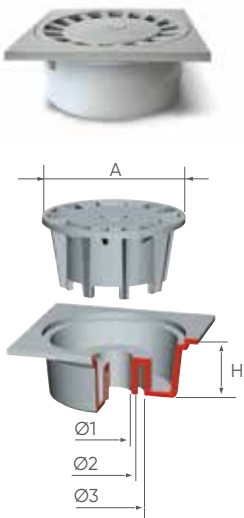

☐	Reference Grey Ral 7035			A (mm)	H (mm)	Ø1 (mm)	Ø2 (mm)	Ø3 (mm)				Note
									Ø1	Ø1	Ø1	
100	E191004	12	1.536	92	50	32	40	-	0,4	0,6	-	
150	E191504	12	360	138	63	40	50	63	0,7	0,8	0,8	
200	E192004	6	180	182	92	63	75	90	1,9	1,7	1,6	
200	E192504	6	180	182	92	63	75	100	1,9	1,6	1,6	
250	E192604	6	96	228	95	-	-	100	3,0	-	-	
300	E193004*	6	72	228	95	-	-	100	3,0	-	-	



All products can be classified in load class K3 in accordance with regulation **EN1253** (resistance >300 kg).
All tests have been carried out at Aliaxis laboratories.

Tested by **CSTB.fr**

*upon request

PVC Floor drain (external outlet)

Siphon de cour à sortie externe verticale en PVC

Sumidero sifónico de PVC con salida vertical externa

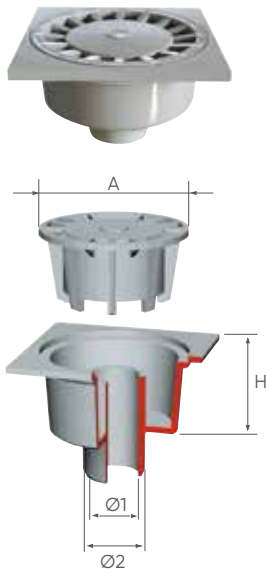

☐	Reference Grey Ral 7035			A (mm)	H (mm)	Ø1 (mm)	Ø2 (mm)		Note
								l/s	
100	0210804	18	936	92	50	32	40	0,89	
100	0210504*	18	936	92	50	-	50	1,0	
150	0211104	8	416	138	55	40	50	1,07	
200	0212204	8	192	177	65	63	75	1,34	
200	0212304	8	192	177	65	-	80	1,34	
200	0212404*	8	192	177	65	90	100	1,34	
200	0212504	8	192	177	65	100	110	1,34	
250	E220504*	6	96	177	83	-	110	1,6	
250	C221004*	6	96	177	83	-	100	1,6	
300	E222504	6	96	177	83	-	75	1,6	
300	E223004*	6	96	177	83	-	100	1,6	
300	E223504	6	96	177	83	-	110	1,6	



All products can be classified in load class K3 in accordance with regulation **EN1253** (resistance >300 kg).
All tests have been carried out at Aliaxis laboratories.

Tested by **CSTB.fr**

*upon request

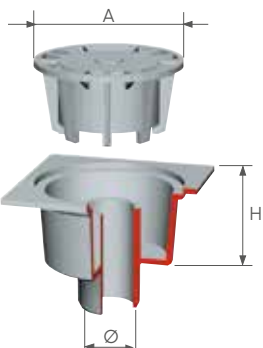

PP Floor drain (external outlet)

Siphon de cour à sortie externe vertical en PP

Sumidero sifónico de PP con salida vertical externa

⊘	Reference Grey Ral 7035			A (mm)	H (mm)	Ø (mm)	 I/S	Note
100	EP95604	12	720	92	61	50	0,8	
150	EP75804	12	384	92	59	50	-	
200	EP75904	12	276	92	65	50	-	
200	EP76004	6	138	177	83	75	1,6	
200	EP75104*	6	138	177	83	80	1,5	
200	EP76404	6	138	177	83	110	1,6	
250	EP76904	6	96	177	83	110	1,5	
300	EP77404*	6	96	177	83	110	1,5	



All products can be classified in load class K3 in accordance with regulation **EN1253** (resistance >300 kg). All tests have been carried out at Aliaxis laboratories.

Tested by **CSTB.fr**

*upon request

Material: Polypropylene

Use: to collect rain and waste water. Especially designed for public premises, balconies, industrial kitchens, public lavatories and in all cases a trapping action is required.

Advantages:

- easy inspection and cleaning
- internal, external and horizontal outlet versions available

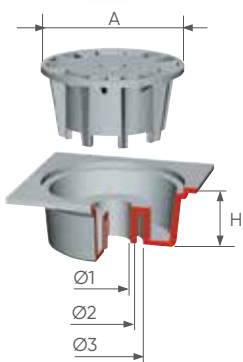

PP Floor drain (internal outlet)

Siphon de cour à emboîture incorporée en PP

Sumidero sifónico de PP con salida vertical interna

⊘	Reference Grey Ral 7035			A (mm)	H (mm)	Ø1 (mm)	Ø2 (mm)	Ø3 (mm)	 Ø1	 Ø1	 Ø1	Note
100	E195004	12	1.536	92	50	32	40	-	0,4	0,6	-	
150	E195504	12	360	138	63	40	50	-	0,7	0,8	0,8	
200	E196004	6	180	182	92	-	80	100	1,4	-	-	
250	E196204	6	96	228	95	-	100	-	3,0	-	-	
250	E196104	6	96	228	95	-	110	-	3,0	-	-	
300	E196304*	6	72	228	95	-	100	-	3,0	-	-	
300	E196404*	6	96	228	9	-	110	-	3,0	-	-	



All products can be classified in load class K3 in accordance with regulation **EN1253** (resistance >300 kg). All tests have been carried out at Aliaxis laboratories.

Tested by **CSTB.fr**

*upon request



PVC Floor drain 100 (horizontal outlet)

Siphonette 100 (sortie horizontale) en PVC

Sumidero sifónico, salida horizontal hembra de PVC

Ø	Reference			H (mm)	Øi (mm)	Øe (mm)		Note
100	0210304	16	832	82	32	40	-	
100	0210404	16	832	82	40	-	0,3	

Material: PVC

Use: to collect waste water especially designed for public premises, kitchens, public lavatories.
Application field: pedestrian areas.

Advantages:

- Easy cleaning and inspection thanks to the removable grill and trapping device.
- The square components may be rotated to fit floor's geometry.



ABS Chromium plated floor drain with vertical outlet

Siphon de cour chromé sortie verticale en ABS

Caldereta de piso cromada de ABS con salida vertical

Ø	Reference			H (mm)	Ø (mm)	Ø1 (mm)		Note
100	E2222CR	12	720	60	50	95	0,6	
150	E2233CR	12	384	60	50	95	<0,7	



All products can be classified in load class K3 in accordance with regulation **EN1253** (resistance >300 kg).
All tests have been carried out at Aliaxis laboratories.

Tested by **CSTB.fr**

Material: ABS - Colour: Chromium plated

Use: to collect waste water.

Especially designed for public premises, lavatories, and in all cases a trapping action is required.

The chromium plated material meets with the aesthetical requirements while granting the same water flowability of plastics materials. We suggested not to use aggressive chemical cleaners because in long term could damage chromium plating.

Advantages: easy inspection thanks to the removable trapping bell.

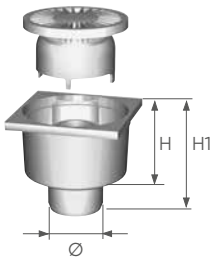



PP Trapped balcony floor drain with adjustable, horizontal outlet
Siphon de cour sortie horizontale et orientable en PP - Caldereta para terrazas y/o balcones con salida ajustable horizontal de PP

☐	Reference Grey Ral 7035			H (mm)	Ø (mm)	 l/s	Note
100	E224004	12	624	80	40	<0,6	PP Grill
100	E224504	12	624	80	50	<0,6	PP Grill
100	E2240AI	12	624	80	40	<0,6	Stainless steel AISI 304 grill
100	E2245AI	12	624	80	50	<0,6	Stainless steel AISI 304 grill

All products can be classified in load class K3 in accordance with regulation **EN1253** (resistance >300 kg). All tests have been carried out at Aliaxis laboratories.

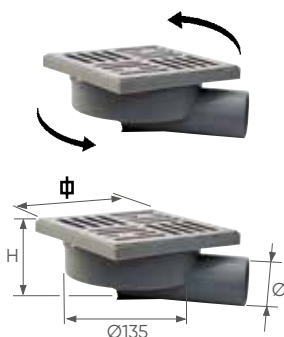

PP Trapped balcony floor drain with horizontal outlet, low version
Siphon de cour sortie horizontale et orientable en PP, version basse - Caldereta para terrazas y/o balcones con salida ajustable horizontal, versión baja

☐	Reference Grey Ral 7035			H (mm)	Ø (mm)	 l/s	Note
150	E224204	12	384	75	40	<0,6	PP Grill
150	E2242AI	12	384	75	40	<0,6	Stainless steel AISI 304 grill
150	E225004	12	384	75	50	<0,6	PP Grill
150	E2250AI	12	384	75	50	<0,6	Stainless steel AISI 304 grill

All products can be classified in load class K3 in accordance with regulation **EN1253** (resistance >300 kg). All tests have been carried out at Aliaxis laboratories.

Material: Polypropylene
 Use: to collect rain and waste water. Especially designed for balcony floor drain
 Advantages:
 - low casing
 - rotating grill
 - easy inspection

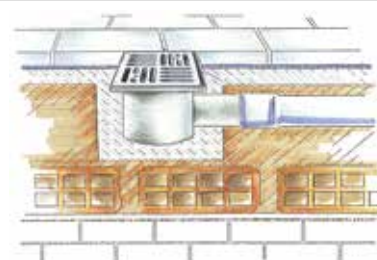

PP High capacity floor drain 1 outlet, low version
Siphon grand débit en PP, version bas
Caldereta de suelo gran caudal en PP, versión baja

☐	Reference Grey Ral 7035			Ø (mm)	H (mm)	 l/s	Note
150	EBA22AI	6	84	75	168	>1,05	Stainless steel AISI 304 grill
150	EBA44AI	6	84	110	168	>1,40	Stainless steel AISI 304 grill
150	EBA11PP	6	84	75	168	>1,14	PP Grill
150	EBA33PP	6	84	110	168	>1,41	PP Grill

All products can be classified in load class K3 in accordance with regulation **EN1253** (resistance >300 kg). All tests have been carried out at Aliaxis laboratories.



PP High capacity floor drain 1 outlet, high version

Siphon de terrasse grand débit en PP, version haut

Caldereta de suelo gran caudal en PP con altura ajustable, versión alta



Ø	Reference Grey Ral 7035			Ø (mm)	H1 (mm)	H2 (mm)	H min./max.		Note
150	EAL22AI	6	72	75	90	155	170÷245	>1,05	Stainless steel AISI 304 gril
150	EAL44AI	6	72	110	90	155	170÷245	>1,40	Stainless steel AISI 304 gril
150	EAL33PP	6	72	110	90	155	170÷245	>1,41	PP Grill



All products can be classified in load class K3 in accordance with regulation **EN1253** (resistance >300 kg). All tests have been carried out at Aliaxis laboratories.



Double flap anti-backflow device

Material: Polypropylene

Use: to collect rain or waste water in yards, garages cellars and any areas where a high drainage capacity is required.

Advantages:

- inspection basket
- 360° adjustable riser
- easy inspection
- an anti-backflow device can be fitted in to prevent back flooding.

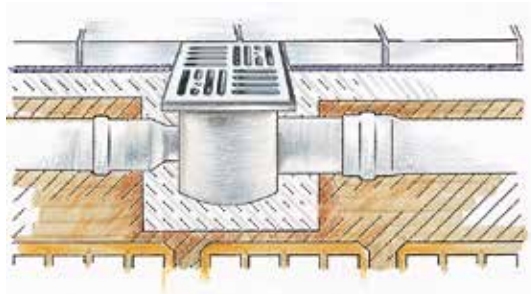

Example of assembly



Double flap anti-backflow device

Clapet anti-retour double - Valvula doble clapeta anti-retorno

DN (mm)	Reference Grey Ral 7035			Ø1 (mm)	Ø2 (mm)	Note
110	EDP1104*	6	768	70	103	

Material: Polypropylene

It may be fit in to high capacity floor drains to prevent back flooding.

*upon request

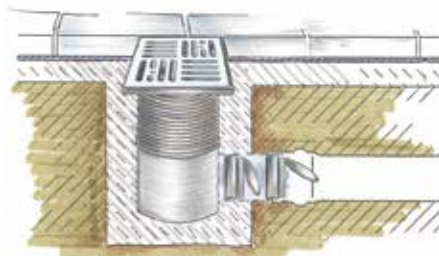
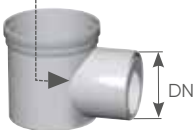

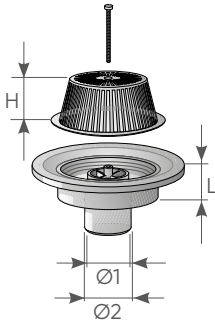

PVC roof outlet

Naissance pour eaux pluviales en PVC
Sumidero de PVC con rejilla alta

Ø1 (mm)	Ø2 (mm)	Reference Grey			I/s	H (mm)	L (mm)	Note
63	75	1992204	1	120	1,8	74	62	
	80	1992404*	1	120	1,8	74	62	
100	110	1992504	1	120	1,8	74	62	

*upon request

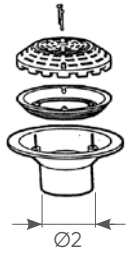

PVC Flat roof outlet

Naissance pour eaux pluviales en PVC
Sumidero de PVC con rejilla

Ø (mm)	Reference Grey			I/s	Note
160	H991604	7	56	4,0	



Universal leaf guard

Crapaudine - Filtro atrapa hojas

Ø (mm)	Reference			Note
60÷120	G456000	60	1.440	



Outlet union

Ø	Reference			A (mm)	B (mm)	C (mm)	D (mm)	H (mm)	Note
80	G400800	10	60	310	69	64	76	225	Material: Rubber Colour: Black
100	G401000	10	-	315	89	84	96	225	
125	G401200	8	-	319	114	109	121	225	



PVC Square hopper

Regard d'accès pluvial en PVC
Colector de agua pluvial en PVC

Ø	⊘	Reference Grey Ral 7035			I/s	Note
110	150	0076501	15	360	* 3,9	Red RAL 8023

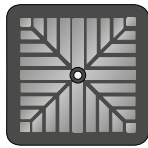

* Flow measured using the grid Reference 7302800



Grill for square hopper

Grille pour regard d'accès pluvial

Rejilla para colector de agua pluvial



DN (mm)	Reference			Note
150	7302800	50	3.200	

Spare parts - Pièces de rechang - Repuestos

PVC insulating membrane

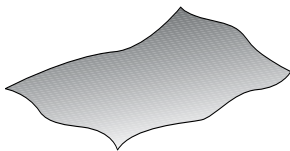
Membrane d'étanchéité - Lámina de PVC, impermeabilizante





DN (mm)	Reference			Note
1500 x 1500 x 0,8 mm	J022087	1	36	1 single sheet

Material: PVC plasticized - Colour: Grey - Use: waterproofing sheet

Stainless steel Grill

Grille en acier inox - Rejilla inoxidable





DN (mm)	Reference			Note
100	E9910AI	5	4.050	Stainless steel AISI 304
150	E9915AI	5	1.920	Stainless steel AISI 304
150	E9914AI*	1	1	Stainless steel AISI 316L (On request)

*upon request

PP Grill

Grille en PP - Rejilla PP



DN (mm)	Reference Grey Ral 7035			Note
150	E9915PP	5	1.920	Spare part for Ref. E224204 - E225504
100	E9910PP	5	4.050	Spare part for Ref. E224004 - E224504



Grill frame

Cadre pour grille - Cerco para rejilla

DN (mm)	Reference Grey Ral 7035			Note
150	E97BG00	20	1.620	Spare part for Ref. E224204 - E225504
100	E97BG10	50	4.050	Spare part for Ref. E224004 - E224504



Trapping funnel

Entonnoir de siphonnement - Campana para sifón

Ø1 (mm)	Ø2 (mm)	Reference Grey Ral 7035			Note
85	35	E97IM00	5	2.600	Spare part for Ref. E224004 - E224504 Spare part for Ref. E224004 - E224504



PP Trapped balcony floor drain with adjustable horizontal outlet
Siphon de cour en PP sortie horizontale et orientable
Reference: E225004 - E224204



PP Trapped balcony floor drain low with horizontal outlet
Siphon de cour en PP sortie horizontale et orientable bas
Reference: E224004 - E224504



Risers

Rallonges - Extensible con junta

DN (mm)	Reference Grey Ral 7035			Note
100	E98PRB0	1	-	Low riser
150	E99PRB0*	1	-	Low riser
100	E98PRA0	1	416	High riser
150	E99PRA0	5	360	High riser

*Available on demand, after feasibility check



Dry trap

Syphon à sec - Sifón seca

Reference			Note
KITC500*	1	1.200	Assembled trap (closing device + trapping+ trapping funnel + trapping basket)

*upon request

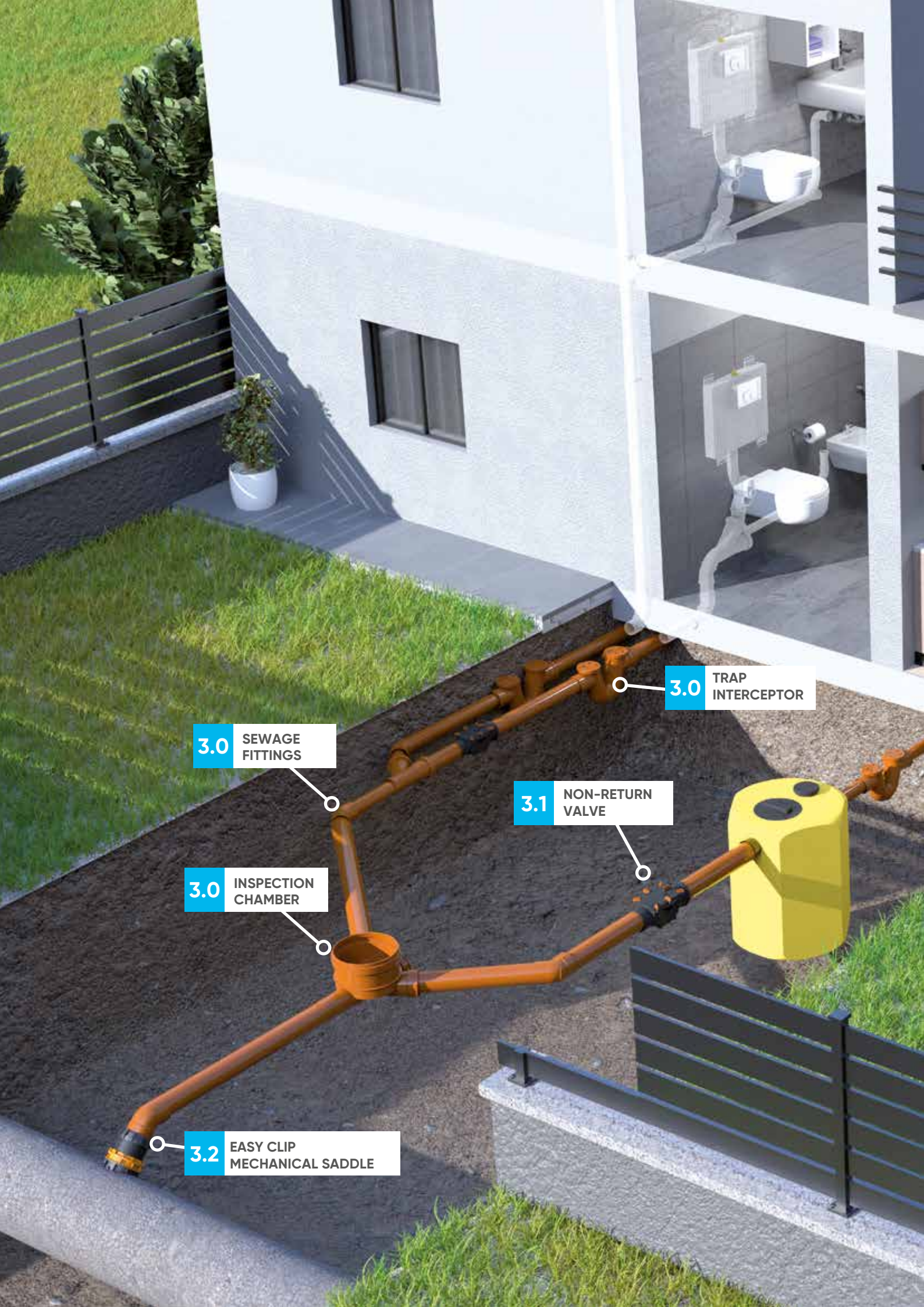

3.0 TRAP INTERCEPTOR

3.0 SEWAGE FITTINGS

3.1 NON-RETURN VALVE

3.0 INSPECTION CHAMBER

3.2 EASY CLIP MECHANICAL SADDLE



Underground Drainage and Sewage System

REDI



3.0 UGD & SEWAGE

EN 1401 Push-Fit PVC-U Fittings
PVC-U and PP Inspection Chambers
PVC-U Trap Interceptors

aliaxis

A complete range of fittings for underground drainage

Aliaxis offers a complete set of waste water drainage solutions starting from Phonoblack soundproof soil and waste system within the building structure (above ground drainage) up to the building-around system for non-pressure underground drainage and main public sewerage connections.

Aliaxis fittings and accessory equipments are completely certified by several European standards institutes, allowing the project design of drainage systems compliant to the local building regulations.

Aliaxis provides easy-to-install, strength and reliable solutions focused on building long-lasting systems installations.

Product specifications, technical data sheets, CAD drawings and updated certifications, technical are available on our website www.aliaxis.it

Certifications

- Sizes	EN1401
- Shock resistance	EN12061
- Mechanical stress resistance (Fabricated or thermoformed fittings)	EN12256
- Vicat softening temperature	EN727
- Heating effects	EN580
- Water tightness (Fabricated or thermoformed fittings)	EN1053
- Elastomeric sealing tightness* * (With diametrical elastic failure and angular bending under the following conditions +0,05 bar, +0,5 bar, -0,3 bar)	EN1277
- High temperature cycle	EN1055
- Pressure Strength	EN1167
- Lip Ring	EN 681

Installation tips

It is suggested to always chamfer the previously cut pipe and lubricate all plain ended spigots for an easily push-fit insert. All Ø110 fittings are SN8 – SDR34

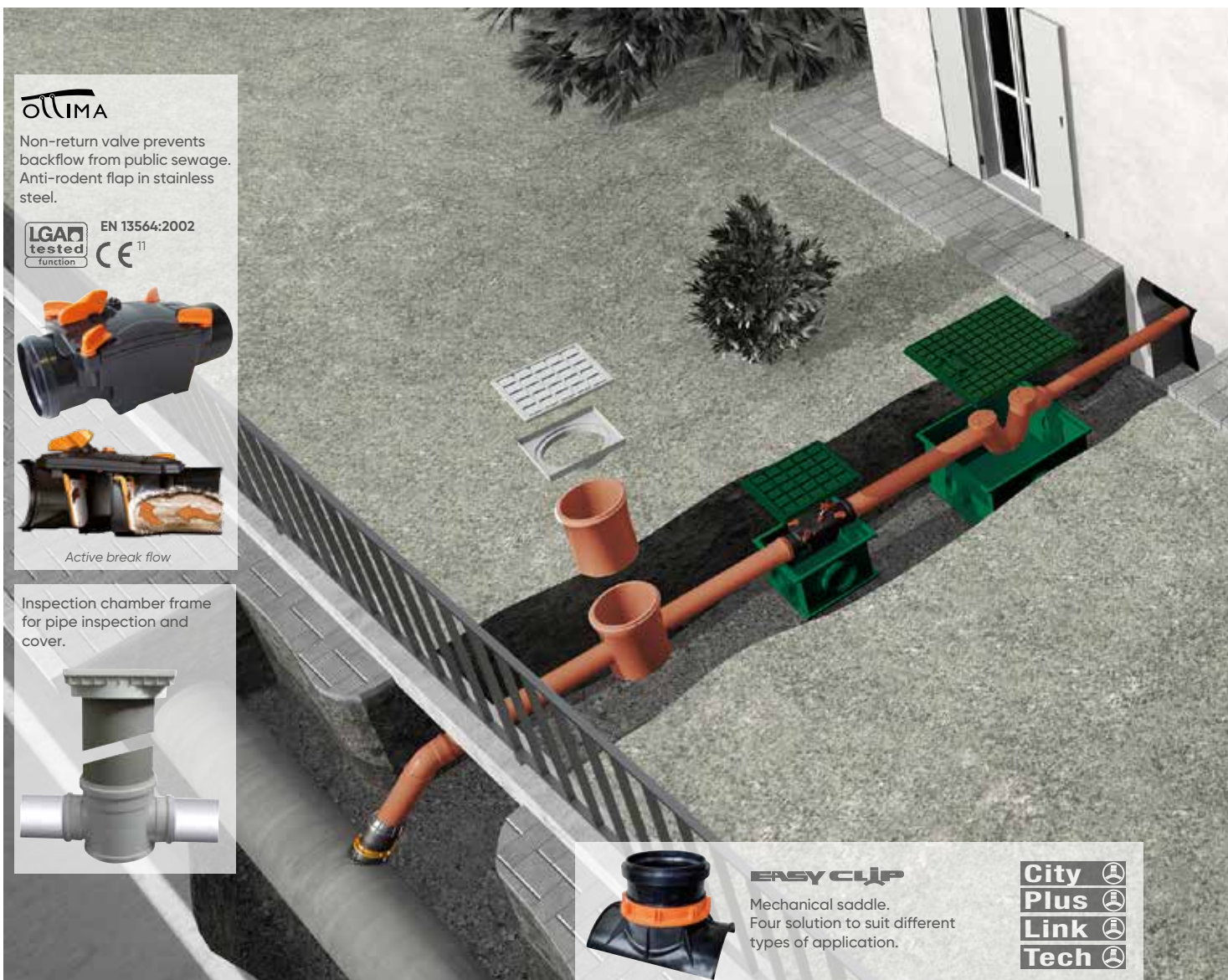

Certification: Underground sewage fittings



IIP: EN1401



BSI: EN1401



Ö Norm: EN1401



BENOR: EN1401



MPA: EN1401



AFNOR-CSTB:
ANF EN1401



KIWA-KOMO:
EN1401

Certification: Lip Ring



MPS NRW
Standard nr.
220000032 04-02-1b
DIN 4060



BSI
Standard nr. KM 51718
BS EN 681-1



KIWA KOMO
Standard nr. K4195/06
Type rubbe SBR ss-p-60-00



DNV Det Norske Veritas Certification Licence
Standard n.
112.929.01-01E SS-EN 681-1
Type test report:
SP report No. 98K12514
A-C, 98K 12558, 99K12583,
99K12604, F020847C, F101033

The list of the correspondence between these Certificates of Conformity and the complete range of products described is available upon request.

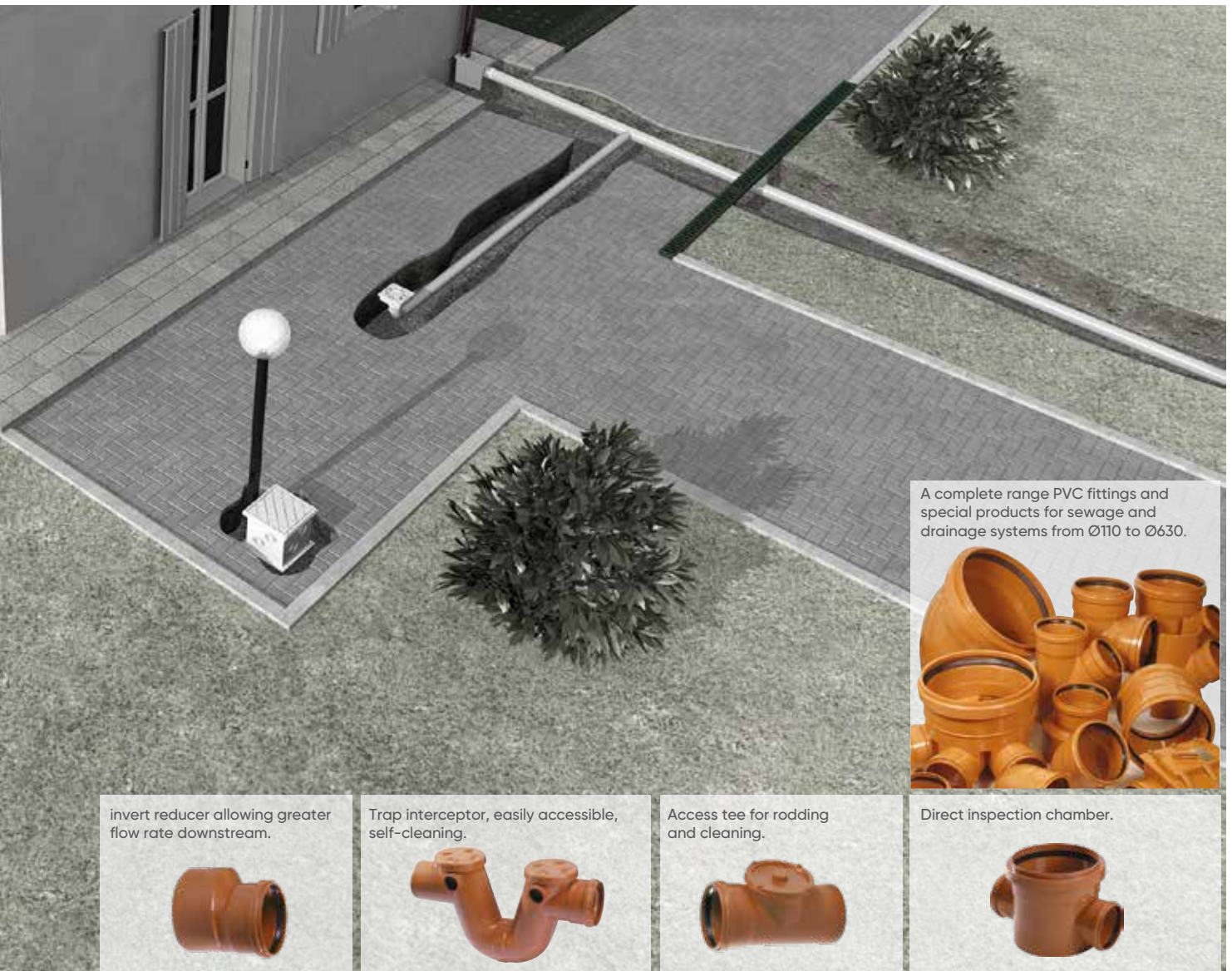

3.0 UGD & SEWAGE



A complete range PVC fittings and special products for sewage and drainage systems from Ø110 to Ø630.



invert reducer allowing greater flow rate downstream.



Trap interceptor, easily accessible, self-cleaning.

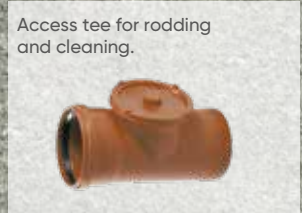

Access tee for rodding and cleaning.

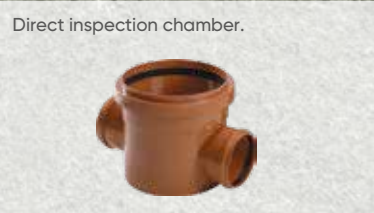

Direct inspection chamber.

Product Specifications

Underground Drainage and Sewage Fittings

REDI fittings are made of PVC-U for non-pressure underground drainage and sewage applications. Nominal ring Stiffness (SN) and Standard Dimension Ratio (SDR) are specified in this technical handbook according and compliant to the EN1401 and certified by several qualified standards institutes. Product range starts from Ø110 up to Ø630 push-fit jointing fittings (Socket/Spigot) with lip-sealing rings. The gaskets are compliant to the EN681-1 and certified by a standards institute.

The standard type marking for fittings :

- Manufacturer's name
- Quality Mark by third part certification (IIP, MPA etc.)
- EN1401 product norm
- Application area code ("U" or "UD")
- Nominal size
- Nominal angle
- SN or SDR

Inspection Chambers

Injected molded inspection chambers made of PVC-U or PP are designed to fit with piping systems connections according to EN1401 product norm. Elastomer lip seal ring jointing type is compliant to EN681-1 and DIN4060 standards.

The semi-circular smooth chamber base allows the stream continuity and prevents solid sediments even in low flow rate conditions. The chamber may be connected to a riser stack up to the surface ground level. The telescopic part admit the ground subsidences that might occur after installation or later height of the chamber adjustments.

The cover must be according to the specifications (material, loading class, locking devices).

Trap interceptors

Injected molded inspection sewage traps made of PVC-U are designed to fit with piping systems connections according to EN1329 and EN1401 product norm.

The gaskets are compliant to the EN681-1 and certified by a standards institute.

This trap interceptor must have the following technical features:

- No hand welding, only solvent welded or push-fit lip seal gasket jointing type
- Optimal hydraulic sealing (3/10 minimum diameter ratio) to avoid the passage of bad gas and smells
- 1 or 2 access screwed plugs
- Vent inlets for sewage gases relief, oxygen admittance to let the aerobic sewage digestion and trap water seal maintenance.

The environmental system of suppliers has been certified according to ISO 14001 international standard as purchases condition.

The quality system of suppliers has been certified according to ISO 9001 international standard





SN8 - SDR34

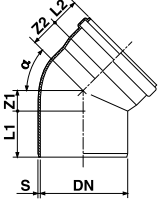

Bend S/S
Coude M/F - Codo M/H

DN	α	S	Z1	Z2	L1	L2	Reference RAL 7037 Grey			Note
125	45°	3,7	29	40	68	56	0702242*	25	200	SN8 SDR34
160	15°	4,7	14	28	82	72	0101742	15	120	SN8 SDR34
160	45°	4,7	37	51	80	66	0701542	10	80	SN8 SDR34

*upon request Fixed Ring



SN8 - SDR34

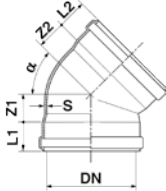

Bend D/S
Coude F/F - Codo H/H

DN (mm)	α	S (mm)	Z1 (mm)	Z2 (mm)	L1 (mm)	L2 (mm)	Reference RAL 7037 Grey			Note
125	45°	3,7	43	43	62	62	0232242	20	160	SN8 SDR34
160	15°	4,7	28	28	73	73	0211742	12	96	SN8 SDR34
160	45°	4,7	49	49	73	73	0231542	10	80	SN8 SDR34

Fixed Ring



SN8 - SDR34

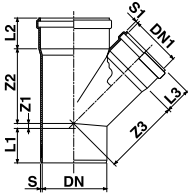

Branch 45° S/S
Culotte 45° M/F - Derivación 45° M/H

DN (mm)	DN1 (mm)	S (mm)	S1 (mm)	Z1 (mm)	Z2 (mm)	Z3 (mm)	L1 (mm)	L2 (mm)	L3 (mm)	Reference RAL 7037 Grey			Note
160	125	4,7	3,7	12	180	185	83	74	62	0313442*	6	48	SN8 SDR34

*upon request Fixed Ring



SN8 - SDR34

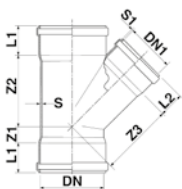

Branch 45° D/S
Culotte 45° F/F - Derivación 45° H/H

DN (mm)	DN1 (mm)	S (mm)	S1 (mm)	Z1 (mm)	Z2 (mm)	Z3 (mm)	L1 (mm)	L3 (mm)	Reference RAL 7037 Grey			Note
160	125	4,7	3,7	41	180	185	74	62	0311932	6	48	SN8 SDR34
200	125	5,9	3,7	54	228	232	86	74	0313932	4	32	SN8 SDR34
200	160	5,9	3,7	54	228	232	86	74	0312232	1	25	SN8 SDR34

Fixed Ring

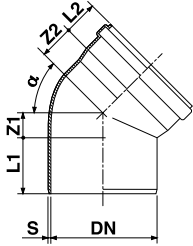
Bend 15° S/S**Coude 15° M/F - Codo 15° M/H**

DN (mm)	S (mm)	Z1 (mm)	Z2 (mm)	L1 (mm)	L2 (mm)	Reference RAL 7037 Grey (Fixed Ring Lip Ring)	Reference RAL 8023 Red Lip Ring			Note
110	3.2	9	22	62	50	0101142 •	010115E	40	320	
125	3.2	10	22	68	63	0101242 •	010125E	25	200	
160	4.0	14	28	82	72	0101642 •	010165E	13	104	
200	4.9	18	35	100	86	0102042 •	010205E	8	64	
250	6.2	19	40	134	103	0102552	0102591	1	36	
315	7.7	23	52	144	120	0103052	0103091	1	18	
400	9.8	83	80	175	175	1104052	1104091	1	10	
500	12.2	150	160	160	250	-	N105091* ♦	1	3	
630	-	-	-	-	-	-	N106391* ♦	1	1	

*upon request

Fixed Ring Lip Ring Fabricated SDR34

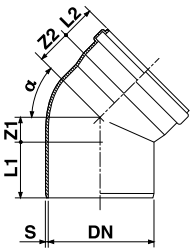
Bend 30° S/S**Coude 30° M/F - Codo 30° M/H**

DN (mm)	S (mm)	Z1 (mm)	Z2 (mm)	L1 (mm)	L2 (mm)	Reference RAL 7037 Grey (Fixed Ring Lip Ring)	Reference RAL 8023 Red Lip Ring			Note
110	3.2	17	29	61	50	0111142 •	011115E	40	320	
125	3.2	19	29	68	62	0111242 •	011125E	25	200	
160	4.0	25	40	82	72	0111642 •	011165E	13	104	
200	4.9	30	49	100	86	0112042 •	011205E	1	60	
250	6.2	37	59	134	103	0112552	0112591	1	33	
315	7.7	47	74	144	118	0113052	0113091	1	18	
400	9.8	65	98	165	140	1114052	1114091	1	8	
500	12.2	165	230	160	250	-	N115091* ♦	1	3	
630	-	-	-	-	-	-	N116391* ♦	1	1	

*upon request

Fixed Ring Lip Ring Fabricated SDR34

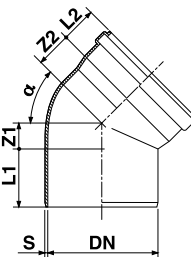
Bend 45° S/S**Coude 45° M/F - Codo 45° M/H**

DN (mm)	S (mm)	Z1 (mm)	Z2 (mm)	L1 (mm)	L2 (mm)	Reference RAL 7037 Grey (Fixed Ring Lip Ring)	Reference RAL 8023 Red Lip Ring			Note
110	3.2	27	36	58	50	0121142 •	012115E	35	280	
125	3.2	29	40	68	56	0701242 •	070125E	23	184	
160	4.0	37	51	80	66	0701642 •	070165E	10	80	
200	4.9	46	64	100	84	0702042 •	070205E	5	40	
250	6.2	58	79	125	96	0122552	0122591	1	27	
315	7.7	73	100	144	118	0123052	0123091	1	14	
400	9.8	91	126	165	140	1124052	1124091	1	7	
500	9.8	103	152	160	150	1125052	1125091	1	4	
630	-	-	-	-	-	-	N126391* ♦	1	1	

*upon request

Fixed Ring Lip Ring Fabricated SDR34

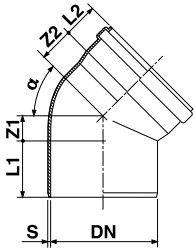

Bend 67°30' S/S
Coude 67°30' M/F - Codo 67°30' M/H

DN (mm)	S (mm)	Z1 (mm)	Z2 (mm)	L1 (mm)	L2 (mm)	Reference RAL 7037 Grey	Reference RAL 8023 Red			Note
110	3.2	41	53	62	56	0131142	013115E	30	240	
125	3.2	46	60	69	62	0131242	013125E	20	160	
160	4.0	60	74	82	74	0131642	013165E	10	80	
200	4.9	73	88	100	86	0132042	013205E	5	40	

Fixed Ring Lip Ring SN8 SDR34

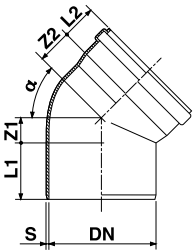

Bend 87°30' S/S
Coude 87°30' M/F - Codo 87°30' M/H

DN (mm)	S (mm)	Z1 (mm)	Z2 (mm)	L1 (mm)	L2 (mm)	Reference RAL 7037 Grey	Reference RAL 8023 Red			Note
110	3.2	59	69	58	50	0711142 •	071115E	25	200	
125	3.2	65	77	67	56	0711242 •	071125E	20	160	
160	4.0	84	96	80	66	0711642 •	071165E	10	80	
200	4.9	105	122	100	85	0712042 •	071205E	1	40	
250	6.2	132	154	136	103	0142552	0142591	1	20	
315	7.7	166	192	144	114	0143052	0143091	1	10	
400	9.8	211	244	160	140	1144052	1144091	1	6	
500	9.8	380	430	160	150	1145052 ♦	1145091* ♦	1	2	
630	-	-	-	-	-	-	N146391* ♦	1	1	

*upon request

Fixed Ring Lip Ring Fabricated SN8 SDR34

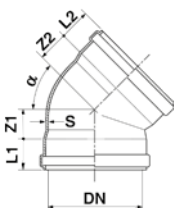

Bend 15° D/S
Coude 15° F/F - Codo 15° H/H

DN (mm)	S (mm)	Z1 (mm)	Z2 (mm)	L1 (mm)	L2 (mm)	Reference RAL 7037 Grey	Reference RAL 8023 Red			Note
110	3.2	20	20	56	56	0211342	0211341	35	280	
160	4.0	28	28	73	73	0211642	0211641	12	96	
200	4.9	33	33	82	86	1102142	1102141*	6	48	
250	6.2	64	42	101	101	1102242*	1102241*	1	33	
315	7.7	73	52	116	116	1103342*	1103341*	1	16	
400	9.8	52	70	133	142	1104452*	-	1	8	

*upon request

Fixed Ring SN8 SDR34

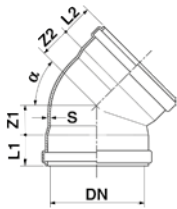

Bend 30° D/S Coude 30° F/F - Codo 30° H/H

DN (mm)	S (mm)	Z1 (mm)	Z2 (mm)	L1 (mm)	L2 (mm)	Reference RAL 7037 Grey	Reference RAL 8023 Red		
▶ 110	3.2	27	27	56	56	0221342	0221341	30	240
160	4.0	40	40	74	74	0221642	0221641	10	80
200	4.9	48	48	82	86	1112142	1112141*	5	40
250	6.2	81	61	101	101	1112242	-	1	27
315	7.7	88	75	116	116	1113342	-	1	12
400	9.8	80	100	133	142	1114452*	-	1	6

*upon request

Fixed Ring SN8 SDR34

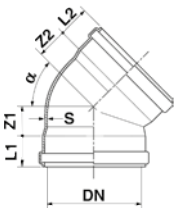

Bend 45° D/S Coude 45° F/F - Codo 45° H/H

DN (mm)	S (mm)	Z1 (mm)	Z2 (mm)	L1 (mm)	L2 (mm)	Reference RAL 7037 Grey	Reference RAL 8023 Red		
▶ 110	3.2	37	37	50	50	0231142	023115E	30	240
125	3.7	43	43	62	62	0231242	-	20	160
160	4.0	49	49	73	73	0231642	0231641	10	80
200	4.9	65	65	85	85	0232042	0232041	5	40
250	6.2	79	79	101	101	1232542	1232541	1	27
315	7.7	100	100	116	116	1233042	1233041	1	12
400	9.8	110	125	133	142	1234052	1234051*	1	6

*upon request

Fixed Ring SN8 SDR34

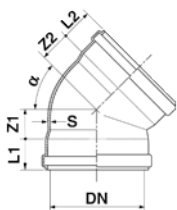

Bend 87°30' D/S Coude 87°30' F/F - Codo 87°30' H/H

DN (mm)	S (mm)	Z1 (mm)	Z2 (mm)	L1 (mm)	L2 (mm)	Reference RAL 7037 Grey	Reference RAL 8023 Red		
▶ 110	3.2	70	70	50	50	0241342	024135E	25	200
125	3.2	77	77	57	57	0241242	-	18	144
160	4.0	124	124	78	78	0241642	0241641	8	64
200	4.9	124	124	85	85	0242142	0242141	4	32
250	6.2	154	154	101	101	1242542	1242541	1	20
315	7.7	192	192	116	116	1243042	1243041	1	10
400	9.8	220	245	133	142	1244052	1244051	1	5

Fixed Ring SN8 SDR34



Long radius bend 87°30'
Coude grand rayon 87°30' - Codo largo radio 87°30'

DN (mm)	α	S (mm)	Z1 (mm)	Z2 (mm)	L1 (mm)	L2 (mm)	r (mm)	Reference RAL 7037 Grey	Reference RAL 8023 Red		
▶ 110	M/F	3.2	106	115	58	65	142	-	074115E	20	160
▶ 110	F/F	3.2	106	106	58	58	142	-	024115E	20	160

Lip Ring SDR34

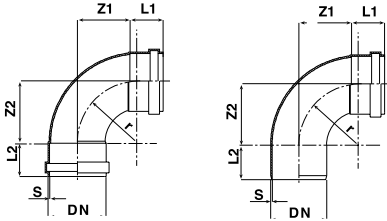

Long radius Branch 87°30'
Culotte grand rayon 87°30' - Derivación de largo radio 87° 30'

DN (mm)	Type	S (mm)	S1 (mm)	Z2 (mm)	L1 (mm)	L2 (mm)	L3 (mm)	Reference RAL 7037 Grey	Reference RAL 8023 Red		
▶ 110	F/F	3.2	2.9	146	62	57.5	57.5	0451342	045135E	15	120
▶ 110	M/F	3.2	2.9	146	62	57.5	57.5	-	089135E	15	120

Fixed Ring Lip Ring SDR34

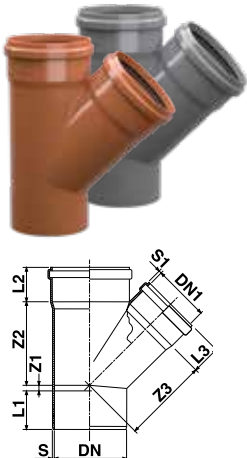
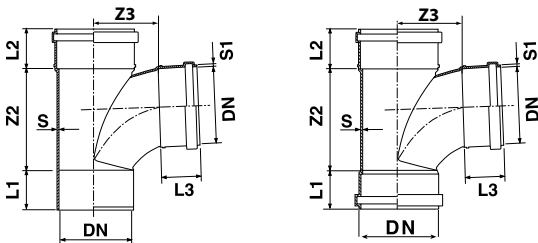

Branch 45° D/S
Culotte 45° M/F - Derivación 45° M/H

DN (mm)	DN1 (mm)	S (mm)	S1 (mm)	Z1 (mm)	Z2 (mm)	Z3 (mm)	L1 (mm)	L2 (mm)	L3 (mm)	Reference RAL 7037 Grey ()	Reference RAL 8023 Red ()		
▶ 110	110	3.2	-	25	140	140	60	50	50	0301142 •	030115E	15	120
125	125	3.2	-	25	160	160	70	64	64	0801242 •	080125E	10	80
160	160	4.1	-	37	201	201	81	67	67	0301642 •	030165E	4	32
200	200	4.9	-	45	256	256	100	81	81	0302042 •	0302051	1	20
250	250	6.2	-	57	311	311	134	101	101	0302552	0302591	1	12
315	315	7.7	-	73	392	392	144	114	114	1303052	1303091	1	5
400	400	9.8	-	170	510	535	165	175	170	-	N304091 ♦	1	2
500	500	12.3	-	240	665	675	200	250	255	-	N305091 * ♦	1	1
630	630	-	-	-	-	-	-	-	-	-	N306391 * ♦	1	1



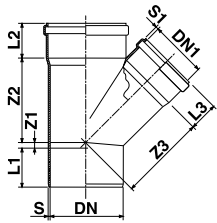

*upon request

Fixed Ring Lip Ring Fabricated SDR34



Reduced branch 45° D/S

Culotte embranchement 45° M/F - Derivación reducida 45° M/H

DN (mm)	DN1 (mm)	S (mm)	S1 (mm)	Z1 (mm)	Z2 (mm)	Z3 (mm)	L1 (mm)	L2 (mm)	L3 (mm)	Reference RAL 7037 Grey ( 	Reference RAL 8023 Red (		
125	110	3.2	3.2	19	147	152	69	62	56	0319242 •	031925E	10	80
160	110	4.0	3.2	2	168	176	82	74	56	0311642 •	031165E	7	56
160	125	4.0	3.2	12	180	185	83	74	62	0313642 •	031365E	6	48
200	110	4.9	3.2	17	191	200	100	86	56	0313542	031355E	4	32
200	125	4.9	3.2	7	201	212	100	86	62	0313742 •	031375E	4	32
200	160	4.9	4.0	18	228	232	100	86	74	0312042 •	031205E	3	24
250	110	6.2	3.2	47	251	271	175	103	56	0313352* ♦	0313391 ♦	1	20
250	125	6.2	3.2	27	217	236	196	98	56	-	D313491 ♦	1	16
250	160	6.2	4.0	3	250	261	131	103	74	0314052 ♦	0314091 ♦	1	20
250	200	6.2	4.9	24	275	280	134	103	86	0314152 ♦	0314191 ♦	1	14
315	160	7.7	4.0	33	289	306	144	114	75	0314252 ♦	0314291 ♦	1	12
315	200	7.7	4.9	5	317	337	144	114	85	0314352 ♦	0314391 ♦	1	10
315	250	7.7	6.2	28	335	344	156	114	99	D314452 ♦	D314491 ♦	1	5
400	110	9.8	3.2	130	450	435	165	170	65	-	1314451 ▲	1	4
400	160	9.8	4.0	69	319	385	165	170	95	-	1316651 ▲	1	4
400	200	9.8	4.9	50	355	435	165	180	105	-	1317751 ▲	1	4
400	250	9.8	6.2	35	440	445	165	180	130	-	D314691 ♦	1	3
400	315	9.8	6.9	73	480	530	160	170	135	-	D314791 ♦	1	3
500	160	10.5	4.0	65	450	680	200	250	90	-	1315351* ▲	-	-
500	200	10.5	4.9	87	400	575	200	250	110	-	1315451* ▲	-	-
500	250	12.3	6.2	10	510	530	200	250	110	-	D314991* ♦	1	3
500	315	12.3	6.9	45	475	503	200	250	135	-	D315091* ♦	1	2
500	400	12.3	9.8	115	615	640	200	250	180	-	D315191* ♦	1	1



*upon request

 Fixed Ring
  Lip Ring
  Fabricated
  Thermoformed

Branch 45° T/S

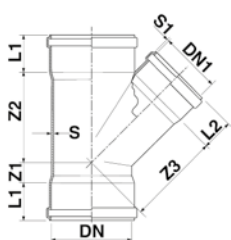
Culotte 45° F/F - Derivación 45° H/H



DN (mm)	DN1 (mm)	S (mm)	S1 (mm)	Z1 (mm)	Z2 (mm)	Z3 (mm)	L1 (mm)	L3 (mm)	Reference RAL 7037 Grey (	Reference RAL 8023 Red (		
▶ 110	110	3.2	3.2	37	137	137	60	60	0441142	0441141	12	96
125	125	3.2	3.2	44	160	160	64	64	0441242	0441241*	8	64
160	160	4.0	-	52	203	203	72	72	0441642	0441641	4	32
200	200	4.9	4.9	66	256	256	181	81	1442042	1442041	1	20
250	250	6.2	6.2	101	311	311	101	101	1442542	1442551	1	10
315	315	7.7	7.7	113	392	392	117	117	1443042	1443041	1	4

*upon request

 Fixed Ring
  SN8 SDR34

Reduced branch 45° T/S

Culotte embranchement 45° F/F - Derivación reducida 45° H/H

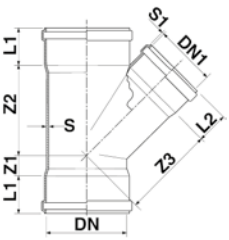

DN (mm)	DN1 (mm)	S (mm)	S1 (mm)	Z1 (mm)	Z2 (mm)	Z3 (mm)	L1 (mm)	L3 (mm)	Reference RAL 7037 Grey	Reference RAL 8023 Red		
160	110	4.0	3.2	19	169	176	73	56	0311742	0311741	6	48
160	125	4.0	3.2	41	180	185	74	62	0311832	-	6	48
200	110	4.9	3.2	5	179	195	86	62	1443142	1443141*	8	32
200	125	5.9	3.7	54	228	232	86	74	0313832	-	4	32
200	160	5.9	4.7	54	228	232	86	74	0312132	0312151	1	25
250	160	6.2	4.0	41	251	262	101	74	1444042	1444041	1	16
250	200	6.2	4.9	68	278	302	101	86	1444142	-	1	12
315	110	7.7	3.2	7	287	315	117	55	1443442*	1443451	1	10
315	125	7.7	3.2	7	287	310	117	68	1443542 ▲	-	1	10
315	160	7.7	4.0	7	287	305	117	74	1444242	1444241	1	10
315	200	7.7	4.9	35	317	338	117	86	1444342	-	1	8
315	250	-	-	-	-	-	-	-	-	1444551*	1	6
400	110	9.8	3.2	30	450	380	145	60	1444442*▲	-	1	5
400	160	9.8	3.2	30	450	410	145	90	1446642 ▲	-	1	5
400	200	9.8	3.2	30	450	430	145	100	1447742 ▲	1447741* ▲	1	4
500	110	10.5	3.2	185	360	420	180	250	* ▲	* ▲	-	-
500	125	10.5	3.2	55	510	475	165	170	* ▲	* ▲	-	-
500	160	10.5	4.0	65	450	680	200	250	* ▲	* ▲	-	-
500	200	10.5	4.9	87	400	575	200	250	* ▲	* ▲	-	-

*upon request

Fixed Ring Thermoformed

Branch 87°30' D/S

Culotte 87°30' M/F - Derivación 87°30' M/H

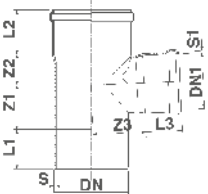

DN (mm)	DN1 (mm)	S (mm)	S1 (mm)	Z1 (mm)	Z2 (mm)	Z3 (mm)	L1 (mm)	L2 (mm)	L3 (mm)	Reference RAL 7037 Grey	Reference RAL 8023 Red		
110	110	3.2	3.2	55	69	69	60	50	50	0341142 •	034115E	20	160
125	125	3.2	3.2	66	70	78	62	62	62	0811242 •	081125E	12	96
160	160	4.0	-	76	98	98	88	74	74	0811642 •	081165E	5	40
200	200	4.9	-	105	119	119	100	86	86	0812042 •	081205E	1	30
250	250	6.2	-	120	152	152	135	101	101	0342552	0342591	1	18
315	315	7.7	7.7	166	185	174	146	114	114	1343052	1343091	1	8
400	400	9.8	9.8	250	270	230	215	175	175	1344052 ▲	1344051 ▲	1	2
500	500	12.3	12.3	265	355	345	295	245	245	-	N345091 ♦	1	2



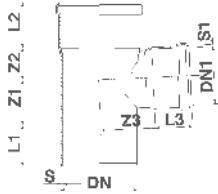

*upon request

Fixed Ring Lip Ring Fabricated Thermoformed SN8 SDR34



Reduced branch 87°30' D/S

Culotte embranchement 87°30' M/F - Derivación reducida 87°30' M/H



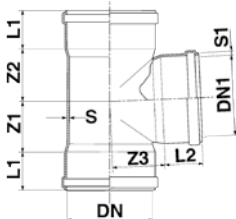

DN (mm)	DN1 (mm)	S (mm)	S1 (mm)	Z1 (mm)	Z2 (mm)	Z3 (mm)	L1 (mm)	L2 (mm)	L3 (mm)	Reference RAL 7037 Grey ( 	Reference RAL 8023 Red (		
125	110	3.2	3.0	84	58	92	78	77	67	-	0357251	12	96
160	110	4.0	3.2	59	69	87	81	74	57	-	035165E	10	80
160	125	4.0	3.2	60	81	94	88	71	62	0353642 •	0353651	1	70
200	110	4.9	3.2	50	110	120	135	86	59	0350142*	035015E	4	32
200	125	4.9	3.2	58	110	120	125	86	62	0350242	035025E	4	32
200	160	4.9	4.0	75	110	132	110	86	74	0352042 ♦	035205E ♦	4	32
250	110	6.2	3.2	90	100	132	144	99	51	-	0353551 ♦	1	20
250	160	6.2	4.0	90	100	134	117	126	85	0354042* ♦	0354051 ♦	1	18
250	200	6.2	4.9	132	143	136	123	120	116	-	0353851 ♦	1	18
315	110	7.7	3.2	50	150	176	180	116	56	-	1352251 ♦	1	10
315	160	7.7	4.0	75	150	180	155	116	73	-	1354451 ♦	1	12
315	200	7.7	4.9	95	150	185	135	116	87	-	1355551 ♦	1	12
315	250	7.7	6.2	166	178	174	128	140	110	D354652 ♦	D354691 ♦	1	6
400	110	9.8	3.2	153	183	240	180	145	60	-	1354151* ▲	1	5
400	160	9.8	4.0	120	205	135	215	160	87	-	1356651* ▲	1	4
400	200	9.8	4.9	145	240	145	215	175	104	-	1357751 ▲	1	4
400	250	9.8	6.2	186	227	270	180	145	105	-	1358851 ▲	1	4
400	315	9.8	6.9	186	227	260	180	145	125	1359952* ▲	1359951 ▲	1	4
500	110	10.5	3.2	163	205	290	210	170	60	-	1355051* ▲	-	-
500	250	10.5	6.2	-	-	-	210	170	105	-	D354991* ♦	1	3
500	315	10.5	6.9	-	-	-	210	170	125	-	D355091* ♦	1	2
500	400	10.5	9.8	-	-	-	210	170	145	-	D355191* ♦	1	1

*upon request

 Fixed Ring
  Lip Ring
  Fabricated
  Thermoformed

Branch 87°30' T/S

Culotte 87°30' F/F - Derivación 87°30' H/H

DN (mm)	DN1 (mm)	S (mm)	S1 (mm)	Z1 (mm)	Z2 (mm)	Z3 (mm)	L1 (mm)	L3 (mm)	Reference RAL 7037 Grey (	Reference RAL 8023 Red (		
125	125	3.2	3.2	83	78	78	62	62	0451242	-	10	80
160	160	4.0	4.0	95	99	99	72	72	0451642	0451641	5	40
200	200	4.9	4.9	120	120	120	86	86	1452042	1452041	1	28
250	250	6.2	6.2	165	152	152	101	101	1452542	1452541*	1	15
315	315	7.7	7.7	211	185	185	117	117	1453042	1453041	1	6
400	400	9.8	9.8	250	270	230	175	175	1454052 ▲	1454051 ▲	1	2

*upon request

 Fixed Ring



Reduced branch 87°30' T/S
Culotte embranchement 87°30' F/F - Derivación reducida 87°30' H/H

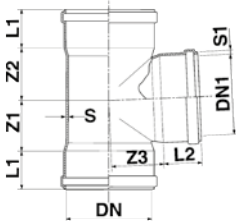

DN (mm)	DN1 (mm)	S (mm)	S1 (mm)	Z1 (mm)	Z2 (mm)	Z3 (mm)	L1 (mm)	L3 (mm)	Reference RAL 7037 Grey	Reference RAL 8023 Red		
160	110	4.0	3.2	70	75	95	72	56	-	0351741	8	64
160	125	4.0	3.2	85	81	94	72	62	0463642	-	6	48
200	110	4.9	3.2	108	110	120	86	60	-	0460141	1	33
200	125	4.9	3.2	108	110	120	86	62	0460242	-	4	32
200	160	4.9	4.0	108	110	132	86	74	0460642	0460641	1	30
250	125	6.2	3.2	100	100	132	103	130	1461242	-	1	18
250	160	6.2	4.0	100	100	134	107	126	1461642	1461651*	1	18
250	200	6.2	4.9	100	143	136	113	120	1462042*	1462051*	1	15
315	110	7.7	3.2	150	150	176	116	56	1464142*	1464141*	1	9
315	125	7.7	3.2	150	150	176	116	65	1464342	-	1	10
315	160	7.7	4.0	150	150	180	116	73	1464242	-	1	10
315	200	7.7	4.9	150	150	185	116	87	1464442	1464451	1	10
400	125	9.8	3.2	192	192	240	145	65	1463342*▲	-	-	-
400	200	9.8	4.9	192	192	250	145	95	-	1467741▲	1	4
400	250	9.8	6.2	227	227	270	145	105	1468842▲	-	1	4
400	315	9.8	7.7	227	227	260	145	125	1469942▲	-	1	3
500	110	10.5	3.2	163	205	290	210	170	*▲	*▲	-	-
500	125	10.5	3.2	163	205	290	210	170	*▲	*▲	-	-
500	160	10.5	4.0	163	205	300	210	170	*▲	*▲	-	-
500	200	10.5	4.9	163	205	300	210	170	*▲	*▲	-	-

*upon request

Fixed Ring Thermoformed



Double branch 45°
Culotte double 45° - Derivación doble 45°

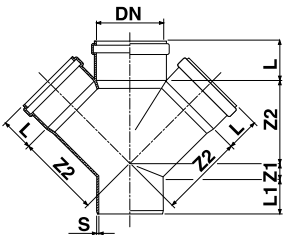

DN (mm)	S (mm)	Z1 (mm)	Z2 (mm)	L (mm)	L1 (mm)	Reference RAL 7037 Grey	Reference RAL 8023 Red			Note
▶ 110	3.2	30	141	57	60	0361142	0361141	8	64	
125	3.2	30	157	64	65	0361242	-	5	40	
160	4.0	51	204	85	88	0361642	-	1	30	

Fixed Ring SN8 SDR34



Double branch 87°30'
Culotte double 87°30' - Derivación doble 87°30'

DN (mm)	α	S (mm)	Z1 (mm)	Z2 (mm)	L (mm)	L1 (mm)	Reference RAL 7037 Grey		
110	87°30'	3.2	62	70	70	80	0381142	10	80

Fixed Ring SN8 SDR34

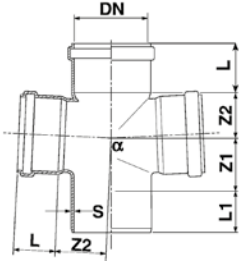

Access pipe
Té de visite - Té de registro

DN (mm)	DN1 (mm)	S (mm)	Z1 (mm)	Z2 (mm)	Z3 (mm)	L1 (mm)	L2 (mm)	L3 (mm)	Reference RAL 7037 Grey	Reference RAL 8023 Red		
110	110	3.0	59	69	69	60	55	36	1821142 •	182115E	20	160
125	125	3.2	66	70	78	62	62	22	1821242* •	182125E	15	120
160	160	4.0	83	99	99	85	72	24	1821642* •	182165E	1	65
200	200	4.9	105	119	119	100	86	28	1822042 •	182205E	1	30
250	250	6.2	120	152	152	135	101	70	1402552	1402591	1	16
315	315	7.7	166	185	185	146	114	90	-	1403091	1	8
400	315	9.8	227	227	260	180	145	30	1404352* ▲	1404351 ▲	1	4

*upon request

Fixed Ring Lip Ring Thermoformed

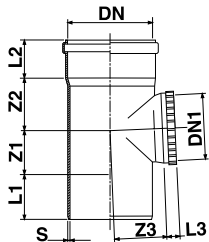

DN110 and DN125



DN160 and DN200



Access plug
Tampon de visite - Tapón de registro

DN (mm)	D1 (mm)	S (mm)	L1 (mm)	L2 (mm)	Reference RAL 7037 Grey	Reference RAL 8023 Red		
110	125	3.4	62	19	0651102	0651101	70	560
125	141	3.0	60	25	0651202	0651201	50	400
160	176	3.1	60	23	1651602	1651601	30	240
200	216	3.4	80	23	1652002	1652001	15	120

Lip Ring

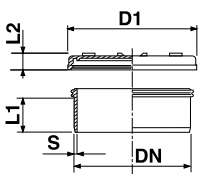

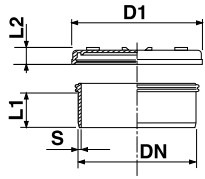

Access plug

Tampon à baïonnette male - Tapón de registro

DN (mm)	D1 (mm)	S (mm)	L1 (mm)	L2 (mm)	Reference RAL 7037 Grey	Reference RAL 8023 Red		
250	262	6.1	90	18	1652502	1652501	10	100
315	354	7.7	93	22	1653002	1653001	5	50

Lip Ring

Access end cap Female

Tampon à baïonnette femelle - Tapón de registro hembra

DN (mm)	D1 (mm)	S (mm)	L1 (mm)	L2 (mm)	Reference RAL 7037 Grey		
250	262	5.5	86	18	16525F2	10	100
315	330	6.9	89	22	16530F2	6	48

Lip Ring

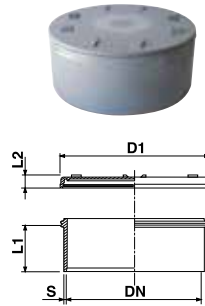

Socket plug

Bouchon de fermeture - Tapón macho

DN (mm)	D1 (mm)	S (mm)	L1 (mm)	Reference RAL 7037 Grey	Reference RAL 8023 Red		
110	126	3.2	38	0661102	066110E	150	1200
125	142	3.2	42	0661202	066120E	100	800
160	180	4.0	49	0661602	066160E	55	440
200	223	4.9	59	0662002	066200E	25	200
250	282	6.2	90	0662502	0662501	1	144
315	350	7.7	93	0663002	0663001	1	67
400	440	9.8	95	06640M2	06640M1	1	50
500	558	12.3	120	-	D665001 ♦	1	12

♦ Fabricated

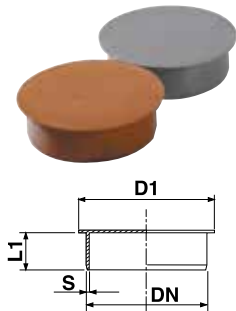

End cap

Bouchon femelle - Tapón hembra

DN (mm)	S (mm)	L1 (mm)	Reference RAL 7037 Grey	Reference RAL 8023 Red		
110	2.0	32	06613F2	06613F1	30	1560
125	2.5	32	06615F2	06615F1	20	1040
160	2.7	35	06617F2	06617F1	30	720
200	2.9	35	06621F2	06621F1	60	480
250	3.5	40	06628F2	06628F1	30	240
315	4.0	52	06634F2	06634F1	15	120
400	6.0	95	06640F2	06640F1	1	50

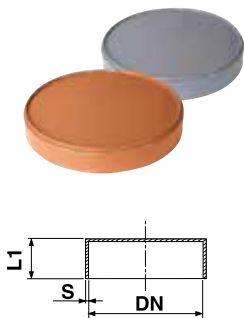



Access chamber

Inspection linéaire - Inspección en línea

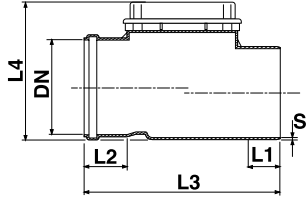

DN (mm)	S (mm)	L1 (mm)	L2 (mm)	L3 (mm)	L4 (mm)	Reference RAL 8023 Red		
110	4.0	61	61	307	192	1475551*	9	72
125	4.0	68	65	318	192	1476051*	8	64
160	4.0	74	74	334	220	1471691*	6	48
200	4.5	100	86	451	280	1472091*	2	16

*upon request Lip Ring

Invert reducer

Réduction excentrée - Ampliación excéntrica

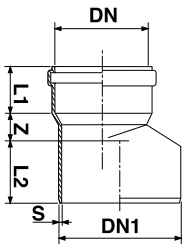

DN (mm)	DN1 (mm)	S (mm)	Z (mm)	L1 (mm)	L2 (mm)	Reference RAL 7037 Grey 	Reference RAL 8023 Red 		
110	125	3.2	22	56	63	0513242 •	051325E	35	280
110	160	4.0	43	56	82	0511642 •	051165E	30	240
125	160	4.0	36	62	82	0513642 •	051365E	30	240
125	200	4.9	53	62	100	0512042 •	051205E	15	120
160	200	4.9	39	74	100	0514042 •	051405E	15	120
160	250	6.2	66	73	125	0514642	0514651	1	85
200	250	6.2	39	96	134	0512542 •	051255E	5	60
200	315	7.7	85	86	145	0513342 •	051335E	4	32
250	315	7.7	64	103	144	0513052	0513091	1	32
315	400	9.8	88	118	156	0519252	0519291	1	18
400	500	-	-	-	-	-	D519491 **	1	4

**Centrée / Escentrée / Concéntrico

NB: other larger diameters available upon request / diamètres supérieurs disponibles sur demande.

Fixed Ring Lip Ring Fabricated

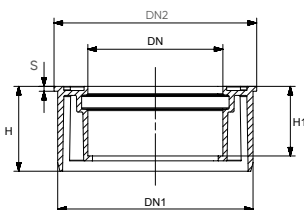

Compact inverter reducer

Tampon de réduction avec joint - Reducción concéntrica

DN (mm)	DN1 (mm)	DN2 (mm)	H (mm)	H1 (mm)	S (mm)	Reference Black 		
110	160	166	69.5	57	4	0686348	16	384

Recommended for installation on Easyclip City, Link and Tech



Flat invert reducer Réduction excentrée - Ampliación excéntrica

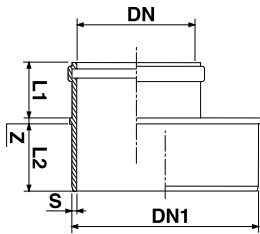

DN (mm)	DN1 (mm)	S (mm)	Z (mm)	L1 (mm)	L2 (mm)	Reference RAL 7037 Grey	Reference RAL 8023 Red			Note
110	200	4,6	40	60	59	1533542	1533551	15	120	
110	250	6.1	7	56	90	0534142	0534151	10	80	
110	315	7.7	40	60	93	-	1534051*	5	40	
110	400	6.0	40	60	95	1535042*	-	7	28	
125	250	6.1	7	62	90	0534242	0534251	10	80	
125	315	7.7	40	65	93	1534342	1534351*	5	40	
125	400	6.0	40	65	95	1535542	1535551*	-	-	
160	315	7.7	7	74	93	0534842	0534851	5	40	
160	400	6.0	50	85	95	1536042*	1536051*	1	26	
200	400	6.0	50	95	95	1536542*	1536551	1	26	
250	400	6.0	50	105	95	1537052	1537091	1	24	

*upon request

Fixed Ring Lip Ring Fabricated

Clay/PVC adaptor Manchon d'adaptation Grès/PVC - Enlace mixto Gres/PVC

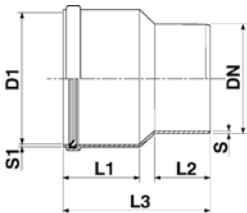

DN (mm)	DN1 (mm)	S (mm)	S1 (mm)	L1 (mm)	L2 (mm)	L3 (mm)	Reference RAL 7037 Grey	Reference RAL 8023 Red		
110	136	3.0	3.0	89	60	170	0621192	0621191	30	240
125	160	3.4	3.0	98	67	190	0621292	0621291	18	144
160	190	4.0	3.6	112	81	215	0621692	0621691	10	80
200	242	5.5	4.5	125	100	255	-	0622091	1	60

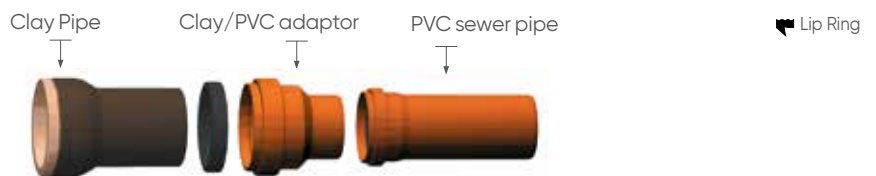

PVC/Clay adaptor Manchon d'adaptation PVC/Grès - Enlace mixto PVC/Gres

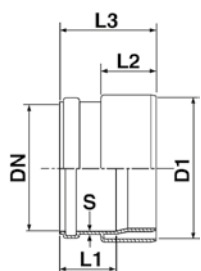

DN (mm)	DN1 (mm)	S (mm)	L1 (mm)	L2 (mm)	L3 (mm)	Reference RAL 8023 Red		
110	136	3.0	56	70	114	0621091	50	400
160	190	3.6	72	70	123	0621791	20	160

Lip Ring





Sanded protection sleeve

Accès de regard sablé court - Manguito pasamuros

DN (mm)	S (mm)	L1 (mm)	Reference Sandblasted ↙	Reference RAL 7037 Grey ↙			Note
160	3.6	74	-	0641642	12	168	

Lip Ring

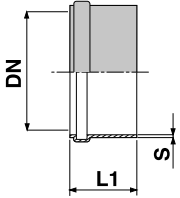

Double socket with central stop

Manchon avec butée - Manguito de unión con tope

DN (mm)	S (mm)	L1 (mm)	L2 (mm)	Reference RAL 7037 Grey (•) ↙	Reference RAL 8023 Red ↙		
110	2.9	60	122	0631142 •	063115E	45	360
125	2.9	68	141	0631242 •	063125E	30	240
160	3.6	75	151	0631642 •	063165E	18	144
200	4.4	106	217	0632042 •	063205E	8	64
250	5.5	123	254	0632552	0632591	1	36
315	6.9	144	297	0633052	0633091	1	20
400	8.8	160	325	0634052	0634091	1	12
500	9.8	170	440	1635052 ▲	1635051 ▲	1	4

Fixed Ring Lip Ring Thermoformed

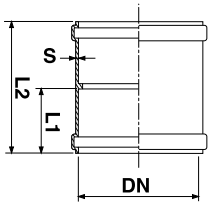

Single socket with central stop

Manchon mixte avec butée - Unión mixta con tope

DN (mm)	S (mm)	L1 (mm)	L2 (mm)	Reference RAL 7037 Grey ↙	Reference RAL 8023 Red ↙		
110	2.9	60	122	0631182*	0631181	20	360
125	2.9	68	141	-	0631281*	16	256
160	3.6	75	154	-	0631681*	10	120
200	4.4	106	217	-	0632081*	5	60
250	5.5	123	254	-	0632581*	4	32
315	6.9	144	297	-	0633081*	4	20

*upon request Lip Ring

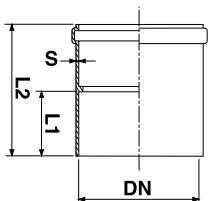



Repair/Slip coupler Manchon coulissant - Manguito deslizante

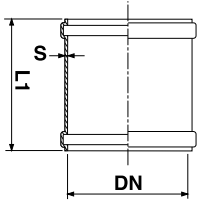

DN (mm)	S (mm)	L1 (mm)	Reference RAL 7037 Grey ☛ ☜	Reference RAL 8023 Red ☜		
110	2.9	122	0611142 •	061115E	45	360
125	2.9	141	0611242 •	061125E	30	240
160	3.6	151	0611642 •	061165E	18	144
200	4.4	217	0612042 •	061205E	8	64
250	5.5	254	0612552	0612591	1	36
315	6.9	297	0613052	0613091	1	20
400	8.8	325	0614052	0614091	1	12
500	9.8	440	1615052 ▲	1615051 ▲	1	4
630	-	-	-	D616391 ◆	1	3

☛ Fixed Ring ☜ Lip Ring ◆ Fabricated ▲ Thermoformed

Universal Gully trap Siphon pour siège à la turque en PP Sifón placa turca en PP con junta labiada



DN (mm)	H (mm)	L (mm)	Z1 (mm)	Z2 (mm)	Material	Reference RAL 8023 Red ☜		
110	142	310	225	50**	PP	Z7713PP	10	80

** Siphon 50 mm (when fitted with 45° bend)

☛ Fixed Ring ☜ Lip Ring

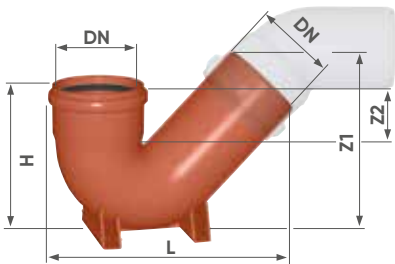

REDI trap interceptor Siphon à joint male/femelle - Sifón en línea con registros



DN (mm)	DN1	S	L1	L2	L3	L4	L5	L6	Reference RAL 7037 Grey ☜	Reference RAL 8023 Red ☜		
110	40	3.0	61	202	88	495	35	153	1750052	1750091	5	35
125	40	3.0	62	235	92	490	38	175	1751352	1751391	1	34

☛ Fixed Ring ☜ Lip Ring

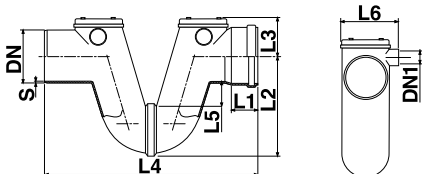



REDI trap interceptor
Siphon à joint male/femelle - Sifón en línea con registros

DN (mm)	DN1 (mm)	S (mm)	L1 (mm)	L2 (mm)	L3 (mm)	L4 (mm)	L5 (mm)	L6 (mm)	Reference RAL 7037 Grey	Reference RAL 8023 Red		
160	63	3.0	72	295	158	655	50	210	1751652	1751691	1	18
200	63	4.0	84	345	198	795	50	270	1752052	1752091	1	9

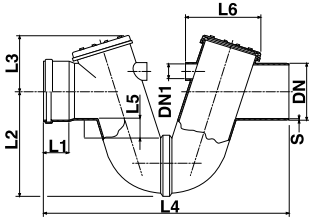

Fixed Ring Lip Ring



Bend 45° with access plug
Coude de visite 45° - Codo 45° con registro

DN (mm)	DN1 (mm)	S (mm)	Z1 (mm)	Z2 (mm)	L1 (mm)	L2 (mm)	Reference (SX) RAL 7037 Grey	Reference (DX) RAL 8023 Red		
110	63	3,2	27	36	58	50	N1C88E1	N1C87E1*	5	-
125	80	3,2	29	40	68	56	11912S1*	11912D1*	5	-
160	100	4,0	37	51	80	66	11916S1	11916D1	5	-

*upon request Lip Ring Fabricated

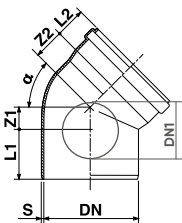

Branch 45° with access plus
Culotte 45° avec accès latéral - Derivación 45° con registro lateral

DN (mm)	Reference (SX) RAL 7037 Grey	Reference (DX) RAL 8023 Red			Note
110	N1C86E1	N1C85E1*	5	100	
125	1854451	1853351	5	50	
160	1856651	1855551	5	25	
200	1858851	1857751*	1	18	

*upon request Lip Ring Fabricated



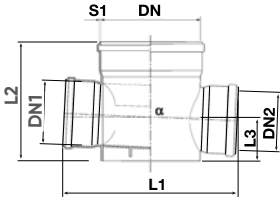

Inspection chamber

Boîte de branchement direct - Colector de registro

DN (mm)	DN1 (mm)	DN2 (mm)	S1 (mm)	L1 (mm)	L2 (mm)	L3 (mm)	α	Reference RAL 7037 Grey		
250	125	125	4.0	406	300	110	2°	1943042 ≈	1	37
315	125	125	5.0	459	320	115	2°	1953042 ≈	1	26
250	160	160	4.0	436	300	110	2°	1943242 ≈	1	34
315	160	160	5.0	491	320	115	2°	1953242 ≈	1	23
400	160	160	7	570	412	148	2°	1962942* ≈	1	10

*upon request
 ≈ RAL 8023 Red available on request
 Lip Ring

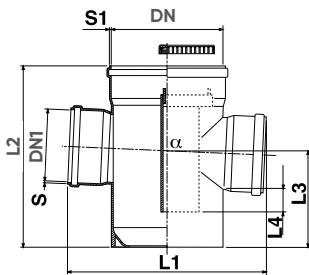

Trapped inspection chamber

Boîte de branchement siphonoïde Colector sifónico en línea

DN (mm)	DN1 (mm)	S1 (mm)	L1 (mm)	L2 (mm)	L3 (mm)	L4 (mm)	α	Reference RAL 7037 Grey		
250	125	4.0	406	405	215	67.5	2°	1944642	1	19
315	125	5.0	459	422	217	67.5	2°	1954642	1	12
250	160	4.0	436	405	215	50	2°	1944842	1	17
315	160	5.0	491	422	217	50	2°	1954842	1	10

Lip Ring

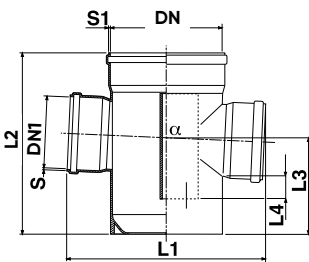

Inspection chamber with c. baffle

Boîte de branchement disconnectrice Colector de inspección desconector

DN (mm)	DN1 (mm)	S1 (mm)	L1 (mm)	L2 (mm)	L3 (mm)	L4 (mm)	α	Reference RAL 7037 Grey		
250	125	4.0	406	405	215	67.5	2°	1943842	1	19
315	125	5.0	459	422	217	67.5	2°	1953842	1	12
250	160	4.0	436	405	215	50	2°	1944042	1	17
315	160	5.0	491	422	217	50	2°	1954042	1	10

Lip Ring



Heavy inspection chamber
Tabouret lesté passage direct
Colector de inspección resistente a carga

DN (mm)	DN1 (mm)	S (mm)	S1 (mm)	L1 (mm)	L2 (mm)	L3 (mm)	α	Kg	Material	Reference RAL 7037 Grey		
315	125	4,9	3,0	459	283,5	103	2°	7,50	PP	1951242	1	18
315	160	4,9	3,6	480	316,5	119	2°	7,70	PP	1951642	1	21
315	200	4,9	4,5	505	356,5	139	2°	8,20	PP	1952042	1	18

Lip Ring

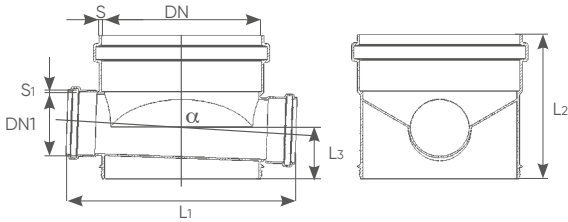

Access junction basis
Regard à 3 entrées - Colector de inspección 3 entradas

DN (mm)	DN1 (mm)	S (mm)	L1 (mm)	L2 (mm)	L3 (mm)	L4 (mm)	α	Reference RAL 8023 Red			Note
400	160	5	74	85	275	605	45°	196435X	1	6	3E.M/F - RML

Lip Ring

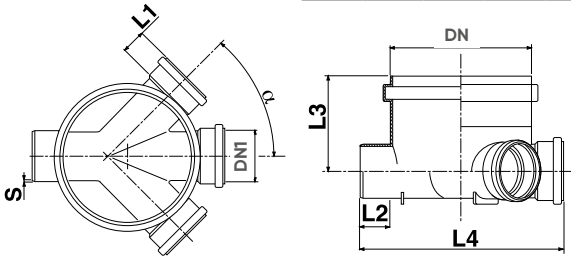

Access junction basis
Regard à 2 entrées - Colector de inspección 2 entradas

DN (mm)	DN1 (mm)	S (mm)	L1 (mm)	L2 (mm)	L3 (mm)	L4 (mm)	α	Reference RAL 8023 Red			Note
400	160	5	74	85	275	605	0°	196495X	1	8	MF PD - G

Lip Ring

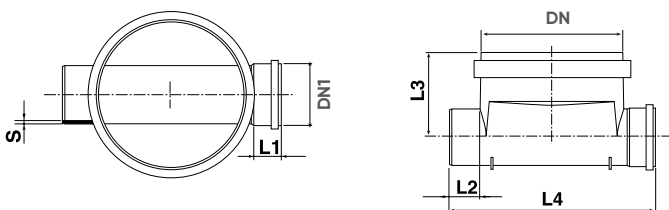



Access junction basis 400x200 Schachtboden
Regard à 3 entrées - Colector de inspección 3 entradas

DN (mm)	DN1 (mm)	α	H (mm)	L1 (mm)	Material	Reference Black			Note
400	200	45°	475	630	PP	POZ4208	1	8	

Lip Ring

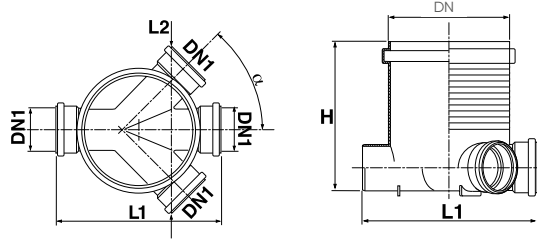

Access junction basis
Regard à 3 entrées - Colector de inspección 3 entradas

DN (mm)	DN1 (mm)	S (mm)	L1 (mm)	L2 (mm)	L3 (mm)	L4 (mm)	L5 (mm)	α	Reference RAL 8023 Red			Note
400	160	5	74	85	130	605	230	45°	096435X	1	12	3E.M/F - RML
400	160	5	74	85	130	605	230	0°	096495X*	1	16	MF PD - G

*upon request Lip Ring

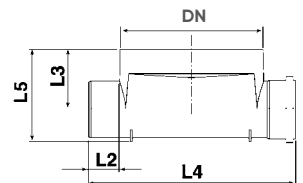
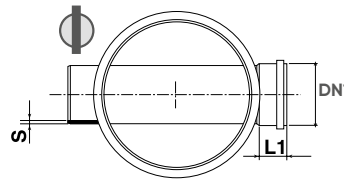
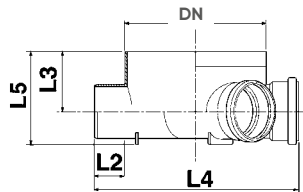
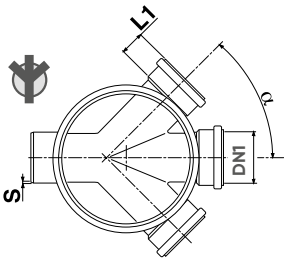

Round/Square frame for pipe inspection
Cadre Carré/Rond - Cerco cuadrado con para colector de inspección

DN (mm)	Ø1 (mm)	Ø2 (mm)	H1 (mm)	H2 (mm)	Reference RAL 7037 Grey			Note
450x450	400	315	50	65	ETTQ304	1	40	

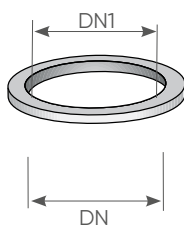
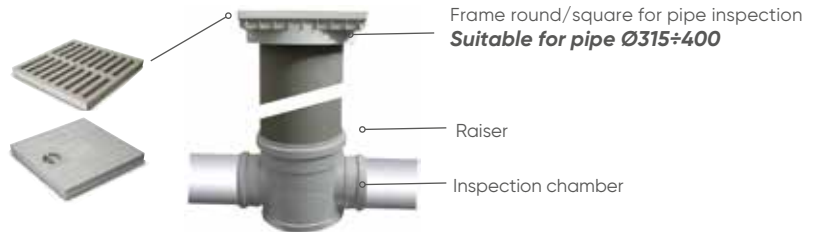
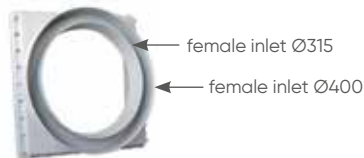
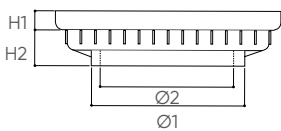
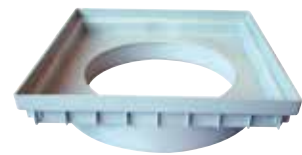

Telescopic gasket
Joint télescopique - Junta telescópica

DN (mm)	DN1 (mm)	Reference RAL 7037 Grey			Note
315	400	6834300*	1	66	

*upon request

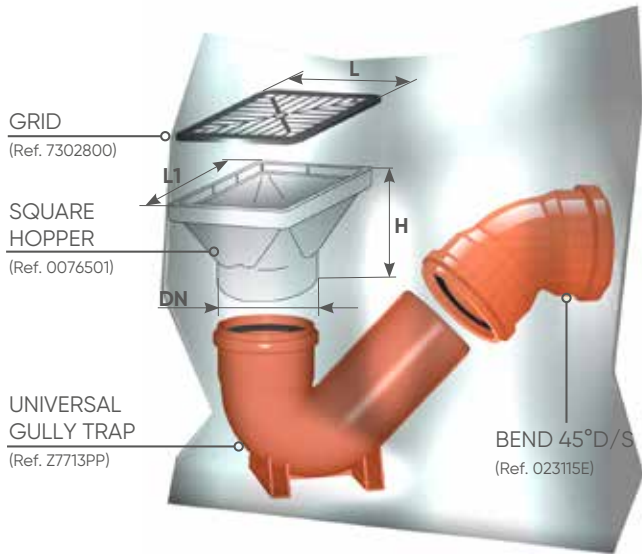

Gully Kit

Reference RAL 8023 Red			Note
1KIT15E	6	48	

Reference RAL 8023 Red	Note	DN (mm)	H (mm)	L (mm)	L1 (mm)
7302800	Grid			150	
0076501	Square Hopper	110	99		160
023115E	Bend 45° D/S	110			
Z7713PP	PP Universal Gully Trap	110			



Universal Gully trap

Siphon pour siège à la turque en PP

Sifón placa turca en PP con junta labiada

DN (mm)	H (mm)	L (mm)	Z1 (mm)	Z2 (mm)	Material	Reference RAL 8023 Red		
110	142	310	225	50**	PP	Z7713PP	10	80

**Siphon 50mm (when fitted with 45° bend)

Lip Ring

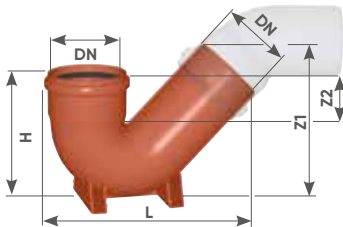

Adjustable bend

Coude orientable - Codo orientable

DN (mm)	α	S (mm)	Z1 (mm)	Z2 (mm)	L1 (mm)	L2 (mm)	Reference RAL 8023 Red		
110	5°÷ 30°	3.2	26	36	62	59	H999941	6	144

Lip Ring

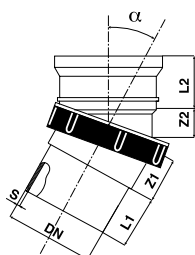

Swivel 160
Rotule 160 - Rótula 160

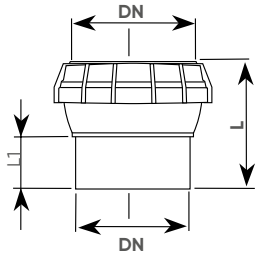

DN (mm)	α	L (mm)	L1 (mm)	Reference Black		
160	+/-10°	180	85	1991658	1	96

Lip Ring

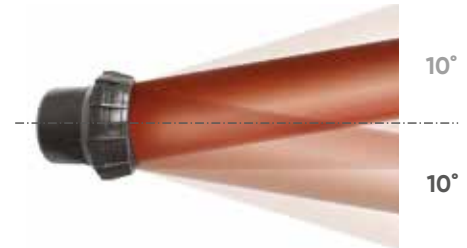

Patent: EP 040298754

Swivel DN 160 mm.

Pre-lubricated and ready-to-install. Rotation up to 10° to facilitate house connections and balance ground settlement.



Pipe length 3 meters

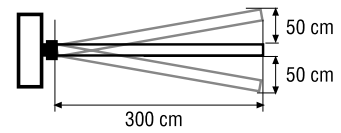

Pipe length 4 meters

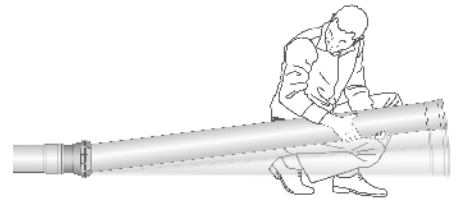
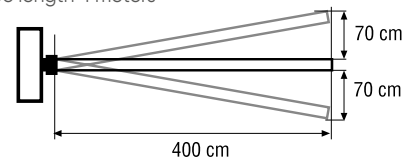

OTTIMA and CLASSICA

Non Return & Flap Valves



3.1 NON RETURN & FLAP VALVES

EN 13564 Type 0, 1, 2 Models
Solvent Welded and Push-Fit
Connections



Reasons to install backflow prevention device

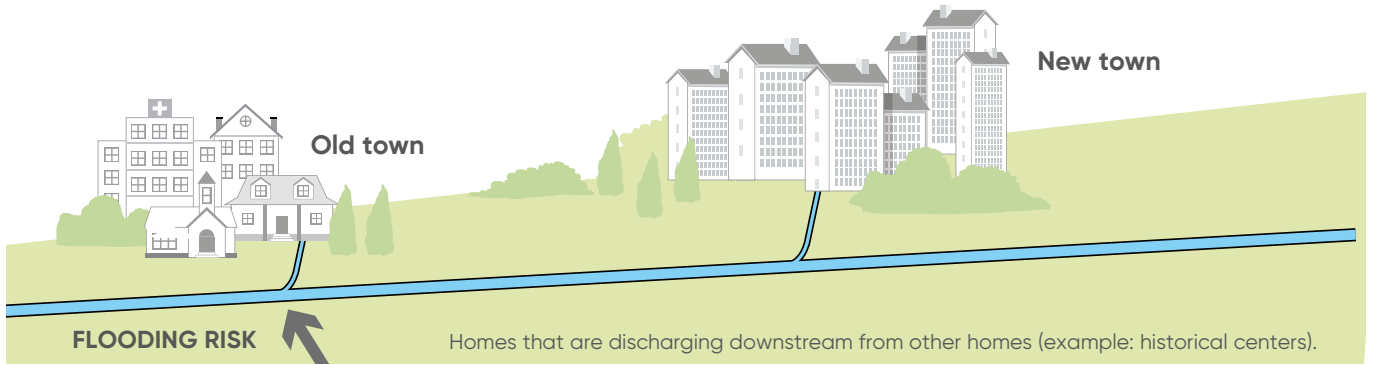

The causes of backflow

Back flow from the public sewer system is mainly caused by:

- overall under-sizing of the public sewers
- high peak flows in stormwater sewers or combined sewers due to short but intense rainfall (climatic trend throughout the world)
- increase of surface water runoff due to new construction (growing territorial urbanization), causing greater volume of flow
- overflow due to peaks of simultaneous flow in built up areas
- malfunctions or blockages downstream from the grid.

The typical situations that may lead to this problem are various and are related to the urban area involved. Several examples:

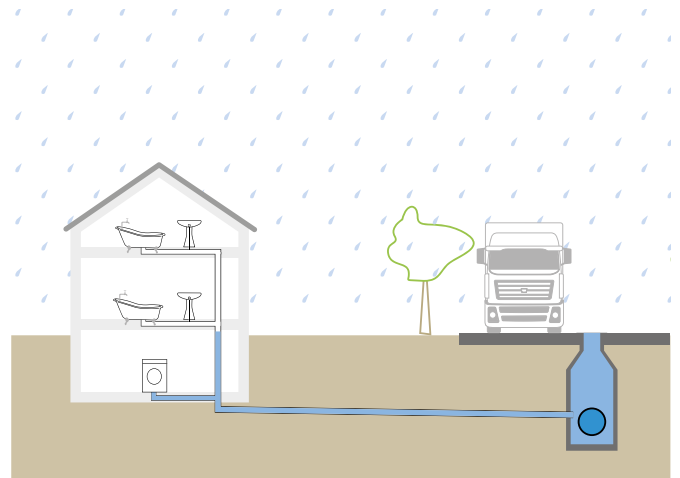

Combined sewers that also collect road drainage

Basements

These are only some of the many cases in which sewer overflow risk is high and installation of a backflow prevention device is recommended.

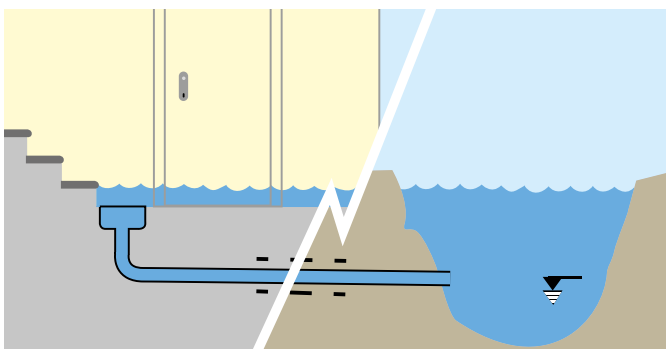
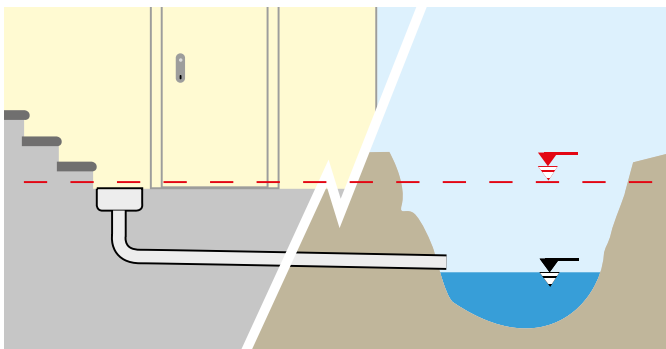

Riverside areas



Hydraulic principles: reflux level

On the grounds of the “Communicating Vessels Principle”, water tends to settle at even levels in all branches of the sewer network.

Hence, it is possible to define the concept of “backflow level” as the maximum level in a sewer system before water reflux occurs from the system itself. All of the utilities below the backflow level of a sewer system (usually basements, cellars and garages, as well as living quarters below street level, face flood risk as grid flows exceed maximum tolerance levels with greater frequency. Let’s schematically examine the consequences of main sewer backflow.

1. Standard use: The main sewer is receptive; the pipes within the home utilities are under safe hydraulic measures.
2. Overflow use – even temporarily: given that the backflow level in this scheme corresponds with street level (over maximum level, which corresponds to manhole height in this case, fluid may seep from the system), any grid overflow shall lead to the distribution of water in all branches communicating with the main sewer, until reaching a back flow level marked with the red dotted line.

Home risk floods following main sewer overflow. The non-return valve is active.

In this case the house is protected against flood risk. This diagram represents a typical scenario that may occur in any home with areas prone to flood risk in regards to the backflow level line. Unwanted events may take place if the sewer manifold overflows.

Backflow protection may be necessary in separate sewers, where foul and stormwater flow into separate systems, and in cases of combined sewers because backflow typically indirectly involves foul water circuits due to storm water overflow. This problem is normal in areas that do not have separate systems, which concerns the majority of cases. Discharge water backflow risk is simple to solve by installing a fundamental component in new drainage systems and in modernization of existing grids – the non-return Valve. Its working principle is extremely simple but also very effective.

NORMAL FUNCTION

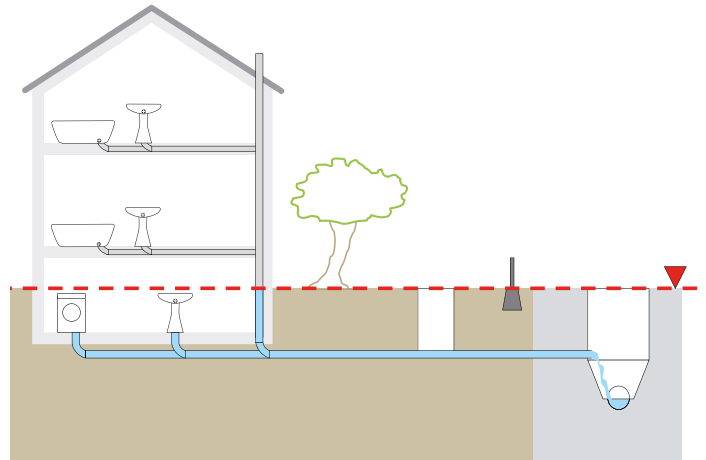

NON PROTECTED

Back flow event: without non-return valve

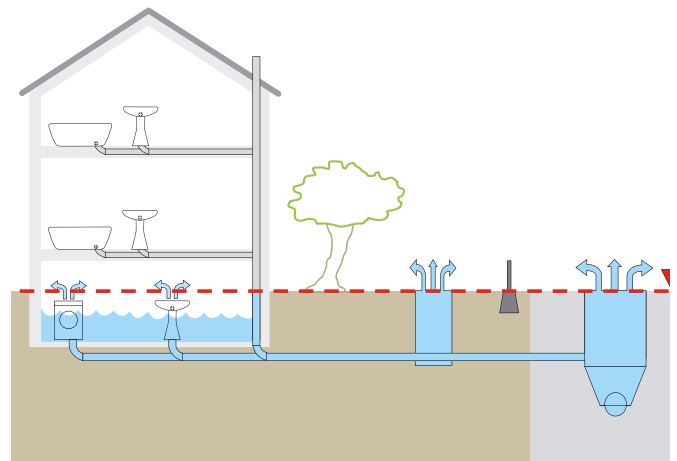

PROTECTED

Back flow event: with non-return valve

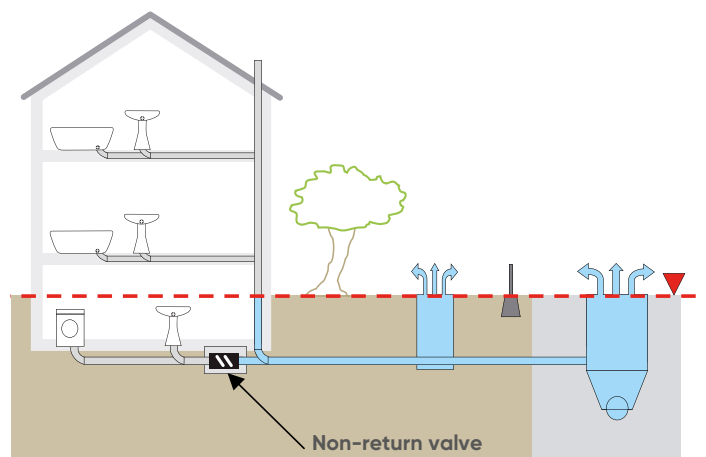

Legislative aspects of water grid construction and management

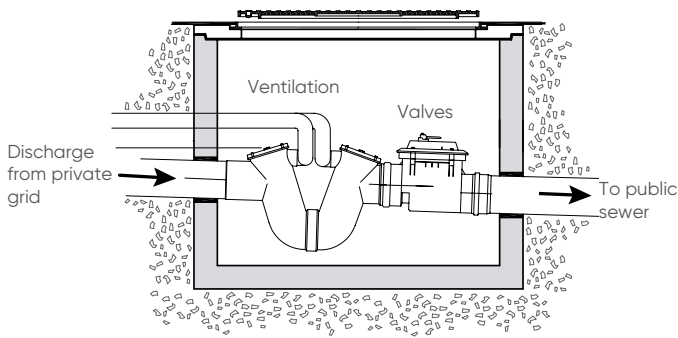

integrated water utility management

In Italy, as throughout Europe, water grid management has been delegated to Integrated Water Services since the start of the 90s. Water grid management passed from the hands of Municipality Management to subjects referred to as Water Companies, which ensure a benchmark level of quality in return for an utility fee, as by the stipulated utility contract. The various Water Companies in Italy are responsible for service provision and system maintenance and good operating conditions.

Hence, these utilities have introduced a series of technical guidelines concerning various aspects on design and construction of water grids that serve as condition for public and private subjects that intend to benefit from such systems under Contract. The technical guidelines include the manner of connection to the sewers by private and public users.

Guidelines

These guidelines must be respected both by enterprises and private citizens alike. The contractor that executes works for the Utility Company must strictly follow the execution guidelines received. Likewise, the citizen that requires, for example, connection of a new utility must follow these prescriptions according to established procedures.

Duties

In case of not comply with foregoing prescriptions, the Utility Company is free to decline Contract stipulation for use of public sewer systems; and may press for compensation of any damages caused by the infringing party. Currently, many local Water Companies already expect the installation of a backflow prevention valves when connecting a utility to the public sewers to prevent back flow risk. The image above is an example of prescription. It represents the connection before the public sewage.

OTTIMA non-return valve with stainless steel flap AISI 304

The new OTTIMA non-return valve was designed to meet the highest technological standards on the market. OTTIMA is manufactured with modern technology that ensures high-product standards and reliability.

Innovative

The innovation that is expressed through its design:

- increased safety
- search for functionality
- improvement of product features
- new technical requirements

OTTIMA contains a series of new features that make it a new reference product.



OTTIMA M/F Ø 100 - 110 mm



OTTIMA M/F Ø125 - 160 mm

Opens in extremely reduced spaces OTTIMA's cover can be removed without any tools, screwdrivers or wrenches by directly acting on the sealing levers.



The figure shows valve opening in the vicinity of walls of sewer trap edges. They are manufactured in high-stability nylon polymer for excellent resistance in time, though all parts may be replaced.



Standard inox flap: OTTIMA is fitted with a series of anti-rodent devices in stainless steel; therefore making it impossible for rodents to travel upwards through water pipelines... Additional protective features!

No metal parts: no metal parts ensure resistance to the test of time given the lack of corrosion. All components such as screws, bolts and pins have been eliminated to ensure greater time resistance. The only metal part is the stainless steel anti-rodent device.

No equipment needed: OTTIMA poses a definitive solution to tools required for maintenance. It is designed for full inspection, disassembly and re-assembly without using special tools. Thanks to the lever seal replacing screws and to its internal design, every part can be easily removed and repositioned without the use of special tools.

Co-injected gaskets: OTTIMA is manufactured on a production line that employs management and technology criteria market leading. All seals, spring sheets, lids and couplings are manufactured through direct co-injection. This means that the seals are moulded directly onto the specific part. Therefore, numerous parts are eliminated, water-tightness is increased, maintenance and installation are eased (no gaskets must be removed and remounted, thus eliminating assembly errors).

Stable base: OTTIMA rests on a stable base that facilitates installation and level check operations. But also helps in maintenance, allowing for a stable support.

Detachable locking lever: the locking lever is detachable. This is an important feature for installation in public-accessible areas to avoid unauthorized tampering or unwanted actuation. Should the lever be lost, the valve can be locked with a monkey wrench thanks to the hexagonal shape of the mechanism rotational axis. Setting the locking lever in sealed position is fundamental during emergencies that require line cut-off. E.g. downstream maintenance, accidental spillage into sewers. Actuation is confirmed by the "click" sound when locked into place.

Minimum offset (7mm) thanks to the low off-set, pipe slope remains unchanged, both before and after installation.



Double flaps

OTTIMA is a Type 2 non-return valve (definition according to standard EN13564), meaning that it is fitted with two automatic protection devices against backflow and with a command seal device. This means double protection in case of backflow and greater guarantee of water-tightness.

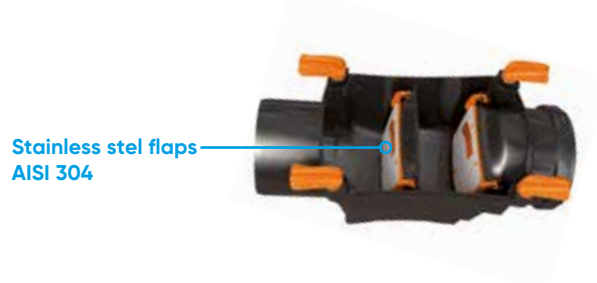

Stainless stel flaps
AISI 304

Advice on installation

The non-return valve can be installed both indoors and outside; the installation that allows easy inspection, inside an accessible recess, an inspection pit, or in sight installation on a pipeline with support brackets, is always recommended. Example of indoor installation: in areas such as cellars, washrooms and basements.

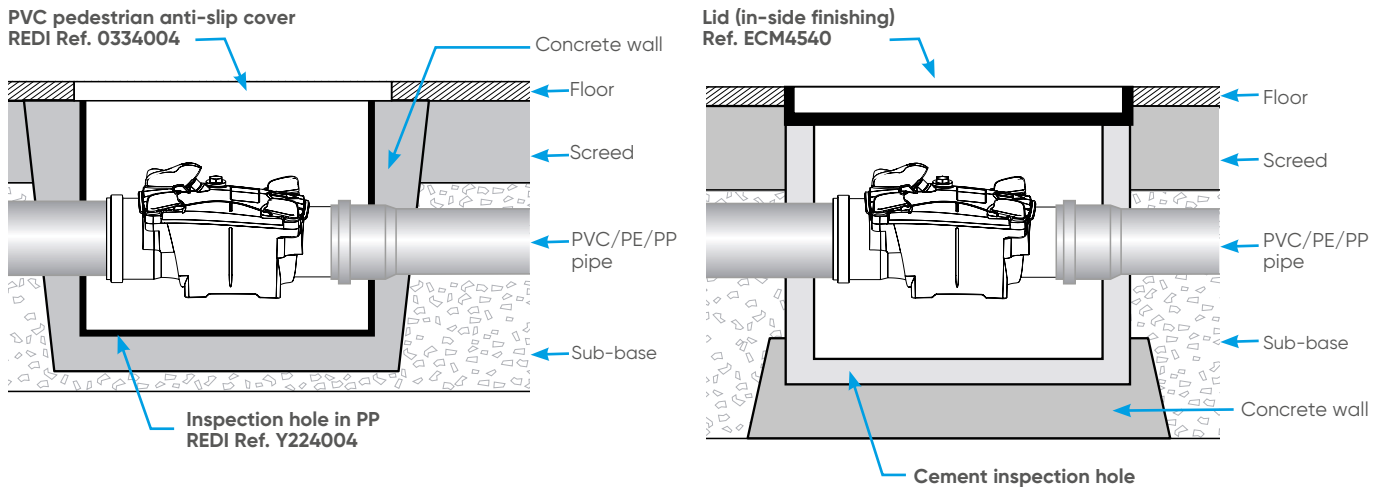

Examples of installation on an overhead pipeline.

The quota in the examples refer to applications with OTTIMA Ø100-110, which are greater for Ø125-160.

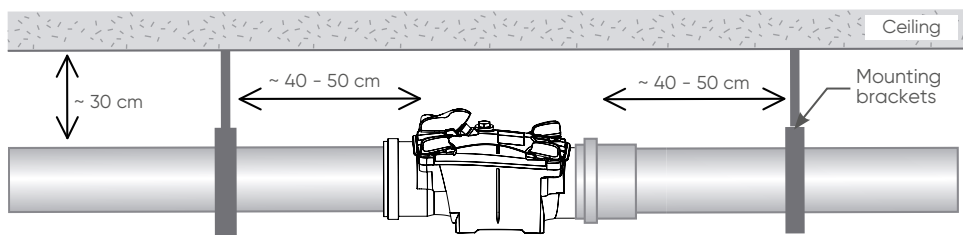

INSTALLATION TYPE

Case 1: Home

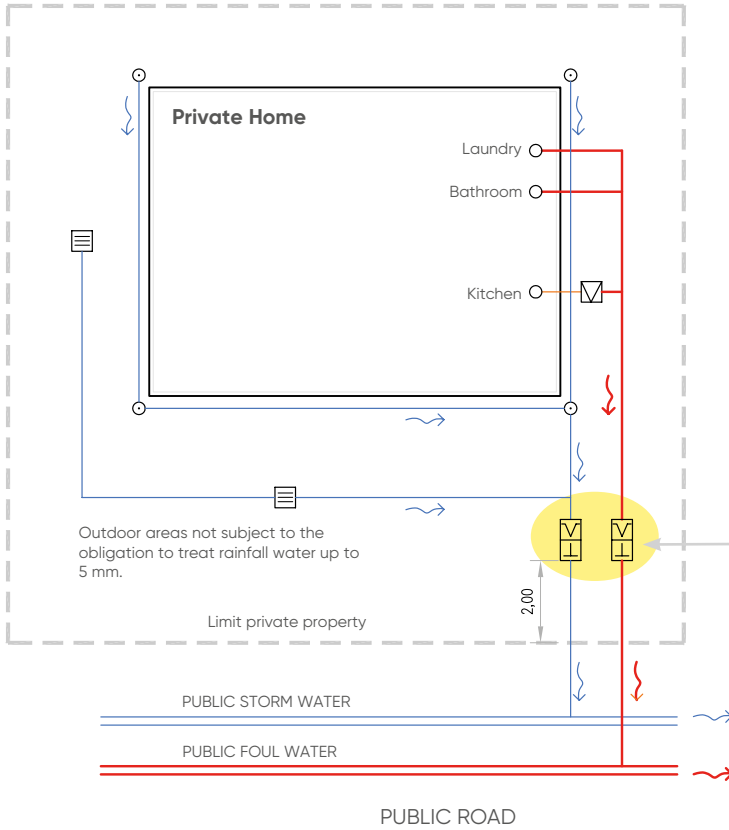

Two examples of non-return valve installation are provided according to Italian laws in force. The first one shows installation in a private home, the second on a production site. The non-return valve must be installed both on the storm and foul water circuits.

Case 2: Industrial site

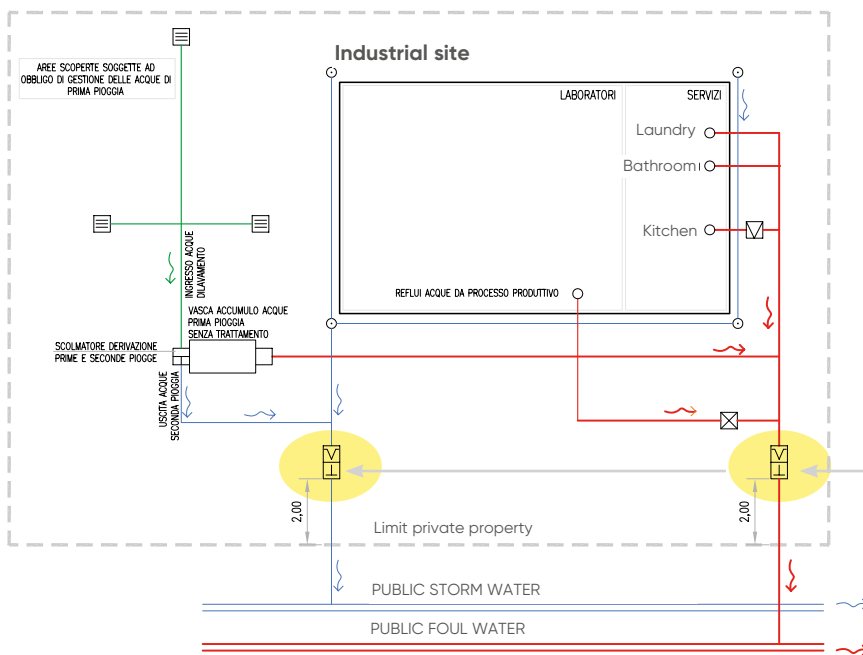

The drawings shown give example of installation in compliance with the most common european standard norms. Regulations may vary according to State and local areas.

Certification

Redi anti-flooding valves DN 100 ÷ 200 are certified by the German Institute LGA (LGA Kitemark).

Certified anti-flooding valves guarantee the following performance levels:

- Regular flow granted by the opening of the flap, even in presence of minimum pressure rates (0.005 bar).
- Non-deformability and tightness of the product after 600 test cycles at variable temperature (60 seconds at 75° / 60 seconds at 15°).
- Effectiveness of Redi anti-flooding device after 35 cycles of backflow of variable duration from 5 up to 10 minutes and pressure rate from 0,01 up to 0.5 bar.
- Water tightness of the entire valve's body, subject to a pressure rate of 0.5 bar.
- Inlet and outlet of the valves are complying with EN1401 and EN1329.

CE¹¹ EN13564: 2002
Antiflooding device made of PVC-U

- Tested features:
- Air proof
 - Water proof
 - Effectiveness test
 - Thermal resistance
 - Mechanical resistance
 - Durability



OTTIMA



CLASSICA

The certificates shown on this catalogue may be subject to revisions and updates. Updated certificates for each product are available on website www.aliaxis.it

Product specifications

OTTIMA - Non-return valve Type 2 - (Type 1)

Twin flaps (or single flap) self-closing non-return valve provided with an emergency locking lever.

The device is CE marked, according to the norm EN13564-1 (LGA). Structure and body of the valve are injected in PVC-U.

Joint dimensions are in compliance with EN1401 and EN1329 norms.

The connection to the main can be effected as follows:

- solvent cement
 - push-fit with rubber ring
 - spigot/spigot with multi-material connectors.
- Rubber seals are certified in accordance with the European norm EN681.

By removing the cover of the valve, the structure can be completely inspected. The co-injected seals on the cover (not removable) guarantee the leakage-tightness.

The valve can be assembled and disassembled without using any tool (such as screwdrivers or spanners).

The valve is manufactured to be installed as recommended in EN12056 norm (Installation and testing, instructions for operation, maintenance and use of Waste-water drainage systems).

Recommended maintenance

According to EN12056, the valve shall be inspected every 6 months by following the inspection procedure:

- remove the cover
- check gaskets conditions
- remove any sludge or debris which could hinder the correct functioning of the device by obstructing the flaps
- lock and unlock the flaps using the locking lever
- assemble and lock the cover again.

Spare parts available on request.

CLASSICA - Non-return valve

Injection-molded non-return valve made of PVC-U, designed for connections to piping systems conform to EN1329 and EN1401.

- One-flap device with locking lever certified EN13564 Type 1.
- SCJ or RRJ jointing type (Sealing lip-rings conform to EN681-1 and DIN4060).
- Moving parts shall either be detachable or capable of being dismantled on site.
- Airtight and watertight sealed cover.
- CE marking.
- German certification LGA EN13564-1 (DN100 up to DN200)

Suppliers will have to attest that they hold a ISO9001 approved quality system in place as a condition for purchase.

NON-RETURN VALVE EN13564-1

	N° flaps	Emergency closing	Free	Max Temp.	Tightness	Installation	Features
Type 0 	1	NO	90%	75 C°	0,5 bar	horizontal pipe	Equipped with one automatic closing device. Single flap.
Type 1 	1	SI	90%	75 C°	0,5 bar	horizontal pipe	Equipped with one automatic closing device. Single flap. Furthermore it has an emergency closing handle, that can be combined to the flap.
Type 2 	2	SI	90%	75 C°	0,5 bar	horizontal pipe	Equipped with two automatic closing devices. Twin flaps. The emergency closing handle, can be combined with one of both flaps.



OTTIMA TECHNICAL REQUIREMENTS

OTTIMA	Ø100	Ø110	Ø125	Ø160
Valve Type	TYPE 1 TYPE 2	TYPE 1 TYPE 2	TYPE 1 TYPE 2	TYPE 1 TYPE 2
Material	U-PVC	U-PVC	U-PVC	U-PVC
EN1401-1329 compliance	OK	OK	OK	OK
Connection type	Glue - M/F - F/F	Glue - M/F - F/F	Glue - M/F - F/F	Glue - M/F - F/F
Fully inspectable	OK	OK	OK	OK
Cover tightness	OK	OK	OK	OK
Removable flap	OK	OK	OK	OK
EN681-1 Seal	OK	OK	OK	OK
EN13564-1	OK	OK	OK	OK
Hot/cold test	OK	OK	OK	OK
Flap tightness	OK	OK	OK	OK
LGA TEST	OK	OK	OK	OK
CE Mark	OK	OK	OK	OK

TYPE 2

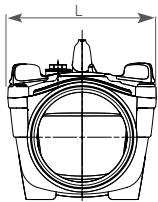
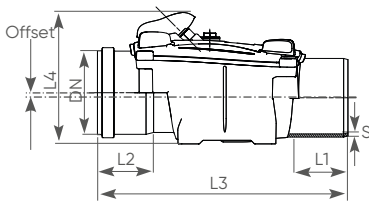

Single Socket - RRJ - All plastic smooth materials ØOD
Clapet anti-retour en PVC injecté M/F à joint, 2 clapets
Válvula anti-retorno M/H con junta labiada, clapeta doble



DN (mm)	Reference Black			S (mm)	L (mm)	L1 (mm)	L2 (mm)	L3 (mm)	L4 (mm)	Offset (mm)	Note
100	12R1048	1	60	3,0	171	60	57	338	184	7	
110	12R1148	1	60	3,2	171	65	63	350	184	7	
125	12R1248	1	24	3,2	255	73	69	458	226	9	
160	12R1648	1	24	4,0	255	83	82	491	226	9	

Stainless steel flap AISI 304 Lip Ring

TYPE 1

Single Socket - RRJ - All plastic smooth materials ØOD
Clapet anti-retour en PVC injecté M/F à joint, 1 clapet
Válvula anti-retorno M/H con junta labiada, clapeta única

DN (mm)	Reference Black			S (mm)	L (mm)	L1 (mm)	L2 (mm)	L3 (mm)	L4 (mm)	Offset (mm)	Note
100	11R1048	1	60	3,0	171	60	57	338	184	7	
110	11R1148	1	60	3,2	171	65	63	350	184	7	
125	11R1248	1	24	3,2	255	73	69	458	226	9	
160	11R1648	1	24	4,0	255	83	82	491	226	9	

Stainless steel flap AISI 304 Lip Ring



Lip seal version, we recommend to lubricate the gasket to make installation easier



SOLVENT CEMENT transition fitting



TYPE 2

Single Socket - SCJ - PVC

Clapet anti-retour en PVC injecté M/F à coller, 2 clapets
Válvula anti-retorno M/H para encolar, clapeta doble

DN (mm)	Reference Black			S (mm)	L (mm)	L1 (mm)	L2 (mm)	L3 (mm)	L4 (mm)	Offset (mm)	Note
100	12S1008	1	60	3,0	171	60	53	334	184	7	
110	12S1108*	1	60	3,2	171	65	63	350	184	7	
125	12S1208	1	24	3,2	255	73	69	458	226	9	
160	12S1608	1	24	4,0	255	83	82	491	226	9	

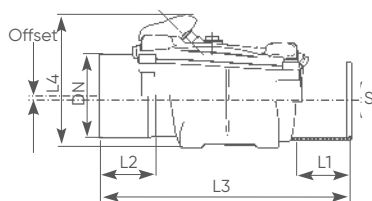

*upon request

Stainless steel flap AISI 304

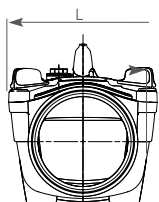

TYPE 1

Single Socket - SCJ - PVC

Clapet anti-retour en PVC injecté M/F à coller, 1 clapet
Válvula anti-retorno M/H para encolar, clapeta única

DN (mm)	Reference Black			S (mm)	L (mm)	L1 (mm)	L2 (mm)	L3 (mm)	L4 (mm)	Offset (mm)	Note
100	11S1008	1	60	3,0	171	60	53	334	184	7	
110	11S1108*	1	60	3,2	171	65	63	350	184	7	
125	11S1208	1	24	3,2	255	73	69	458	226	9	
160	11S1608	1	24	4,0	255	83	82	491	226	9	

*upon request

Stainless steel flap AISI 304



Solvent cement - Colle - Adhesivo

Pack	Gr.	Reference
Tube	125	COLLA12
Jar	250	COLLA25
Jar	500	COLLA50
Jar	1.000	COLLA00



TYPE 1

Non-return valve

Clapet anti-retour - Válvula anti-retorno

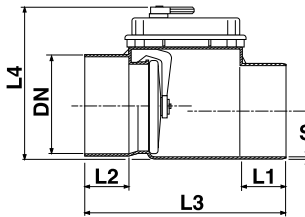
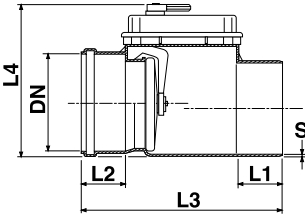

DN (mm)	S (mm)	L1 (mm)	L2 (mm)	L3 (mm)	L4 (mm)	Reference RAL 8023 Red			Note
100	4.0	58	56	300	230	1555052*	1	56	With Lip-ring
110	4.0	61	61	307	230	1555551	1	56	With Lip-ring
125	4.0	68	65	318	230	1556051	1	56	With Lip-ring
160	4.0	74	74	337	255	1551691	1	30	With Lip-ring
200	4.5	100	86	451	300	1552091	1	24	With Lip-ring

100	4.0	58	56	300	230	1555001	1	56	Solvent cement socket
110	4.0	61	61	307	230	1555501	1	56	Solvent cement socket
125	4.0	68	65	318	230	1556001	1	56	Solvent cement socket
140	4.0	69	65	325	255	1551401	1	30	Solvent cement socket
160	4.0	74	74	337	255	1551601	1	30	Solvent cement socket
200	4.5	100	86	451	300	1552001	1	24	Solvent cement socket

* Grey colour Lip Ring



TYPE 1

Non-return valve stainless steel flap

Clapet anti-retour - Válvula anti-retorno con clapeta de acero inox



Stainless steel flap AISI 304

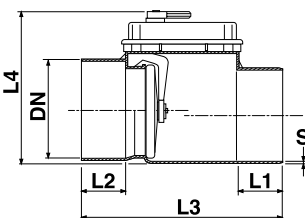
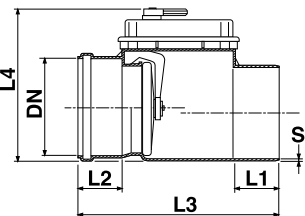

DN (mm)	S (mm)	L1 (mm)	L2 (mm)	L3 (mm)	L4 (mm)	Reference RAL 8023 Red			Note
110	4.0	61	61	307	230	1555651	1	56	With Lip-ring
125	4.0	68	65	318	230	1556151	1	56	With Lip-ring
160	4.0	74	74	337	255	1551791	1	30	With Lip-ring

100	4.0	61	57	300	230	1555101	1	56	Solvent cement socket
110	4.0	61	61	307	230	1555601	1	56	Solvent cement socket
140	4.0	69	65	325	255	1551501	1	30	Solvent cement socket
160	4.0	74	74	337	255	1551701	1	30	Solvent cement socket

Stainless steel flap AISI 304 Lip Ring

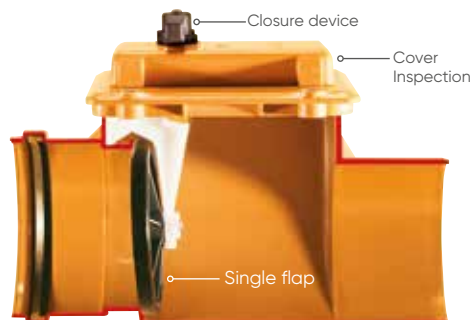



Non-return valve

Clapet anti-retour - Válvula anti-retorno

DN (mm)	S (mm)	L1 (mm)	L2 (mm)	L3 (mm)	L4 (mm)	Reference RAL 8023 Red			Note
250	6.2	130	102	520	374	1552591	1	12	With Lip-ring
315	7.7	160	125	615	440	1553091	1	8	With Lip-ring

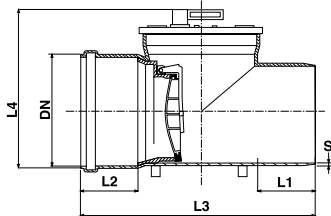

250	6.2	130	102	520	374	1552501	1	12	Solvent cement socket
315	7.7	160	125	615	440	1553001*	1	8	Solvent cement socket

*upon request Lip Ring DOP available

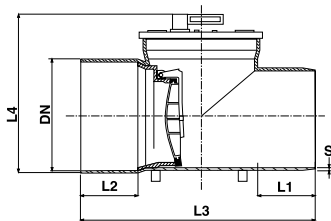

Non-return valve without emergency closure device

Clapet anti-retour sans levier de verouillage

Válvula anti-retorno sin palanca de cierre

DN (mm)	S (mm)	L1 (mm)	L2 (mm)	L3 (mm)	L4 (mm)	Reference RAL 8023 Red			Note
400	9.8	245	140	800	480	1554091	1	4	With Lip-ring

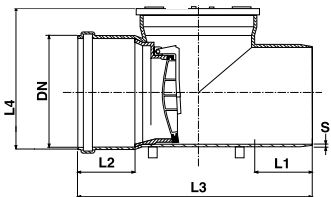

Lip Ring DOP available



Non-return valve senza leva di blocco
Clapet anti-retour without emergency closure device
Válvula anti-retorno sin palanca de cierre

DN (mm)	H (mm)	L1 (mm)	L2 (mm)	L3 (mm)	Reference RAL 8023 Red + black	SN			Note
500	645	1100	460	260	T555191	SN4*	1	1	With Lip-ring
630	775	1300	460	260	T556391	SN4*	1	1	With Lip-ring

* the article is fabricated by using PVC pipe SN4 conform to EN1401
 Male/Male version available on request

Lip Ring

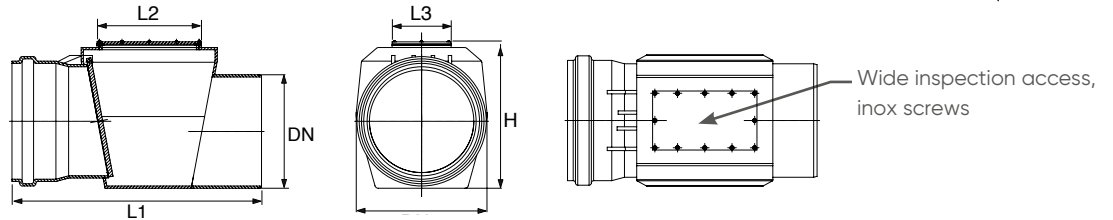

TYPE 0



Non-return valve without emergency closure device
Clapet anti-retour - Válvula anti-retorno

DN (mm)	L3 (mm)	L4 (mm)	CN1 (mm)	L3S (mm)	Reference RAL 8023 Red			Riser	Note
110	280	170	154	20	NC879E1*	1	90	PVC pipe Ø160 SN2 EN1401	Plastic flap
125	290	170	154	20	NC887E1*	1	90	PVC pipe Ø160 SN2 EN1401	Plastic flap
160	396	257	236	25	NC919E1*	1	24	PVC pipe Ø200 SN2 EN1401	Plastic flap

*upon request Lip Ring

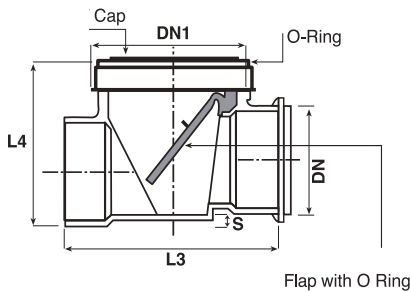

O'RING GASKET guarantees an hermetic seal



Type"0" cap with spirit level for a correct installation.

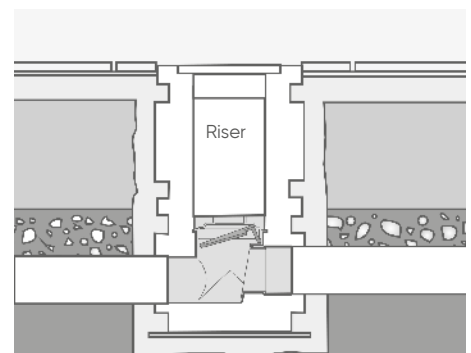

Spare parts - Pièces de rechang - Repuestos



Valve flap Clapet - Clapeta

DN (mm)	Reference			Note
100	1572206	1	960	PVC
110				PVC
125				PVC
100	15722IX	1	1.200	INOX
110				INOX
125				INOX
140	1573306	1	480	PVC
140	15722IX	1	1.200	INOX
160	1573306	1	480	PVC
160	15716IX	1	960	INOX
200	1574406	1	500	PVC
250				PVC
315	1576606	1	-	PVC
400	1577708	1	-	PVC

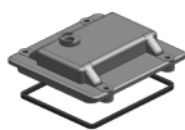

Inspection cover Couverture - Tapa

DN (mm)	Reference			Note
100	1562201*	1	720	
110				
125				
140	1563301*	1	400	
160				
200	1564401*	1	200	
250	1565501	1	96	
315	1566601	1	-	
400	16530T1*	1	-	*upon request



Locking lever Levier - Maneta

DN (mm)	Reference			Note
100	1582208	1	-	
110				
125				
140	1583308*	1	15.600	
160				
200	1582208	1	-	
250	1585501*	1	810	
315				

*upon request



Flap + support Kit clapet - Kit clapeta

DN (mm)	Reference			Note
100-110	1SP1100	1	1.040	
125-160	1SP1600	1	360	

Kit with locking levers Kit de levier de verouillage Maneta + 4 bloqueos

Reference			Note
1KLMA00*	1	810	

*upon request



Inspection cover with lever Couverture avec levier Tapa registro con bloqueos

DN (mm)	Reference			Note
100-110	1CO1100	1	-	
125-160	1CO1600	1	100	



FLAP VALVE



Type A INOX FLAP

The flap valves allow the waste water to flow out from a pipe to either a ditch or a pond, preventing back flooding at the same time. The flap is opened by waste water's thrust. Flap's weight and 11° slant keep the device closed when not working.

- Material: PVC-U complying to EN1401.

- Colour: Red RAL 8023 (body) Grey (flap).
- Flap seal, EPDM + CR closed cell expanded rubber.
- Hinge: stainless steel AISI 304 with self locking nut.
- Flap closure tilt 11°.
- Up Ø 200 supplied in carton box.

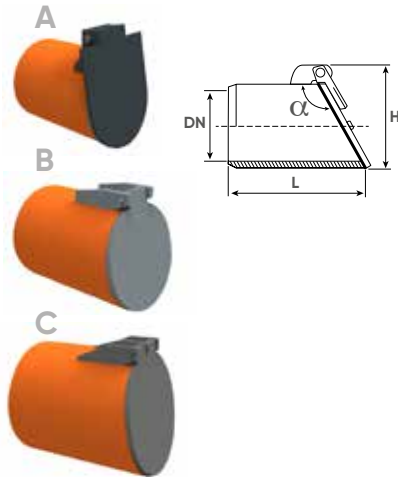

Flap valve, spigot connection

Clapet de nez - Válvula de clapeta macho

DN (mm)	Reference			L (mm)	H (mm)	α	Type	RAL Body	Flap
110	P5510M1	1	210	145	140	11°	A	RAL 8023	INOX
125	P5512M1	1	96	165	155	11°	A	RAL 8023	INOX
160	P5516M1	1	84	180	190	11°	A	RAL 8023	INOX
200	P5520M1	1	48	205	230	11°	A	RAL 8023	INOX
250	P5525M1	1	24	260	280	11°	B	RAL 8023	
315	P5530M1	1	8	300	350	11°	B	RAL 8023	
400	P5540M1	1	8	350	430	11°	C	RAL 8023	
500	P5550M1*	1	4	400	530	11°	C	RAL 8023	
630	P5563M1*	1	-	500	660	11°	C	RAL 8023	

*upon request

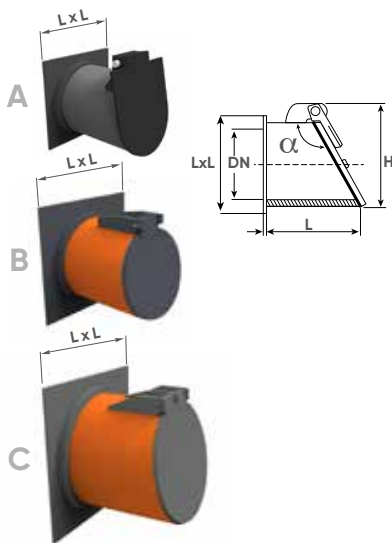

Flap valve, flanged connection

Clapet de nez - Válvula de clapeta brida

DN (mm)	LxL (mm)	Reference			L (mm)	H (mm)	S (mm)	α	Type	RAL Body	Flap
110	160	P551002	1	175	145	140	5	11°	A	RAL 7037	INOX
125	160	P551202	1	100	165	155	5	11°	A	RAL 7037	INOX
160	199	P551602	1	96	180	190	5	11°	A	RAL 7037	INOX
200	250	P552002	1	36	205	230	5	11°	A	RAL 7037	INOX
250	320	P552501	1	24	260	280	5	11°	B	RAL 8023	
315	370	P553001	1	18	300	350	6	11°	B	RAL 8023	
400	480	P554001	1	1	350	430	8	11°	C	RAL 8023	
500	600	P555001	1	10	400	530	10	11°	C	RAL 8023	
630	730	P556301	1	-	500	660	12	11°	C	RAL 8023	

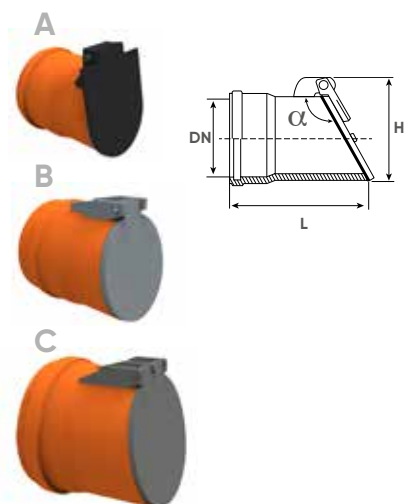



Flap valve, socket connection

Clapet de nez - Válvula de clapeta hembra

DN (mm)	Reference			L (mm)	H (mm)	α	Type	RAL Body	Flap
110	P5510F1	1	210	145	140	11°	A	RAL 8023	INOX
125	P5512F1	1	96	165	155	11°	A	RAL 8023	INOX
160	P5516F1	1	84	180	190	11°	A	RAL 8023	INOX
200	P5520F1	1	48	205	230	11°	A	RAL 8023	INOX
250	P5525F1	1	33	260	280	11°	B	RAL 8023	
315	P5530F1	1	20	300	350	11°	B	RAL 8023	
400	P5540F1	1	8	350	430	11°	C	RAL 8023	
500	P5550F1	1	4	400	530	11°	C	RAL 8023	
630	P5563F1	1	2	500	660	11°	C	RAL 8023	

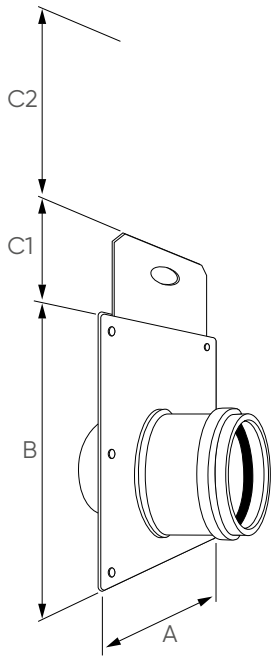
Guillotine valve Clapet guillotine - Válvula de guillotina



DN (mm)	Reference			A (mm)	B (mm)	C1 (mm)	C2 (mm)	Note
110	P5510G1	1	-	172	300	74	110	
125	P5512G1	1	-	194	311	82	142	
160	P5516G1	1	-	225	335	95	180	
200	P5520G1	1	-	264	374	100	219	
250	P5525G1	1	-	330	430	110	250	
315	P5530G1	1	-	425	540	115	340	
400	P5540G1	1	-	510	583	110	450	

Material: PVC-U

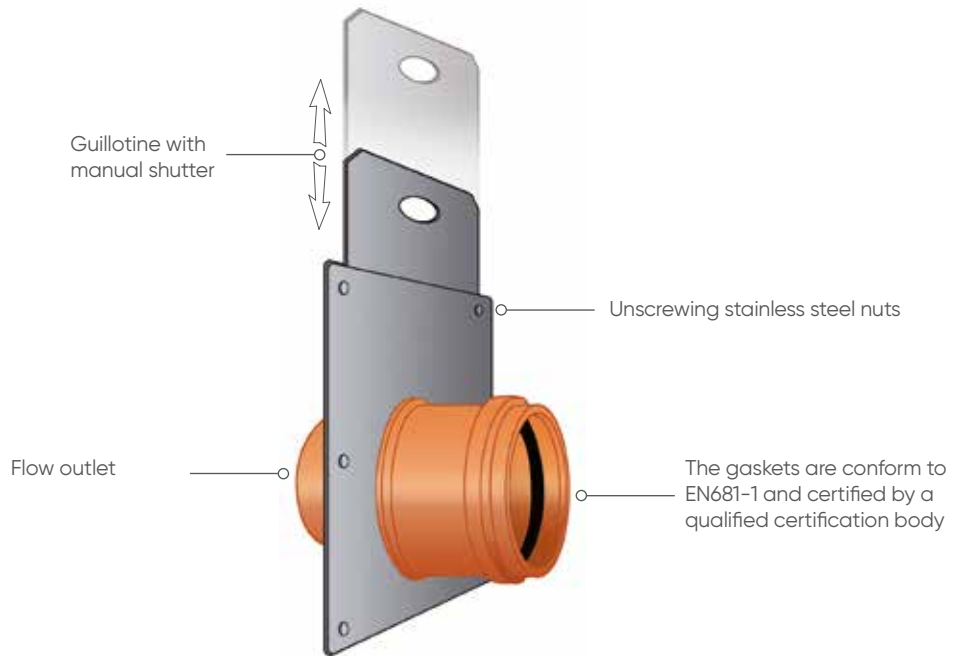

EASY CLIP

Special Mechanical Saddle Connections

EASY CLIP



3.2 MECHANICAL SADDLES

Full Special Saddle Range for
Pipe-Connection Applications
PVC-U Solvent Welded Clamp
Saddle Fittings

aliaxis

EASY CLIP

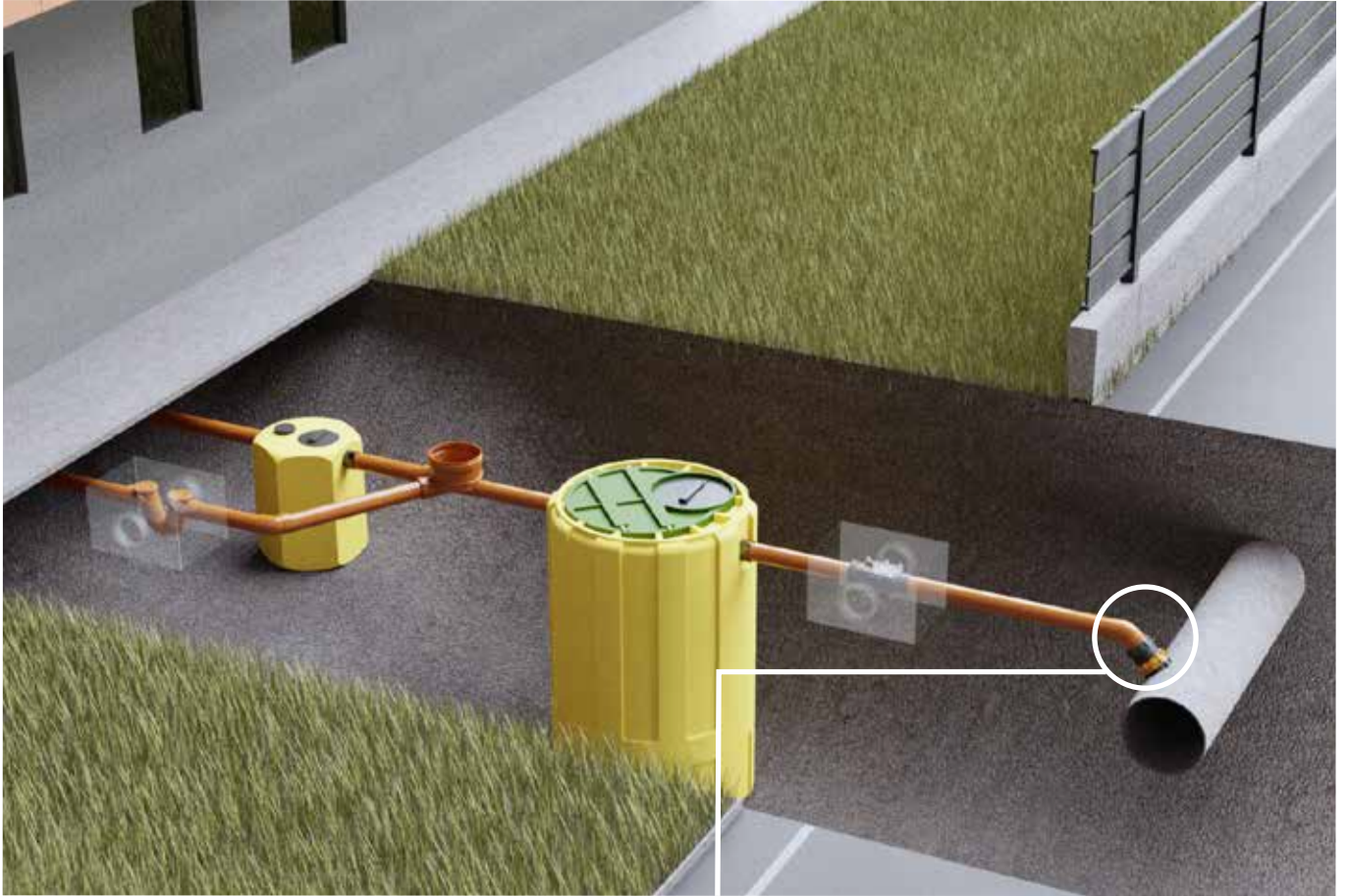

City 	Plus 	Link 	Tech 
 <p>Ø160</p>	 <p>Ø160 Spherical joint</p>	 <p>Ø160 Ø200</p>	 <p>Ø160</p>
 <p>OD 200÷400</p>	 <p>OD 315÷1000</p>	 <p>OD 315÷1000</p>	 <p>DN 250-300-350</p>
 <p>DN ID 250*</p>	 <p>DN 300÷1200</p>	 <p>DN 300÷1200</p>	 <p>DN 250-300</p>
 <p>DN 200÷250</p>	 <p>DN 300÷1200</p>	 <p>DN 300÷1200</p>	
<p>For pipes with small diameters *≥SN8 complying with EN 13476</p>	<p>For all materials, large diameters, absorbs the soil movements</p>	<p>For all materials, large diameters</p>	<p>For Concrete and Clay pipes, for hard cleaning</p>

Special Mechanical Connections

Easy Clip special mechanical saddles are products that provide the pipeline connection, without using any type of adhesives or solvent cements. They are particularly suitable for:

New Installations:

They carry out a lateral connection to the new-set-up drain or sewer system.

Preexisting Pipelines:

They allow the creation of a new connection to a preexisting drain or sewer system.

Easy Clip range is suitable for both waste and surface water.

The 4 different product models is designed to suit different types of installation.



City

For smaller diameter pipes

Designed for Plastic compact solid wall pipes PVC/PP/PE Ø200-250-315-400. Vitrified Clay pipes Ø200, Ø250. Structured wall (smooth inside) pipes ID 250. Hole saw Ø152 mm. Socket rubber ring Ø160 mm.



Plus

For large diameter pipes

Suitable for any material pipe (plastic compact solid wall, plastic structured wall and smooth inside, concrete). From Ø300 up to Ø1200. Spherical joint (swivel) compensates ground movements. Socket Ø160 rubber ring.



Link

For large diameter pipes

Suitable for any material pipe (compact solid wall, structured wall smooth inside, concrete). From Ø300 up to Ø1200. Either Ø160 or Ø200 socket rubber ring.



Tech

Thick walled concrete & clay pipes

Designed for thick walled concrete and clay pipes Ø250-350. No internal gaps and resistant to "hard cleaning cycles" (e.g. chains, blades, or high pressure water jetting).

An alternative working method

With traditional collar-type systems, the main difficulty lies in removing the material beneath the existing pipeline. The Easy Clip Connections provide for a completely different and more professional working methodology.

The main advantages of using a mechanical connection can be summarized in the following points:

- Major reduction of the time required for excavating and backfilling existing pipelines
- Speed of installation
- Installation without the use of sealants
- Ease of installation
- Low overall installation costs
- Guaranteed joint security
- Flexible solutions

Obviously, the pipeline does not have to be "supported", as is the case with traditional collar-type alternatives. The device's mechanical anchoring system simplifies the operation and drastically reduces the installation time.

Safety: curing times are not required (as there is no use of cement or adhesives) and the excavation can be immediately backfilled once the intervention has

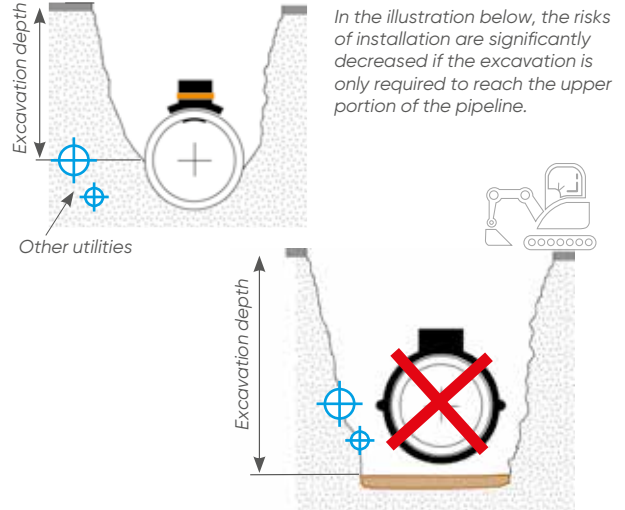
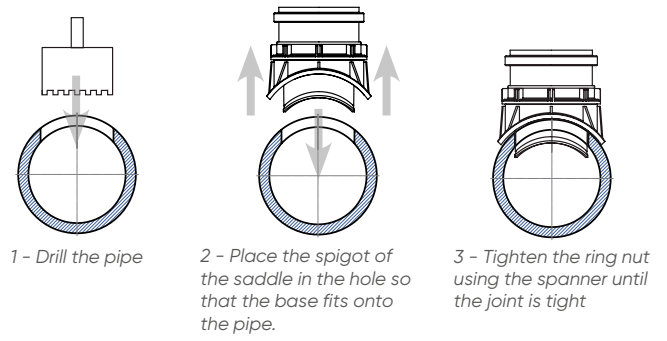

been completed. For this reason, there is no need to leave the excavation open on roads, pathways or residential areas. Therefore there is no need for the work site to be monitored or cordoned off in order to prevent any potential accidents, thus providing significant savings.

With mechanical saddle

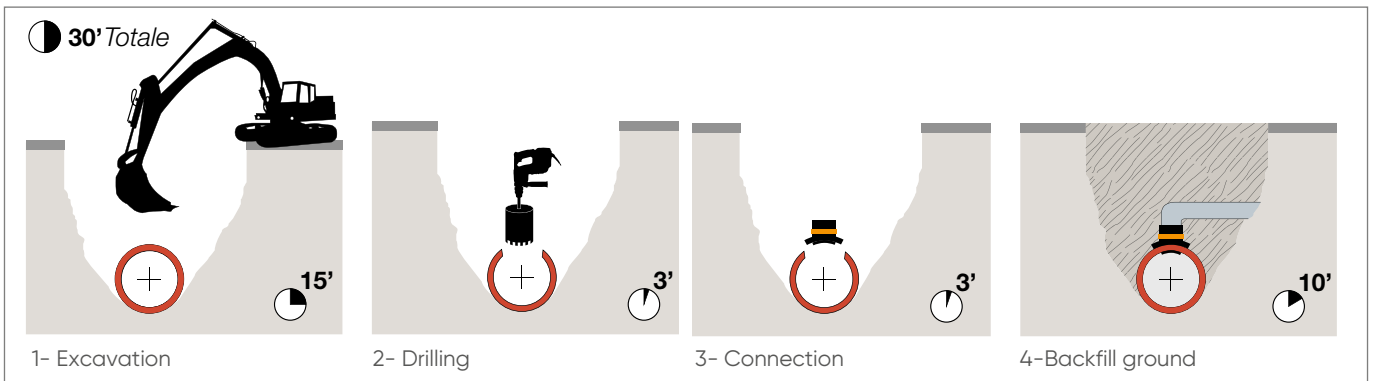

Without mechanical saddle

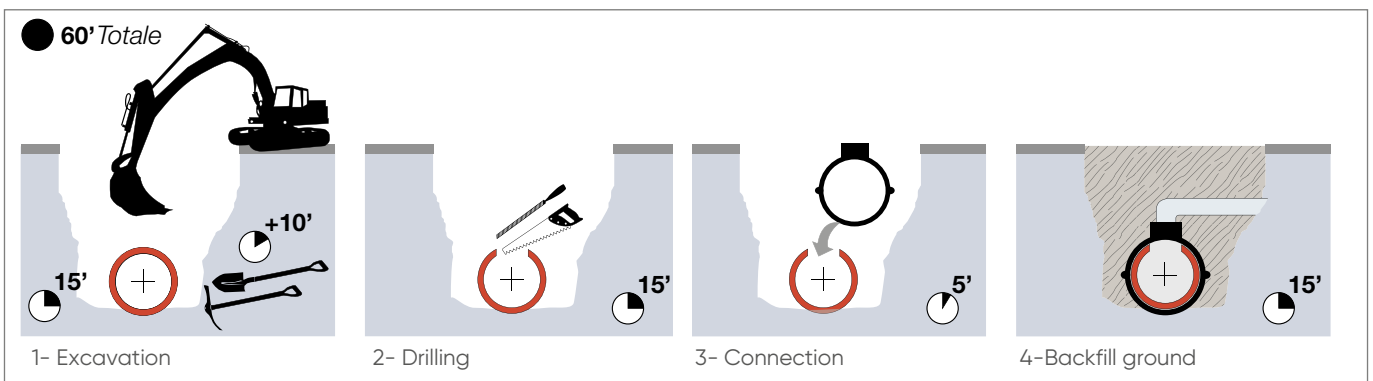

Installation tips:

1. Identify the point at which the connection is required and clean away any debris that may be present.
2. Drill the hole perpendicular to the axis of the main pipe

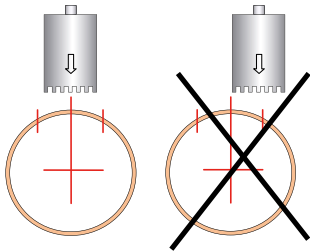

Note:

The use of appropriate equipment for centering the pipe will help to prevent errors during this phase. The installation procedure will not be successful if the hole is performed in a decentralized manner. In the case of non-plastic materials (i.e. ceramic or concrete) it is recommended to drill a guide hole (1) initially before completing the hole using a milling tool with a centring drill bit (2). The drilling procedure should always be carried out using water. In the case of plastic materials, it is best to use a milling tool with an incorporated centring drill bit.

If more than one connection needs to be performed on the same tract of pipe, be sure to leave at least 1 meter between each hole.

The installation conditions must always be assessed on a case by case basis: loads, compactness of the terrain, presence of foundations, vehicular traffic, groundwater, etc.

3. Deburr the edges of the hole using a suitable tool, this is especially important for holes made in plastic materials.
4. Lubricate the seal.
5. Insert the Clip and tighten the ring nut.

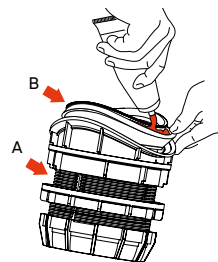

The packaging Easy Clip LINK CITY PLUS include one tube of lubricant gr 150 Art. 6741500

Installation Easy Clip TECH:

Easy Clip tech is supplied with one or two adaptors and a spanner. Choose the right adaptor depending on the installation type. For detailed information concerning installation, please see the "installation sheet" contained in the box.

Fix the right adaptor using the supplied screws. Easy Clip Tech is ready to be installed. i.e. on a concrete pipe.



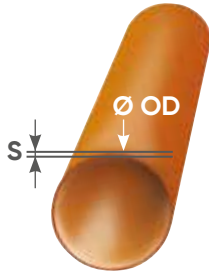

Compact solid wall wall/multilayer smooth plastic pipes OD
Installation tube PVC PP PE lisse epaisseur OD
Instalación tubo liso de pared compacta OD

Pipe Ø OD	200	250	315	400
Easy Clip City Ø160	1431158	1432258	1433358	1434458
S (mm)	3÷9	3÷15	3÷15	3÷18



Installation on PVC/PP/PE compact solid wall pipe OD
Installation tube PVC/PP/PE epaisseur OD
Instalación tubo PVC/PP/PE de espesor compacto OD

DN (mm)	Ø (mm)	S Max Pipe	L1 (mm)	L2 (mm)	Reference	**		Hole saw
200	160	9 mm	255	195	1431158	1	80	AD1513P

** Every clip is individually packed in a plastic wrapper, along with a tube of lubricant and assembly instructions. (lubricant included Art.6741500 gr. 150)
1 spanner included in each box of 6 pcs.

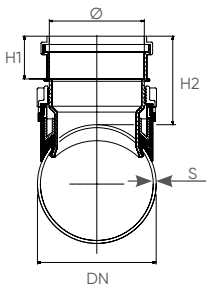

Installation on PVC/PP/PE compact solid wall pipe OD
Installation tube PVC/PP/PE epaisseur OD
Instalación tubo PVC/PP/PE de espesor compacto OD

DN (mm)	Ø (mm)	S Max Pipe	L1 (mm)	L2 (mm)	Reference	**		Hole saw
250	160	15 mm	285	290	1432258	1	48	AD1513P
315	160	15 mm	315	290	1433358	6	48	AD1513P
400	160	18 mm	360	290	1434458	1	48	AD1513P

** Every clip is individually packed in a plastic wrapper, along with a tube of lubricant and assembly instructions. (lubricant included Art.6741500 gr. 150)
1 spanner included in each box of 6 pcs.

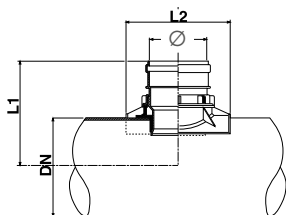

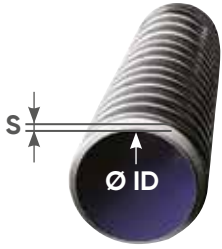

Twin/structured wall plastic pipe ID
Installation tube annelé ID
Instalación tubo corrugado ID

Pipe Ø ID	Ø ID 250
Easy Clip City Ø160	1432658
S (mm)	20÷30



Installation on corrugated pipe ≥SN8 (EN13476)
Installation tube annelé ≥SN8 (EN13476)
Instalación tubo corrugado ≥SN8 (EN13476)

DN ID	Ø	S Max Pipe	L1	L2	L3	Ref.	Box **	Pallet	Hole saw
250	160	20÷35	182	290	236	1432658	1	48	AD1513P

** Every clip is individually packed in a plastic wrapper, along with a tube of lubricant and assembly instructions.
 (lubricant included Art.6741500 gr. 150)
1 spanner included in each box of 6 pcs.

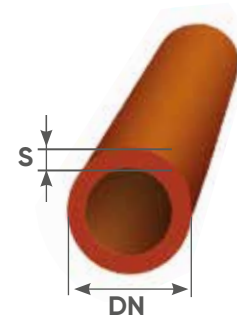
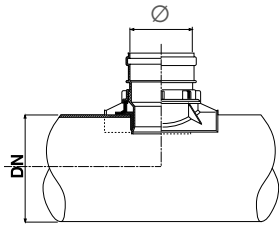

Clay pipe (nominal diameter)
Installation tube grès (diamètre nominal)
Instalación tubo gres (diámetro nominal)

Pipe DN	DN 200	DN 250
Easy Clip City Ø160	1431658	1432658
Thickness Class According to EN 295-1	Class 160 / 240	Class 160 / 240
S (mm)	15÷28	20÷37

Installation on clay pipe (UNI EN 295-1)
Installation tube grès (UNI EN 295-1)
Instalación tubo gres (UNI EN 295-1)

	DN ID	OD	Class	Ø KN/M ²	H (mm)	L1 (mm)	L2 (mm)	L3 (mm)	Ref.	Box **	Pallet	Hole saw
Pipe standard	200	242	160	160	158	194	290	219	1431658	1	48	AC1KSDZ
Pipe standard	200	254	240	160	152							
Pipe standard	250	299	160	160	161	182	290	236	1432658	1	48	AC1KSDZ
Pipe extra	250	318	240	160	151							

** Every clip is individually packed in a plastic wrapper, along with a tube of lubricant and assembly instructions.
 (lubricant included Art.6741500 gr. 150)
1 spanner included in each box of 6 pcs.

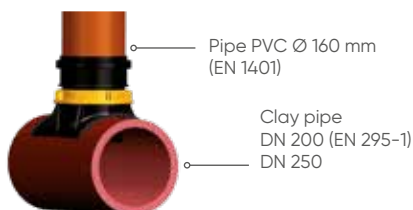
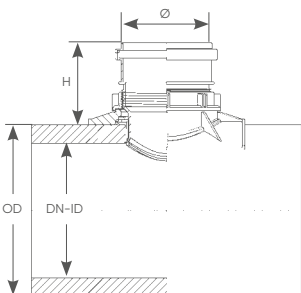

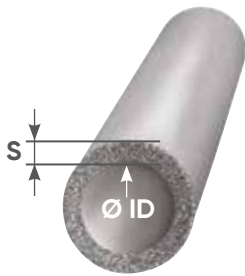

ID = Internal Diameter OD = Outside Diameter S = Wall thickness DN = Nominal Diameter

Plus



Reinforced concrete pipe ID Installation tube en béton ID Instalación tubo hormigón ID

Pipe Ø ID		300	400	500	600	700÷1200
Easy Clip Plus Ø160 with swivel	 	1C16058	1E16058	1H16058	1H16058	1K16058
S (mm)		30÷80	30÷80	40÷100	40÷100	40÷100

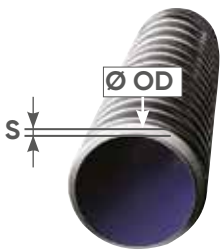

Twin/structured wall plastic pipe OD Installation tube annelé epaisseur OD Instalación tubo corrugado de espesor OD

Pipe Ø OD		315	400	500	630	800÷1000
Easy Clip Plus Ø160 with swivel		1A16058	1D16058	1G16058	1K16058	1K16058
S (mm)		5÷30	6÷35	9÷50	9÷50	20÷100
Easy Clip Plus shorter version Ø160 with swivel		1Y16058	1X16058	Shorter version		
S (mm)		5÷30	6÷35			

Pipe conform to EN13476 ≥ SN8

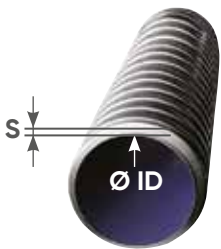



Twin/structured wall plastic pipe ID Installation tube annelé ID Instalación tubo corrugado ID

Tubo / Pipe Ø ID		300	400	500	600	700÷1200
Easy Clip Plus Ø160 with swivel		1A16058	1E16058	1G16058	1H16058	1K16058
S (mm)		5÷30	30-80	20-65	40÷100	40÷100
Easy Clip Plus Ø160 Shorter version with swivel		1Y16058	1Z16058	Shorter version		
S (mm)		5÷30	30÷55			

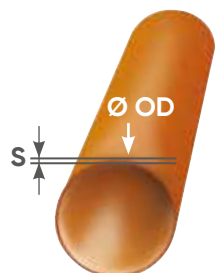
Pipe conform to EN13476 ≥ SN8



GRP compact solid wall wall/multilayer smooth plastic pipe OD Installation tube PVC PP PE PRV lisse epaisseur OD Instalación tubo liso de pared compacta OD

Tubo / Pipe Ø OD		315	400	500÷630	710÷1000
Easy Clip Plus Ø160 with swivel	 	1A16058	1D16058	1G16058	1J16058
S (mm)		5÷30	6÷35	9÷50	10÷60
Easy Clip Plus Ø160 Shorter version with swivel	 	1Y16058	1Z16058	Shorter version	
S (mm)		5÷30	30÷55		



Installation on structured, compact solid wall, clay, concrete and GRP pipe

Installation tube en béton, annelé, lisse

Instalación tubo de hormigón, corrugado, liso de pared compacta



Easy Clip Plus Ø 160 mm

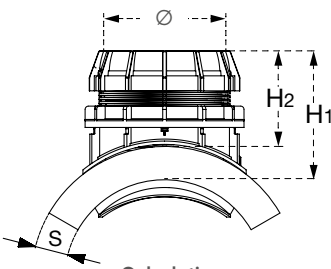

Calculation:
 $H2 = H1 - S (\pm 0,5 \text{ cm})$
 S= wall thickness

Ø (mm)	H1 (mm)	Reference	Certif.	Box**	Pallet	Hole saw
160	255	1A16058	QB MPA	1	38	AD2013P (for plastic)
160	255	1C16058	QB MPA	1	38	AC2CSDZ (for non plastic)
160	255	1D16058	QB MPA	1	38	AD2013P
160	255	1E16058	QB MPA	1	38	AC2CSDZ
160	255	1G16058	QB MPA	1	38	AD2013P
160	255	1H16058	QB MPA	1	38	AD2013P / AC2CSDZ
160	255	1J16058	QB MPA	1	38	AD2013P
160	255	1K16058	QB MPA	1	38	AD2013P / AC2CSDZ
160	205	1X16058*	QB	1	38	AD2013P
160	205	1Y16058	QB MPA	1	38	AD2013P
160	205	1Z16058*	QB	1	38	AD2013P

*upon request

**Every clip is individually packed in a cardboard box, along with a specific spanner, a tube of lubricant and assembly instructions. (lubricant included Art.6741500 gr.150)



AFNOR-CSTB: ANF EN 1401

MPA: DIN EN 13598-1



Swivel joint



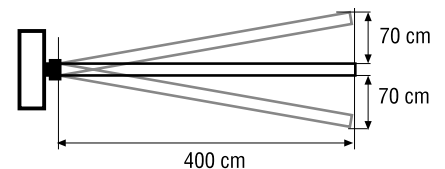
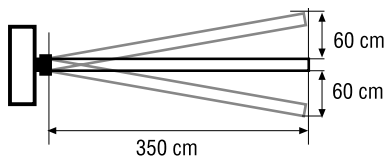
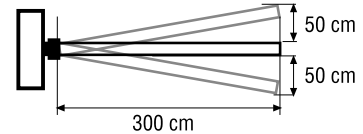
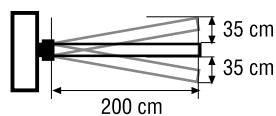

European Patent EP1548349

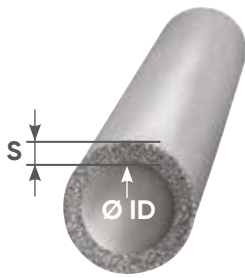

Link



Reinforced concrete and clay pipe ID Installation tube en béton et gres ID Instalación tubo de hormigón o gres ID

Pipe Ø ID		300	400	500	600	700÷1200
Easy Clip Link Ø160	 	1C16L58	1E16L58	1H16L58	1H16L58	1K16L58
S (mm)		30÷80	30÷80	40÷120	40÷120	40÷120
Easy Clip Link Ø200	 	1C20058	1E20058	1H20058	1H20058	1K20058
S (mm)		30÷80	30÷80	40÷100	40÷100	40÷100

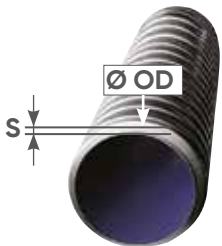

Pipe congorm to
EN13476 ≥ SN8

Twin/structured wall plastic pipe OD Installation tube annelé epaisseur OD Instalación tubo corrugado de espesor OD

Pipe Ø OD		315	400	500÷630	800÷1000
Easy Clip Link Ø160		1A16L58	1D16L58	1G16L58	1K16L58
S (mm)		5÷30	6÷35	9÷50	20÷100
Easy Clip Link Ø200		1A20058	1D20058	1G20058	1K20058
S (mm)		5÷30	6÷35	9÷50	20÷100
Easy Clip Link Ø160		1Y16L58	1X16L58	Shorter version	
S (mm)		5÷30	6÷35		
Easy Clip Link Ø200		1Y20058	1X20058	Shorter version	
S (mm)		5÷30	6÷35		

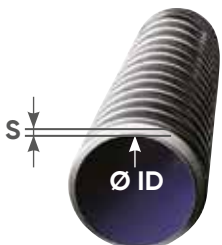



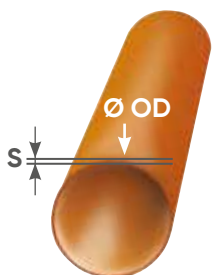

Pipe congorm to
EN13476 ≥ SN8

Twin/structured wall plastic pipe ID Installation tube annelé ID Instalación tubo corrugado ID

Pipe Ø ID		300	400	500	600	700÷1200
Easy Clip Link Ø160		1A16L58	1E16L58	1G16L58	1H16L58	1K16L58
S (mm)		15÷30	30÷80	20÷80	40÷120	40÷120
Easy Clip Link Ø200		1A20058	1E20058	1G20058	1H20058	1K20058
S (mm)		15÷30	30÷80	20÷65	40÷100	40÷100
Easy Clip Link Ø160		1Y16L58	1Z16L58	Shorter version		
S (mm)		15÷30	30÷70			
Easy Clip Link Ø200		1Y20058	1Z20058	Shorter version		
S (mm)		15÷30	30÷55			



Compact solid wall/multilayer smooth plastic pipe OD Installation tube PVC PP PE lisse epaisseur OD Instalación tubo liso de pared compacta OD

Pipe Ø OD		315	400	500÷630	710÷1000
Easy Clip Link Ø160	 	1A16L58	1D16L58	1G16L58	1J16L58
S (mm)		5÷30	6÷35	9÷50	10÷80
Easy Clip Link Ø200	 	1A20058	1D20058	1G20058	1J20058
S (mm)		5÷30	6÷35	9÷50	10÷60
Easy Clip Link Ø160	 	1Y16L58	Shorter version		
S (mm)		5÷30			
Easy Clip Link Ø200	 	1Y20058	Shorter version		
S (mm)		5÷30			

ID = Internal Diameter OD = Outside Diameter S = Wall thickness DN = Nominal Diameter



Link 160

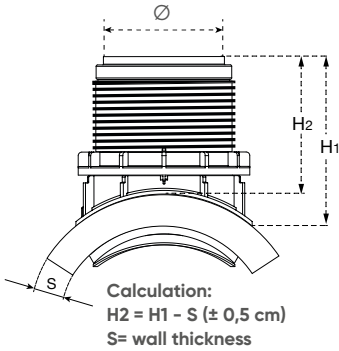

Link 200

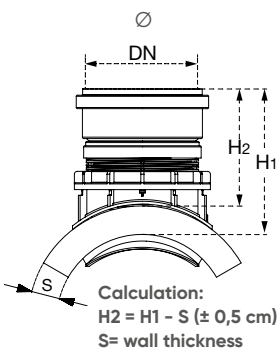

Installation on structured, compact solid wall, clay, concrete and GRP pipe

Installation tube en béton, annelé, lisse

Instalación tubo de hormigón, corrugado, liso de pared compacta

Ø (mm)	H1 (mm)	Reference	Cert.	Box**	Spanner	Hole saw
160	255	1A16L58	QB MPA	1	38	AD2013P (for plastic)
160	255	1C16L58	QB MPA	1	38	AC2CSDZ (for non plastic)
160	255	1D16L58	QB MPA	1	38	AD2013P
160	255	1E16L58	QB MPA	1	38	AC2CSDZ
160	255	1G16L58	QB MPA	1	38	AD2013P
160	255	1H16L58	QB MPA	1	38	AD2013P / AC2CSDZ
160	255	1J16O58	QB MPA	1	38	AD2013P
160	255	1K16L58	QB MPA	1	38	AD2013P / AC2CSDZ
160	205	1X16L58	QB	1	38	AD2013P
160	205	1Y16L58	QB MPA	1	38	AD2013P
160	205	1Z16L58	QB	1	38	AD2013P
200	315	1A20O58	QB MPA	1	38	AD2013P (for plastic)
200	315	1C20O58	QB MPA	1	38	AC2CSDZ (for non plastic)
200	315	1D20O58	QB MPA	1	38	AD2013P
200	315	1E20O58	QB MPA	1	38	AC2CSDZ
200	315	1G20O58	QB MPA	1	38	AD2013P
200	315	1H20O58	QB MPA	1	38	AD2013P / AC2CSDZ
200	315	1J20O58	QB MPA	1	38	AD2013P
200	315	1K20O58	QB MPA	1	38	AD2013P / AC2CSDZ
200	265	1X20O58*	QB	1	38	AD2013P
200	265	1Y20O58	QB MPA	1	38	AD2013P
200	265	1Z20O58	QB	1	38	AD2013P

*upon request

**Every clip is individually packed in a cardboard box, along with a specific spanner, a tube of lubricant and assembly instructions. (lubricant included Art.6741500 gr. 150)



AFNOR-CSTB: ANF EN 1401

MPA: DIN EN 13598-1

3.2 MECHANICAL SADDLES

Tech 

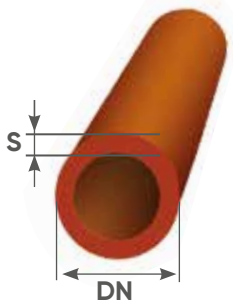

Clay pipe (nominal diameter)

Installation tube grès (diamètre nominal)

Instalación tubo gres (diámetro nominal)

Pipe DN	250	300	350
Clay*	1T21658	1T11658	1T11658
S (mm)	Min. 23	Min. 23	Min. 23

* Dimensions according to the EN295-1

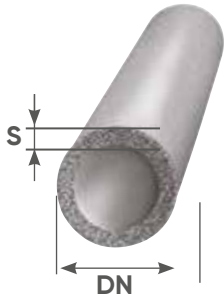

Reinforced concrete pipe (nominal diameter)

Installation tube en béton (diamètre nominal)



Instalación tubo hormigón (diámetro nominal)

Pipe DN	250	300
Concrete	1T11658	1T11658
S (mm)	Min. 23	Min. 23

Installation on Concrete and clay pipe

Installation tube en béton ou grès

Instalación tubo de hormigón o gres



Ø (mm)	H (mm)	Reference			Note
160	260	1T11658*	1	24	
160	260	1T21658*	1	24	

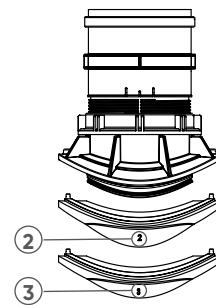
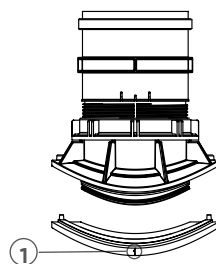
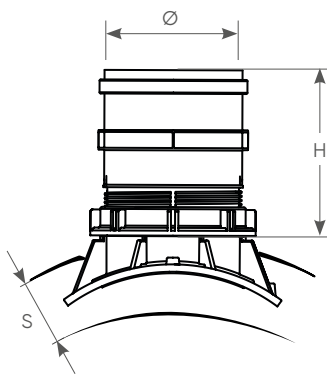

H = Ledge Easy Clip installed on tube
*upon request

Every clip is individually packed in a cardboard box, along with a specific spanner and assembly instructions.

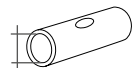
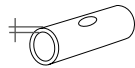

Adaptors

Cod. 1T11658			
			
Clay Grés	DN 300	N - Class 160* H - Class 240*	①
	DN 350	N - Class 160* H - Class 240*	NO
Concrete Beton	DN 250		①
	DN 300		NO

Cod. 1T21658			
			
Clay Grés	DN 250	N - Class 160*	②
	DN 250	H - Class 240*	③

Note:

Designed for concrete and clay pipes DN 250, 300, 350. With high thicknesses. Without internal gaps. Resistant to the sewage "hard cleaning cycles" (e.g. chains, blades, or hi pressur waterjet).

ID = Internal Diameter OD = Outside Diameter S = Wall thickness DN = Nominal Diameter



Compact inverter reducer
Tampon de reducción avec joint
Reducción concéntrica

DN (mm)	DN1 (mm)	DN2 (mm)	H (mm)	H1 (mm)	S (mm)	Reference Block			Note
110	160	166	69.5	57	4	0686348	16	384	

Material: PVC-U
 Gasket: locked preformed EN681
 Dimensions complying EN1401/EN1329

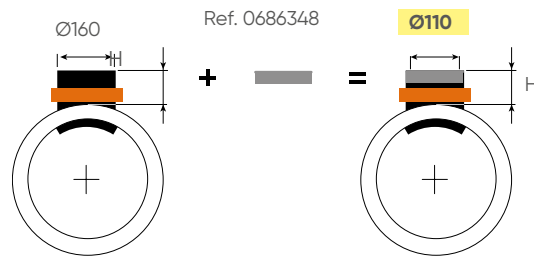
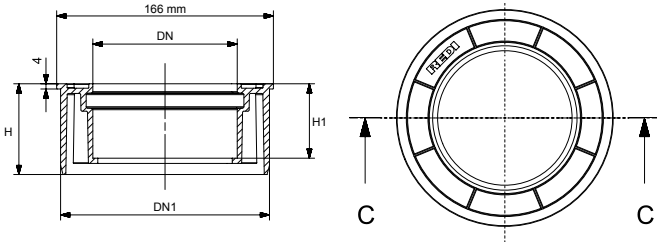

Recommended for installation on Easy Clip City, Link and Tech

Reference
 143ID58
 1432658
 1431658



City

Reference
 1A16L58
 1C16L58
 1D16L58
 1E16L58
 1G16L58
 1H16L58
 1J16L58
 1K16L58
 1X16L58
 1Y16L58
 1Z16L58



Link₁₆₀

Reference
 1T11658
 1T21658



Tech



Not for installation on Easy Clip Plus
Plus

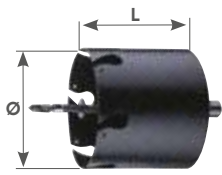

DUSS made in Germany

Hole saw for plastic pipes

Scie cloches pour tubes plastiques PP PE PVC

Corona de corte para tubo de material PLÁSTICO

Ø (mm)	L (mm)	Mandren	Pilot bit	Long endurance	Reference			Note
200	163	13mm	✓	✓	AD2013P	1	52	Pipes from Ø250
152(6")	163	13mm	✓	✓	AD1513P	1	-	Pipes from Ø200

Suitable for drilling materials:
PVC / PP / PE / GRP (sand free)

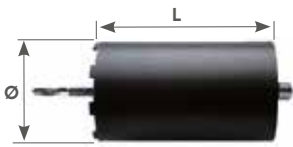

DUSS made in Germany

Hole saw for NON plastic pipes

Scie cloches pour tubes béton ou grès

Corona de corte para tubo de material NO PLÁSTICO

Ø (mm)	L (mm)	Mandren	Pilot bit	Long endurance	Reference			Note
202	300	SDS max	✓	✓	AC2CSDZ	1	8	Pipes from Ø250
152(6")	300	SDS max	✓	✓	AC1KSDZ*	1	-	

Suitable for drilling materials:
Reinforced concrete / Reinforced corrugated steel / Fiber glass filled with sand / Clay

*upon request

Spare parts - Pièces de rechang - Repuestos

Spanner for CITY and TECH

Clé de serrage pour CITY ou TECH

Llave para CITY o TECH



DN (mm)	Reference			Note
160	0996606	1	720	Open

Spanner for PLUS and LINK 160

Clé de serrage pour PLUS ou LINK 160

Llave para PLUS o LINK 160



DN (mm)	Reference			Note
160	0995508	1	400	Closed

Spanner for LINK 200

Clé de serrage pour LINK 200

Llave para LINK 200



DN (mm)	Reference			Note
200	0996008	1	400	Open

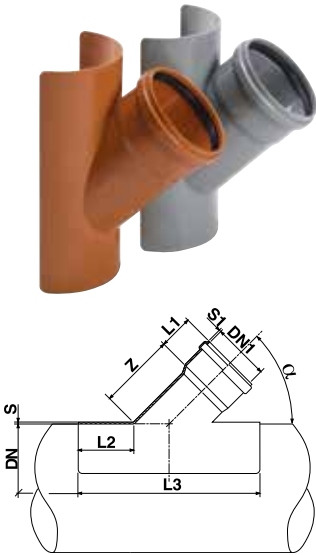

Saddle SCJ 45°
Clip à coller 45° - Injerto 45° con junta labiada

DN (mm)	DN1 (mm)	α	S (mm)	S1 (mm)	Z (mm)	L1 (mm)	L2 (mm)	L3 (mm)	Reference RAL 7037 Grey	Reference RAL 8023 Red		
160	125	45°	3.2	3.0	128	62	65	300	0438042	0438091	15	120
200	125	45°	4.1	3.0	128	62	85	340	0438242	0438291	10	80
200	160	45°	4.1	3.6	165	73	85	390	0438442	0438491	10	60
250	125	45°	5.5	3.0	128	62	92	350	0438642	0438691	10	70
250	160	45°	5.5	3.6	165	73	92	400	0438842	0438891	6	48
315	125	45°	5.5	3.0	128	62	92	350	-	1439091	5	40
315	160	45°	6.9	3.6	165	73	110	432	0439442	0439491	5	30
315	200	45°	6	4.4	236	95	86	513	1433242*	-	-	-
400	125	45°	5.5	3.0	128	62	92	350	-	1439191	5	40
400	160	45°	5.5	3.6	165	73	92	400	-	1439591	3	24
500	125	45°	5.5	3.0	128	62	92	350	1439242*	1439291	-	-
500	160	45°	5.5	3.6	165	73	92	400	-	1439691	3	24

*upon request

Fixed Ring Lip Ring

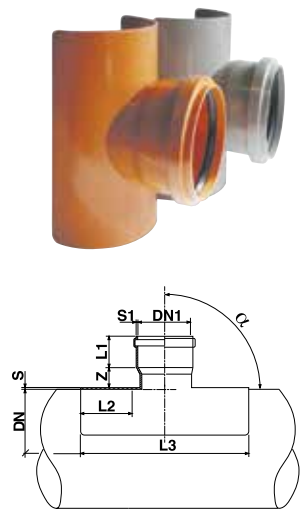

Saddle SCJ 90°
Clip à coller 90° - Injerto 90° con junta labiada

DN (mm)	DN1 (mm)	α	S (mm)	S1 (mm)	Z (mm)	L1 (mm)	L2 (mm)	L3 (mm)	Reference RAL 7037 Grey	Reference RAL 8023 Red		
200	160	90°	4.4	3.6	34	58.5	77	322	-	0434351	10	80
250	160	90°	4.4	3.6	34	58.5	77	322	-	1424251	8	64
315	160	90°	-	-	-	-	-	-	-	142525E	8	64
400	160	90°	-	-	-	-	-	-	-	142625E	7	56

Fixed Ring Lip Ring

Guide to choose the right mechanical saddle

Installation on compact or multilayer smooth plastic pipes OD

Installation tube PVC PP PE lisse epaisseur OD - Instalación tubo liso de pared compacta OD

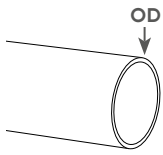

Pipe Ø 200	Pipe Ø 250	Pipe Ø 300	Pipe Ø 315	Pipe Ø 400	Pipe Ø 500	Pipe Ø 600	Pipe Ø 630	Pipe Ø 700	Pipe Ø 710	Pipe Ø 800	Pipe Ø 1000	Pipe Ø 1200	Diam. inlet Easy Clip
1431158 City	1432258 City		1433358 City	1434458 City									Ø 160
			1A16058 Plus	1D16058 Plus	1G16058 Plus					1J16058 Plus			Ø 160
			1Y16058 Plus	1X16058 Plus									Ø 160 Shorter
			1A16L58 Link	1D16L58 Link	1G16L58 Link					1J16L58 Link			Ø 160
			1A20058 Link	1D20058 Link	1G20058 Link					1J20058 Link			Ø 200
			1Y16L58 Link	1X16L58 Link									Ø 160 Shorter
			1Y20058 Link	1X20058 Link									Ø 200 Shorter

Twin/structured wall plastic pipe OD

Installation tube annelé epaisseur OD - Instalación tubo corrugado de espesor OD

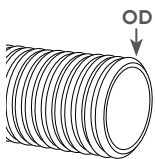

Pipe Ø 200	Pipe Ø 250	Pipe Ø 300	Pipe Ø 315	Pipe Ø 400	Pipe Ø 500	Pipe Ø 600	Pipe Ø 630	Pipe Ø 700	Pipe Ø 710	Pipe Ø 800	Pipe Ø 1000	Pipe Ø 1200	Diam. inlet Easy Clip
			1A16058 Plus	1D16058 Plus	1G16058 Plus		1K16058 Plus			1K16058 Plus			Ø 160
			1A16L58 Link	1D16L58 Link	1G16L58 Link					1K16L58 Link			Ø 160
			1A20058 Link	1D20058 Link	1G20058 Link					1K20058 Link			Ø 200
			1Y16L58 Link	1X16L58 Link									Ø 160 Shorter
			1Y20058 Link	1X20058 Link									Ø 200 Shorter

Reinforced concrete and clay pipe DN

Installation tube en béton et grès DN - Instalación tubo de hormigón o grès DN

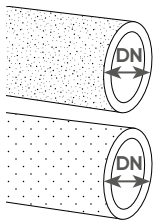

Pipe Ø 200	Pipe Ø 250	Pipe Ø 300	Pipe Ø 315	Pipe Ø 400	Pipe Ø 500	Pipe Ø 600	Pipe Ø 630	Pipe Ø 700	Pipe Ø 710	Pipe Ø 800	Pipe Ø 1000	Pipe Ø 1200	Diam. inlet Easy Clip
1431658 City	1432658 City												Ø 160
	1T21658 Tech	1T11658 Tech											Ø 160
	1T11658 Tech												Ø 160

Reinforced concrete and clay pipe ID

Installation tube en béton et grès ID - Instalación tubo de hormigón o grès ID

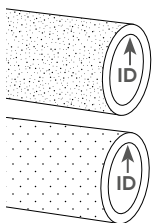

Pipe Ø 200	Pipe Ø 250	Pipe Ø 300	Pipe Ø 315	Pipe Ø 400	Pipe Ø 500	Pipe Ø 600	Pipe Ø 630	Pipe Ø 700	Pipe Ø 710	Pipe Ø 800	Pipe Ø 1000	Pipe Ø 1200	Diam. inlet Easy Clip
		1C16058 Plus		1E16058 Plus	1H16058 Plus					1K16058 Plus			Ø 160
		1C16L58 Link		1E16L58 Link	1H16L58 Link					1K16L58 Plus			Ø 160
		1C20058 Link		1E20058 Link	1H20058 Link					1K20058 Link			Ø 200

Twin/structured wall plastic pipe ID

Installation tube annelé ID - Instalación tubo corrugado ID

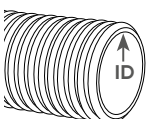

Pipe Ø 200	Pipe Ø 250	Pipe Ø 300	Pipe Ø 315	Pipe Ø 400	Pipe Ø 500	Pipe Ø 600	Pipe Ø 630	Pipe Ø 700	Pipe Ø 710	Pipe Ø 800	Pipe Ø 1000	Pipe Ø 1200	Diam. Innesto Easy Clip
	1432658 City												Ø 160
		1A16058 Plus		1E16058 Plus	1G16058 Plus	1H16058 Plus				1K16058 Plus			Ø 160
		1A16L58 Link		1E16L58 Link	1G16L58 Link	1H16L58 Link				1K16L58 Link			Ø 160
		1A20058 Link		1E20058 Link	1G20058 Link	1H20058 Link				1K20058 Link			Ø 200
		1Y16L58 Link		1Z16L58 Link									Ø 160 Shorter
		1Y20058 Link		1Z20058 Link									Ø 200 Shorter



on-line Easy Clip CONFIGURATOR <https://configuratore.redi.it/>

ISEA Water Management Systems



Rain and Waste Water Treatment
Water Reuse Solutions
Biological Filter Tanks, Interceptors
and Lifting Stations



Sustainable Solutions for Water Treatment

With the ISEA products range, Aliaxis provides a complete range of systems for rain and waste water management. The water treatment systems can be applied to civil, industrial and commercial building applications. An efficient water treatment and management system helps the prevention of soil and groundwater pollution.

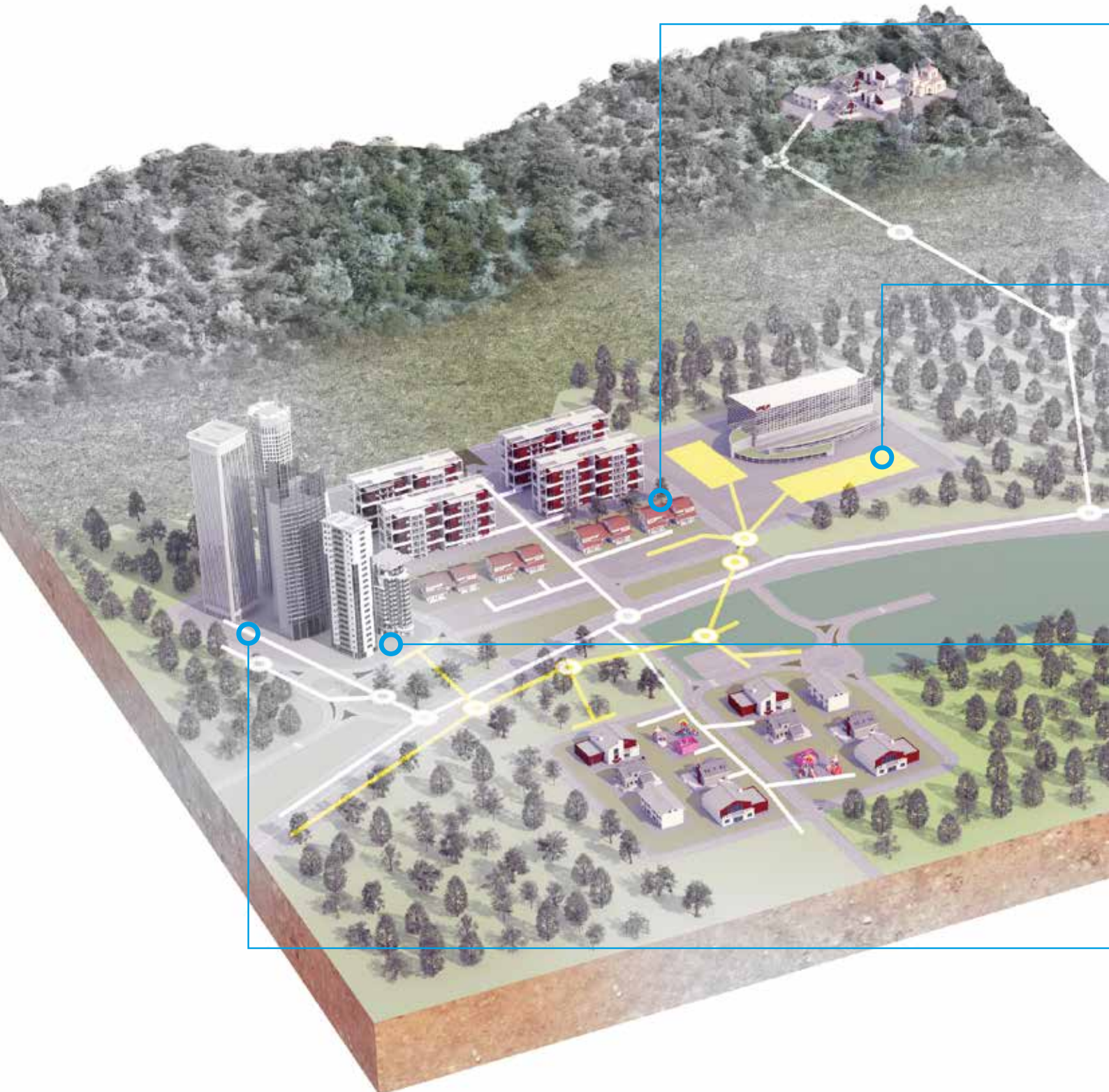



Wastewater from buildings: grey water and black water

Grease separators, septic tanks, Imhoff tanks and activated sludge or percolating filter treatment systems.



First flush systems

Management of rainwater run-off from paved surfaces such as car parks and yards.



Rainwater recycling

Collection and reuse of rainwater for irrigation and household uses (washing machines, toilet cisterns, car washing).



Water treatment and raising

Treatment of water containing oils from civil, industrial or commercial uses. Water raising stations to overcome differences in height and carry the water to higher areas.

Pre-Treatment Solutions



FAMILY, TOP, PUBLIC

Grease Interceptor

Nominal Size: from 0,2 to 14 l/s



PC

Elliptical Grease Interceptor

Nominal Size: 1 and 2 l/s



SL

Under Sink Grease Interceptor

Nominal Size: 0,11/s



SELF CLEAN

Automatic Grease Interceptor

Nominal Size: from 2 to 10 l/s



BIO HT

Biological Imhoff Tank

Users: from 3 to 85



BIO PC

Elliptical Imhoff Tank

Users: 3 and 4



HT PLUS

Oil Trap and Separator (Class I)

Nominal Size: from 3 to 30 l/s



HT

Oil Trap and Separator (Class II)

Nominal Size: from 0,5 to 30 l/s

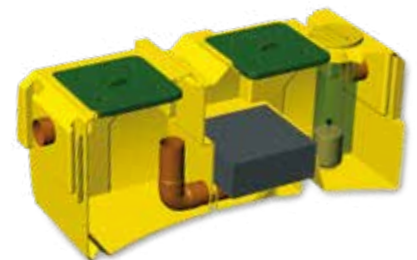

OTTO-PE

Oil Trap and Separator (Class I)

Nominal Size: from 1,5 to 6 l/s

Wastewater Treatment Units



ANAPACKAGE

Anaerobic percolating filter

Users from 5 to 100



PACKAGE

Aerobic percolating filter

Users from 5 to 100



SUPER PLUS

Activated sludge systems

Users from 5 to 25



SUPER PLUS MIX

Activated sludge systems

Users from 5 to 30



COMPACT

Activated sludge systems

Users from 32 to 60

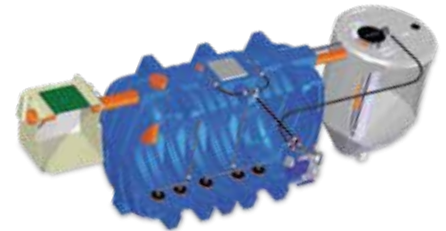

POLI 1

Activated sludge systems

Users from 50 to 200

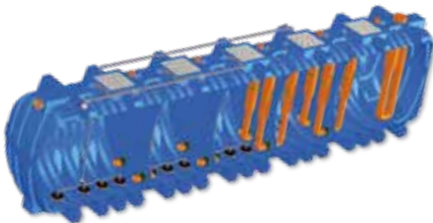

POLIMAXI

Activated sludge systems

Users from 130 to 300



COUNTRY

Reed bed system

Users from 2 to 20

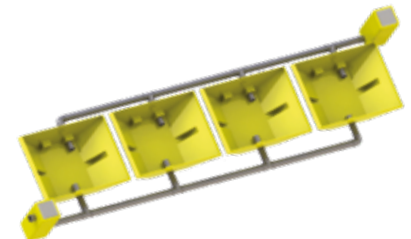

COUNTRY MAXI

Reed bed system

Users from 2 to 20

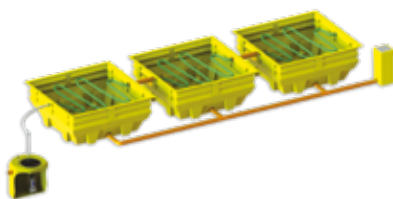

COUNTRY VERTICAL FLOW

Reed bed system

Users from 2 to 100



ECOWASH

Biofiltration system

Flow rate from 1,5 to 5 m³/h

Lifting Stations

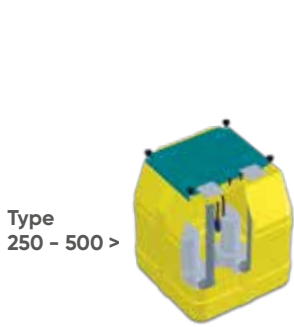

Type 250 - 500 >

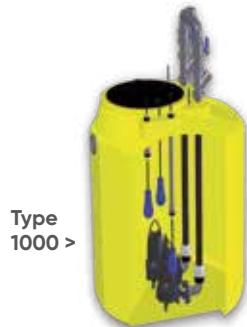

Type 1000 >



Pratica Family - Pratica - Pratica type rotomolding

Capacity from 250 to 1.000 liters

Pratica Public

Capacity from 3.000 to 5.000 liters

Water Recovery



ECO BOX

Refinement/Tertiary Wastewater System

Users: from 1 to 200



IRRIGA, RIUSA

Rainwater System

Capacity: from 3.500 to 41.000 liters



RECUPERA

Greywater System

Users: from 12 to 120

Storage for Liquids



TANK

Capacity from 550 to 12.500 liters



FLAT

Capacity from 5.000 liters



TANK-R

Capacity from 3.000 to 6.000 liters



MAXITANK

Capacity from 12.500 to 41.000 liters

REFERENCE LIST: reference - page

0011003	51	01307P8	25	0231142	232	03011P8	25	031920M	44	0414911	72
0041552	103	01309P8	25	023115E	232	0301402	43	0319242	234	04149P8	26
0076501	219	0131142	231	023115E	248	0301602	43	031925E	234	0415002	44
0076501	248	013115E	231	023120M	40	0301642	233	03192P8	25	0415011	72
0100411	71	01311P8	25	0231242	232	030165E	233	03409P8	26	04150P8	26
01004P8	24	013120M	41	023140M	40	03016P8	25	0341142	235	0415202	44
01005P8	24	0131242	231	0231542	229	0302002	43	034115E	235	0415402	45
01007P8	24	013125E	231	023160M	40	0302042	233	0341402	46	0415502	45
01009P8	24	01312P8	25	0231641	232	0302051	233	0342002	46	0421002	45
0101142	230	0131642	231	0231642	232	0302502	43	0342502	46	043050M	65
010115E	230	013165E	231	023200M	40	0302552	233	0342552	235	043100M	65
01011P8	24	01316P8	25	0232041	232	0302591	233	0342591	235	043300M	65
01011R2	103	0132042	231	0232042	232	0303002	43	0343002	46	0434351	283
0101242	230	013205E	231	0232242	229	0311602	44	0350142	236	0438042	283
010125E	230	0141402	42	0232502	40	0311642	234	035015E	236	0438091	283
01012P8	24	0142502	42	0233002	40	031165E	234	0350242	236	0438242	283
0101642	230	0142552	231	024030M	42	03116P8	25	035025E	236	0438291	283
010165E	230	0142591	231	024040M	42	0311741	235	03507P8	26	0438442	283
01016P8	24	0143002	42	024050M	42	0311742	235	035165E	236	0438491	283
0101742	229	0143052	231	024060M	42	0311832	235	03516P8	26	0438642	283
0102042	230	0143091	231	024070M	42	0311932	229	0351741	237	0438691	283
010205E	230	0144002	42	024080M	42	0312002	44	0352002	47	0438842	283
0102552	230	017100M	39	024100M	42	0312042	234	0352042	236	0438891	283
0102591	230	018100M	39	024110M	42	031205E	234	035205E	236	0439442	283
0103052	230	0201002	61	024115E	233	0312132	235	035270M	47	0439491	283
0103091	230	0201302	51	024120M	42	0312151	235	03527P8	26	044030M	43
0110411	71	0201303	51	0241242	232	0312232	229	03528P8	26	044040M	43
01104P8	24	0209202	54	0241302	42	031270M	44	035310M	47	044050M	43
01105P8	24	0210304	58	0241342	232	03127P8	25	03531P8	26	044060M	43
01107P8	24	0210304	216	024135E	232	03128P8	25	0353551	236	044070M	43
01109P8	24	0210404	58	024160M	42	031310M	44	0353642	236	044080M	43
0111142	230	0210404	216	0241641	232	03131P8	25	0353651	236	044100M	43
011115E	230	0210504	214	0241642	232	0313352	234	0353851	236	044110M	43
01111P8	24	0210804	214	024200M	42	0313391	234	0354042	236	0441141	234
0111242	230	0211104	214	0242141	232	0313442	229	0354051	236	0441142	234
011125E	230	0211341	231	0242142	232	0313502	44	035710M	47	0441241	234
01112P8	24	0211342	231	024230M	62	0313542	234	03571P8	26	0441242	234
0111642	230	0211641	231	024240M	62	031355E	234	0357251	236	044160M	43
011165E	230	0211642	231	0242502	42	0313602	44	03572P8	26	0441641	234
01116P8	24	0211742	229	0243002	42	0313642	234	0360502	47	0441642	234
0112042	230	0212204	214	02510A2	50	031365E	234	036070M	47	045030M	46
011205E	230	0212304	214	02514A2	50	0313702	44	0361002	47	045040M	46
0112552	230	0212404	214	02544A2	50	0313742	234	0361102	47	045050M	46
0112591	230	0212504	214	02555A2	50	031375E	234	0361141	237	045070M	46
0113052	230	0219004	207	02564A2	50	0313832	235	0361142	237	045080M	46
0113091	230	0219503	204	026030M	56	0313932	229	03611P8	26	045100M	46
01209P8	24	0219504	204	026040M	56	0314002	44	0361202	47	045110M	46
0121142	230	0221341	232	027030M	41	0314052	234	0361242	237	0451242	236
012115E	230	0221342	232	027040M	41	0314091	234	0361602	47	0451342	233
01211P8	24	0221641	232	027050M	41	0314152	234	0361642	237	045135E	233
0121402	41	0221642	232	027100M	41	0314191	234	038070M	47	045160M	46
0122502	41	023030M	40	028030M	40	0314252	234	0381002	47	0451641	236
0122552	230	023040M	40	028040M	40	0314291	234	0381102	47	0451642	236
0122591	230	023050M	40	028050M	40	0314352	234	0381142	238	0460141	237
0123002	41	023060M	40	028100M	40	0314391	234	03811P8	26	0460242	237
0123052	230	023070M	40	02910P8	27	031510M	44	0411102	48	0460641	237
0123091	230	023080M	40	02912P8	27	0315111	72	0413302	48	0460642	237
0124002	41	023100M	40	0301142	233	03151P8	25	0413402	48	0463642	237
0125002	41	023110M	40	030115E	233	031720M	44	0414702	48	0480903	91

0480903	102	0533152	103	061205E	243	0634052	242	0663001	239	07210P8	25
0481003	52	05331P8	27	0612502	49	0634091	242	0663002	64	073030M	41
0481003	91	0534142	241	0612552	243	063445M	66	0663002	239	073040M	41
0481003	102	0534151	241	0612591	243	06344P8	28	06634F1	239	073050M	41
0481103	52	0534202	53	0613002	49	063455M	66	06634F2	64	073070M	41
0481103	91	0534242	241	0613052	243	06345P8	28	06634F2	239	0730711	71
0481103	102	0534251	241	0613091	243	0635589	74	06640F1	239	07307P8	24
0503102	54	0534802	53	0614052	243	063558M	103	06640F2	64	073080M	41
0503311	73	0534842	241	0614091	243	0635689	74	06640F2	239	073100M	41
0503312	103	0534851	241	061445M	66	063568M	103	06640M1	239	073110M	41
05033P8	27	054040M	54	06144P8	28	0641642	242	06640M2	64	073120M	41
051070M	53	054050M	54	06145P8	28	065060M	64	06640M2	239	074030M	42
0510711	73	054060M	55	0621091	241	065070M	64	0669902	64	074040M	42
05107P8	27	054070M	55	0621191	241	06507P8	30	06699P8	30	074050M	42
051110M	53	054080M	55	0621192	241	065080M	64	0686348	27	074070M	42
0511111	73	054090M	55	0621291	241	0650902	64	0686348	240	0740711	71
05111P8	27	054100M	55	0621292	241	06509P8	30	0686348	281	07407P8	25
0511602	53	054120M	55	0621691	241	065100M	64	0700411	71	074080M	42
0511642	240	054130M	55	0621692	241	0651101	238	07004P8	24	074100M	42
051165E	240	054150M	55	0621791	241	0651102	64	0700511	71	074110M	42
05116P8	27	054160M	55	0622091	241	0651102	238	07005P8	24	074115E	233
0512002	53	054200M	55	062320M	49	0651201	238	070060M	41	074120M	42
0512042	240	054250M	54	062400M	49	0651202	64	0700611	71	074160M	42
051205E	240	054300M	55	063030M	49	0651202	238	0701011	71	074200M	42
0512502	53	054400M	55	063040M	49	065320M	64	07010P8	24	074230M	62
0512542	240	054600M	55	063050M	49	065400M	64	0701242	230	074240M	62
051255E	240	054700M	55	063060M	49	065500M	64	070125E	230	07424P8	28
0513002	53	054800M	55	063070M	49	0660402	64	07012P8	24	074530M	62
0513052	240	054850M	55	06307P8	28	06604P8	30	0701542	229	074540M	62
0513091	240	054910M	55	063080M	49	0660502	64	0701602	41	07454P8	29
0513102	53	054920M	55	06309P8	28	06605P8	30	0701642	230	078030M	40
05131P8	27	054930M	55	063100M	49	0661002	61	070165E	230	078040M	40
051320M	53	054940M	55	06310P8	28	0661102	64	07016P8	24	078050M	40
0513242	240	054950M	55	063110M	49	0661102	239	0702002	41	078100M	40
0513252	103	054960M	55	0631142	242	066110E	239	0702042	230	0781011	71
051325E	240	054970M	55	063115E	242	06611P8	30	070205E	230	07810P8	24
05132P8	27	054980M	55	0631181	242	0661202	64	0702242	229	0800411	72
0513302	53	054990M	55	0631182	242	0661202	239	0708211	71	08004P8	25
0513342	240	06010C3	51	06311P8	28	066120E	239	0710411	71	0800511	72
051335E	240	06010L3	52	063120M	49	06612P8	30	07104P8	25	08005P8	25
0513602	53	0601103	52	0631242	242	06613F1	239	0710511	71	080120M	43
0513642	240	06031C3	51	063125E	242	06613F2	64	07105P8	25	0801242	233
051365E	240	06031L3	52	0631281	242	06613F2	239	071060M	42	080125E	233
05136P8	27	060320M	56	06312P8	28	06615F1	239	0710611	71	08012P8	25
0514002	53	061030M	49	0631602	49	06615F2	64	07109P8	25	08104P8	26
0514042	240	061040M	49	0631642	242	06615F2	239	0711011	71	08105P8	26
051405E	240	061050M	49	063165E	242	0661602	64	07110P8	25	0810602	46
0514602	53	0610751	73	0631681	242	0661602	239	0711102	42	0811011	72
0514642	240	06107P8	28	06316P8	28	066160E	239	0711142	231	08110P8	26
0514651	240	06109P8	28	0632002	49	06616P8	30	071115E	231	081120M	46
0515602	53	061100M	49	0632042	242	06617F1	239	07111P8	25	0811242	235
0519202	53	06110P8	28	063205E	242	06617F2	64	07111R2	103	081125E	235
0519252	240	0611142	243	0632081	242	06617F2	239	0711242	231	08112P8	26
0519291	240	061115E	243	063228M	66	0662002	64	071125E	231	0811602	46
0520952	104	06111P8	28	063238M	66	0662002	239	07112P8	25	0811642	235
0521152	104	061120M	49	0632502	49	066200E	239	0711642	231	081165E	235
0530702	54	0611242	243	0632552	242	06621F1	239	071165E	231	08116P8	26
0530711	74	061125E	243	0632581	242	06621F2	64	07116P8	25	0812042	235
053075M	103	06112P8	28	0632591	242	06621F2	239	0712042	231	081205E	235
0531012	103	0611602	49	0633002	49	0662501	239	071205E	231	0818211	72
05310P8	27	0611642	243	0633052	242	0662502	64	072030M	41	083100M	44
0531152	103	061165E	243	0633081	242	0662502	239	072040M	41	0831011	72
05311P8	27	06116P8	28	0633091	242	06628F1	239	072050M	41	08310P8	25
0533102	54	0612002	49	063338M	66	06628F2	64	072100M	41	083300M	44
0533111	74	0612042	243	063348M	66	06628F2	239	0721011	71	0833011	72

08330P8	25	0951042	58	12R1148	260	1443542	235	1553001	263	1691007	116
083500M	44	0961002	57	12R1248	260	1444041	235	1553091	263	1691009	116
0841002	47	0961602	59	12R1648	260	1444042	235	1554091	263	1691103	116
0843002	47	096435X	247	12S1008	261	1444142	235	1555001	262	1691203	116
08430P8	26	096495X	247	12S1108	261	1444241	235	1555052	262	1698203	116
0845002	47	0971022	57	12S1208	261	1444242	235	1555101	262	1750052	243
088030M	43	0971042	57	12S1608	261	1444342	235	1555501	262	1750091	243
088040M	43	0981042	58	1303052	233	1444442	235	1555551	262	1751352	243
088050M	43	0995508	282	1303091	233	1444551	235	1555601	262	1751391	243
088060M	43	0996008	282	1314451	234	1446642	235	1555651	262	1751409	65
0880611	72	0996606	282	1315351	234	1447741	235	1556001	262	1751609	65
088070M	43	OTAMUPP	102	1315451	234	1447742	235	1556051	262	1751652	244
0880711	72	1102141	231	1316651	234	1452002	46	1556151	262	1751691	244
08807P8	25	1102142	231	1317751	234	1452041	236	1562201	265	1752009	65
088080M	43	1102241	231	1318051	234	1452042	236	1563301	265	1752052	244
08809P8	25	1102242	231	1318151	234	1452502	46	1564401	265	1752091	244
088100M	43	1103341	231	1343052	235	1452541	236	1565501	265	17710A2	52
0881011	72	1103342	231	1343091	235	1452542	236	1566601	265	1771402	52
08810P8	25	1104052	230	1344051	235	1453002	46	157161X	265	17714A2	52
088110M	43	1104091	230	1344052	235	1453041	236	1572206	265	17714C2	52
089030M	46	1104452	231	1352251	236	1453042	236	157221X	265	1790509	65
089040M	46	1112141	232	1354151	236	1454051	236	1573306	265	1790609	65
089050M	46	1112142	232	1354451	236	1454052	236	1574406	265	1790809	65
089070M	46	1112242	232	1355051	236	1461242	237	1576606	265	1790902	103
08907P8	26	1113342	232	1355551	236	1461642	237	1577708	265	1791009	65
089080M	46	1114052	230	1356651	236	1461651	237	1582208	265	1791102	103
089100M	46	1114091	230	1357751	236	1462042	237	1583308	265	1791209	65
089110M	46	1114452	232	1358851	236	1462051	237	1585501	265	1792202	103
089135E	233	1124052	230	1359951	236	1464141	237	16009B3	95	1795502	103
08913P8	26	1124091	230	1359952	236	1464142	237	16009LB	95	1797702	103
0900511	73	1125052	230	1402552	238	1464242	237	16010C3	51	1798802	103
09005P8	27	1125091	230	1402591	238	1464342	237	16010L3	52	18207P8	27
0900602	53	1144052	231	1403002	45	1464442	237	1601103	52	182100M	45
0900611	73	1144091	231	1403091	238	1464451	237	16031C3	51	1821011	73
090080M	53	1145052	231	1404351	238	1467741	237	16031L3	52	18210P8	27
090100M	53	1145091	231	1404352	238	1468842	237	1615051	243	182110M	45
0901011	73	11912D1	244	1424251	283	1469942	237	1615052	243	1821142	238
09010P8	27	11912S1	244	142525E	283	1471691	240	1635051	242	182115E	238
090120M	53	11916D1	244	142625E	283	1472091	240	1635052	242	18211P8	27
0901211	73	11916S1	244	1431158	274	1475551	240	1651601	238	1821242	238
09012P8	27	11R1048	260	1431658	275	1476051	240	1651602	64	182125E	238
090260M	53	11R1148	260	1432258	274	1533542	241	1651602	238	18212P8	27
0902611	73	11R1248	260	1432658	275	1533551	241	1652001	238	1821602	45
0902802	53	11R1648	260	1433242	283	1534051	241	1652002	64	1821642	238
0903002	53	11S1008	261	1433358	274	1534342	241	1652002	238	182165E	238
0903011	73	11S1108	261	1434458	274	1534351	241	1652501	239	18216P8	27
090480M	53	11S1208	261	1439091	283	1535042	241	1652502	64	1822042	238
0904811	73	11S1608	261	1439191	283	1535542	241	1652502	239	182205E	238
09048P8	27	1232541	232	1439242	283	1535551	241	16525F2	239	1853351	244
090500M	53	1232542	232	1439291	283	1536042	241	1653001	239	1854451	244
0907311	73	1233041	232	1439591	283	1536051	241	1653002	64	1855551	244
091050M	53	1233042	232	1439691	283	1536542	241	1653002	239	1856651	244
091250M	53	1234051	232	1442002	43	1536551	241	16530F2	239	1857751	244
092050M	54	1234052	232	1442041	234	1537052	241	16530T1	265	1858851	244
092250M	54	1242541	232	1442042	234	1537091	241	1690007	133	1943042	245
0930302	61	1242542	232	1442502	43	1551401	262	169000W	133	1943242	245
0930402	61	1243041	232	1442542	234	1551501	262	1690502	116	1943842	245
0930502	61	1243042	232	1442551	234	1551601	262	1690503	116	1944042	245
09305P8	28	1244051	232	1443002	43	1551691	262	1690602	116	1944642	245
0930712	104	1244052	232	1443041	234	1551701	262	1690603	116	1944842	245
0930812	104	1290302	39	1443042	234	1551791	262	1690702	116	1951242	246
0931211	74	1290402	39	1443141	235	1552001	262	1690803	116	1951642	246
0931212	104	1290502	39	1443142	235	1552091	262	1690807	116	1952042	246
0941042	57	1291002	39	1443442	235	1552501	263	1691002	116	1953042	245
0951022	58	12R1048	260	1443451	235	1552591	263	1691003	116	1953242	245

1953842	245	6721100	107	B821200	57	E13TU0R	126	E223004	214	E722004	180
1954042	245	6741500	107	B821400	57	E13TUG5	126	E2233CR	216	E72200V	182
1954642	245	6742500	107	BH244NI	43	E13TUGR	126	E223504	214	E723004	180
1954842	245	6745000	107	C130403	68	E1613A4	203	E224004	217	E72300V	182
1960402	60	6746000	107	C13PEAI	68	E1613B4	202	E2240AI	217	E724004	180
1961002	60	6800600	106	C170300	105	E162504	200	E224204	217	E72400V	182
1961202	59	6800900	106	C170400	105	E16TU05	126	E2242AI	217	E724504	180
19613B2	59	6801000	74	C180500	105	E16TU0R	126	E224504	217	E72450V	182
1962942	245	6808200	74	C221004	214	E16TUG5	126	E2245AI	217	E725504	180
196435X	246	6820300	63	C661200	56	E1710B4	200	E225004	217	E72550V	182
196495X	246	6820400	63	C661400	56	E1710B4	200	E2250AI	217	E731404	202
1991658	249	6820400	90	CD08500	23	E1711A4	203	E22QS05	128	E731704	203
1992204	219	6820401	63	CD08500	107	E1712PP	194	E23TU05	127	E7810AI	213
1992404	219	6820401	90	CD11100	23	E1713A4	203	E23TUG5	127	E7810PP	213
1992504	219	6820500	29	CD11100	107	E1713B4	202	E23TUGR	127	E7815AI	213
1993302	60	6820500	63	CD11500	23	E1714PP	194	E24140M	42	E7910AI	213
19935F2	59	6820500	90	CD11500	107	E1718PP	195	E250504	207	E7910PP	213
19937F2	59	6820501	29	COLLA00	68	E1719B4	206	E2510B4	201	E7915AI	213
1999903	67	6820501	63	COLLA00	107	E1720A4	206	E255704	181	E7915PP	213
19999S3	67	6820501	90	COLLA00	261	E1721B4	206	E255804	182	E802504	175
199CLPP	99	6820502	29	COLLA12	68	E1722A4	206	E25580V	182	E80250V	175
199PE03	67	6820502	63	COLLA12	107	E172705	129	E255904	181	E97BG00	221
1A16058	277	6820502	90	COLLA12	261	E17270R	129	E256004	181	E97BG10	221
1A16L58	279	6823200	63	COLLA25	68	E17QU05	128	E25600V	182	E97IM00	221
1A20058	279	6824404	63	COLLA25	107	E17QUG5	128	E256304	182	E98PRAO	221
1C16058	277	68255LU	63	COLLA25	261	E1810B4	200	E25630V	182	E98PRBO	221
1C16L58	279	68260LU	63	COLLA50	68	E1811B4	200	E256404	181	E9910AI	220
1C20058	279	68265LU	63	COLLA50	107	E1813A4	202	E256504	181	E9910PP	220
1CO1100	265	6830400	74	COLLA50	261	E1813B4	201	E256604	181	E9914AI	220
1CO1600	265	6830400	106	COU3252	101	E1820A4	205	E256704	180	E9915AI	220
1D16058	277	6830500	74	COU4052	101	E1821B4	206	E256904	180	E9915PP	220
1D16L58	279	6830500	106	COU5052	101	E18QS05	128	E257004	180	E99PRAO	221
1D20058	279	6830700	74	D312611	72	E18TU05	127	E25700V	182	E99PRBO	221
1E16058	277	6830700	106	D312711	72	E18TU0R	127	E257404	180	EAL22AI	218
1E16L58	279	6831000	106	D312811	72	E18TUG5	127	E257504	180	EAL33PP	218
1E20058	279	6831100	106	D313491	234	E191004	214	E257604	180	EAL44AI	218
1G16058	277	6831200	106	D314452	234	E191504	214	E257704	205	EAS14AI	212
1G16L58	279	6831600	106	D314491	234	E192004	214	E257804	182	EAS14PP	212
1G20058	279	6834300	247	D314691	234	E192504	214	E25780V	182	EAS15AI	212
1H16058	277	7302800	220	D314791	234	E192604	214	E26TU05	127	EAS15PP	212
1H16L58	279	7302800	248	D314991	234	E193004	214	E273304	176	EAS24AI	212
1H20058	279	7803000	106	D315091	234	E195004	215	E274404	176	EAS24PP	212
1J16058	277	7810003	51	D315191	234	E195504	215	E275504	176	EAS25AI	212
1J16058	279	A070506	108	D354652	236	E196004	215	E276604	176	EAS25PP	212
1J20058	279	A080506	30	D354691	236	E196104	215	E292204	179	EAS35AI	212
1K16058	277	A080506	107	D354991	236	E196204	215	E293304	179	EAS45AI	212
1K16L58	279	ACIKSDZ	282	D355091	236	E196304	215	E294404	179	EBA11PP	217
1K20058	279	AC2CSDZ	282	D355191	236	E196404	215	E44120M	43	EBA22AI	217
1KIT15E	248	AD1513P	282	D501212	103	E202004	178	E44140M	43	EBA33PP	217
1KLMA00	265	AD2013P	282	D519491	240	E20200V	178	E45120M	46	EBA44AI	217
1PA1608	123	AV00500	30	D610611	73	E203004	178	E511002	53	EBU1008	198
1SP1100	265	AV00500	105	D616391	243	E20300V	178	E511302	53	EBU1108	198
1SP1600	265	AV00700	30	D665001	239	E203504	178	E511502	53	ECAIXPP	194
1T11658	280	AV00700	105	D931111	74	E20350V	178	E512202	53	ECAZNPP	194
1T21658	280	AV00900	30	D931112	104	E204004	178	E682004	181	ECBIXPP	195
1X16058	277	AV00900	105	E06T105	125	E20400V	178	E68200V	182	ECBZNPP	195
1X16L58	279	AV01000	30	E06TIG5	125	E204504	178	E683004	181	ECCIXPP	194
1X20058	279	AV01000	105	E08T105	125	E20450V	178	E68300V	182	ECCPPOV	194
1Y16058	277	AV01100	30	E08TIG5	125	E205604	178	E684004	181	ECCZNPP	194
1Y16L58	279	AV01100	105	E10T105	125	E20560V	178	E68400V	182	ECDIXPP	195
1Y20058	279	AV01200	30	E10T10R	125	E21QU05	128	E684504	181	ECDPP0V	195
1Z16058	277	AV01200	105	E10TIG5	125	E21QUG5	128	E68450V	182	ECDZNPP	195
1Z16L58	279	AV01600	30	E12T105	125	E220504	214	E685504	181	ECM3504	178
1Z20058	279	AV01600	105	E12TIG5	125	E2222CR	216	E68550V	182	ECM4504	178
6721100	68	B661202	56	E13TU05	126	E222504	214	E721004	201	ECM5004	178

ECN3004 183	GTI55AL 131	M060535 147	MD1630P 151	MG1320A 158	MM4320P 149
ECN4004 183	GTI65AL 131	M061515 147	MD2121P 151	MG1400A 158	MM4400P 149
ECR3004 183	GTM13RA 130	M061516 147	MD2122P 151	MG1500A 158	MM4510P 149
ECR4004 183	GTM17RA 130	M6103FG 104	MD2124P 151	MG1630A 158	MM4630P 149
EDP1104 218	GTM23RA 130	M6104FG 104	MD2140P 151	MG1750A 158	MM4730P 149
EFS10AI 213	GTM30AL 131	M6704FG 105	MD2180P 151	MG1751A 158	MM5135P 155
EFS15AI 213	GTM35AL 131	M6733FG 105	MD2200P 151	MK2100A 158	MM5136P 155
EG2B125 198	GTM40AL 131	MA1160P 156	MD2220P 151	MK2260A 158	MM5138P 155
EGF10PP 193	H991604 219	MA1170P 156	MD2250P 151	MK2PE0A 158	MMC132A 157
EGF15PP 193	H999941 248	MA1210P 156	MD2280P 151	MK3260A 157	MMC160A 156
EGF20PP 193	J022087 60	MA3162C 156	MD2300P 151	MK3PBOA 157	MMC200A 156
EGFBOPP 193	J022087 220	MA3163C 156	MD2310P 151	MLH00NI 39	MMC260A 156
EGFB5PP 193	KO088PE 106	MA3164C 156	MD2340P 151	MM1160P 149	MPH00NI 39
EGFBAPP 193	KO089PE 106	MA3172C 156	MD2360P 151	MM1200P 149	MPR010P 155
EGQ5005 130	KO090PE 106	MA3173C 156	MD2380P 151	MM1210P 149	MRH00NI 39
EGQ9005 130	K0091PE 106	MA3174C 156	MD3150P 151	MM1260P 149	MS1600C 157
EGR3004 183	K0092PE 106	MB1160P 155	MD3230P 151	MM1270P 149	MS1610C 157
EGR4004 183	K0095PE 106	MB1200P 155	MD3270P 151	MM1320P 149	MSB200A 157
EGRAA15 198	K0096PE 106	MB1260P 155	MD3320P 151	MM1400P 149	MSB400A 157
EGRB125 198	K0097PE 106	MB1320P 155	MD3350P 151	MM1510P 149	MT1100C 156
EGRC250 198	K2530PE 95	MB1400P 155	MD3370P 151	MM1630P 149	MT116PT 145
EGRZA15 198	K2531PE 95	MB1500P 155	MD3400P 151	MM1631P 151	MT120PT 145
EKVGFO0 124	KITC500 221	MB1630P 155	MD3410P 151	MM1650P 153	MT126PT 145
EP75104 215	LSCAT00 99	MB1750P 155	MD3420P 151	MM1730P 149	MT132PT 145
EP75804 215	LSSIF00 99	MC1160P 153	MD3430P 151	MM2160P 150	MT1340C 156
EP75904 215	M010520 146	MC1161P 149	MD3440P 151	MM2200P 150	MT2100C 156
EP76004 215	M010566 145	MC1162P 149	MD3450P 151	MM2260P 150	MT2120C 156
EP76404 215	M011510 146	MC1200P 153	MD3460P 151	MM2320P 150	MT2340C 156
EP76904 215	M011535 145	MC1260P 153	MD3470P 151	MM2400P 150	MTH00NI 39
EP77404 215	M012610 146	MC1320P 153	MD3480P 151	MM2500P 150	MV1160P 155
EP95604 215	M012626 145	MC1400P 153	MD4160P 152	MM2630P 150	MV1200P 155
EPA0603 123	M013208 145	MC1500P 153	MD4161P 152	MM2750P 150	MVH00NI 39
EPAGF03 124	M013220 146	MC1630P 153	MD4200P 152	MM3210P 150	MXH00NI 39
ETTQ304 177	M020511 145	MC2160P 153	MD4210P 152	MM3240P 150	MZH00NI 39
ETTQ304 247	M021514 145	MC2200P 153	MD4260P 152	MM3260P 150	N105091 230
ETTQ30V 177	M022612 145	MC2201P 153	MD4320P 152	MM3310P 150	N106391 230
EZ10ACI 199	M023208 145	MC2203P 153	MD4400P 152	MM3320P 150	N115091 230
EZ10ALA 199	M023307 145	MC2210P 153	MD4500P 152	MM3390P 150	N116391 230
EZ10CAI 199	M023407 145	MC2260P 153	MD4630P 152	MM3400P 150	N126391 230
EZ10GCI 199	M023507 145	MC2320P 153	MD5142P 152	MM3480P 150	N146391 231
EZ10GLA 199	M023602 145	MC2400P 153	MD5143P 152	MM3481P 151	N1C85E1 244
G400800 219	M040505 146	MC2510P 153	MD5144P 152	MM3482P 151	N1C86E1 244
G401000 219	M040511 146	MC2630P 153	MD5145P 152	MM3490P 150	N1C87E1 244
G401200 219	M040514 147	MC3131P 152	MD5160P 152	MM3500P 150	N1C88E1 244
G456000 219	M040516 146	MC3133P 152	MD5200P 152	MM3620P 150	N304091 233
GRS14RA 130	M040537 145	MC3160P 152	MD5210P 152	MM3630P 150	N305091 233
GRS23RA 130	M041504 146	MC3200P 152	MD5260P 152	MM3640P 150	N306391 233
GRS25RA 130	M041505 146	MC3210P 152	MD5320P 152	MM3641P 150	N345091 235
GRS35RA 130	M041513 146	MC3260P 152	MD5400P 152	MM3642P 150	NC879E1 264
GRS40AL 131	M041524 145	MC3320P 152	MD5500P 152	MM4131P 154	NC887E1 264
GRS45AL 131	M041528 145	MC3400P 152	MD5630P 152	MM4132P 154	NC919E1 264
GRS50AL 131	M041534 147	MC3510P 152	MD5640P 152	MM4133P 154	NW29104 190
GRS55AL 131	M042600 147	MC3630P 152	MF3138P 154	MM4134P 154	NW73304 190
GTI08RA 130	M042603 146	MCA010P 155	MF3160P 154	MM4135P 154	P551002 266
GTI10RA 130	M042604 146	MCT200A 156	MF3182P 154	MM4136P 154	P5510F1 266
GTI12RA 130	M042605 146	MCT260A 157	MF3184P 154	MM4137P 154	P5510G1 267
GTI14RA 130	M042617 145	MCT400A 156	MF3200P 154	MM4138P 154	P5510M1 266
GTI15RA 130	M043206 146	MD1160P 151	MF5160P 154	MM4139P 154	P551202 266
GTI16RA 130	M043207 146	MD1200P 151	MG1140P 153	MM4140P 154	P5512F1 266
GTI20RA 130	M043208 145	MD1260P 151	MG1160A 158	MM4141P 154	P5512G1 267
GTI30AL 131	M043209 146	MD1261P 151	MG1160P 153	MM4160P 149	P5512M1 266
GTI35AL 131	M043221 147	MD1262P 151	MG1200A 158	MM4200P 149	P551602 266
GTI40AL 131	M060508 147	MD1320P 151	MG1200P 153	MM4210P 149	P5516F1 266
GTI45AL 131	M060509 147	MD1400P 151	MG1210P 153	MM4260P 149	P5516G1 267
GTI50AL 131	M060534 147	MD1500P 151	MG1260A 158	MM4270P 149	P5516M1 266

P552002	266	V0109P8	22	W550302	98	Y881004	187	Z2523PP	95	Z3950PP	84
P5520F1	266	V0110P8	22	W550402	98	Y881104	187	Z2525PP	95	Z3975PP	84
P5520G1	267	V0111P8	22	W550502	98	Y891004	187	Z2540PP	93	Z3990PP	84
P5520M1	266	V0112P8	22	W550602	98	Z0250PP	99	Z2544PP	93	Z4011PP	84
P552501	266	V0116P8	22	W600302	98	Z0260PP	99	Z2550PP	93	Z4016PP	84
P5525F1	266	V0175P8	22	W600402	98	Z1011PP	81	Z2555PP	93	Z4090PP	84
P5525G1	267	V0204P8	22	W600502	98	Z1012PP	81	Z2566PP	93	Z4111PP	84
P5525M1	266	V0205P8	22	W672004	205	Z1016PP	81	Z2650PP	89	Z4190PP	84
P553001	266	V0209P8	22	W6816PP	197	Z1032PP	81	Z2711PP	95	Z4211PP	85
P5530F1	266	V0210P8	22	W6817PP	196	Z1040PP	81	Z2910PP	89	Z4250PP	85
P5530G1	267	V0211P8	22	W6820FX	198	Z1050PP	81	Z2911PP	90	Z4275PP	85
P5530M1	266	V0212P8	22	W721503	204	Z1075PP	81	Z2912PP	90	Z4311PP	85
P554001	266	V0216P8	22	W721504	204	Z1090PP	81	Z2913PP	90	Z4511PP	85
P5540F1	266	V0275P8	22	W949400	184	Z1111PP	81	Z2915PP	89	Z4540PP	85
P5540G1	267	V0304P8	22	WAM110M	116	Z1112PP	81	Z2916PP	89	Z4550PP	85
P5540M1	266	V0305P8	22	WAM430M	116	Z1116PP	81	Z2917PP	89	Z4611PP	85
P555001	266	V0309P8	22	WAM650M	116	Z1132PP	81	Z2918PP	89	Z4650PP	85
P5550F1	266	V0310P8	22	WAM870M	116	Z1140PP	81	Z2920PP	90	Z4675PP	85
P5550M1	266	V0311P8	22	WCA13PP	197	Z1150PP	81	Z3011PP	82	Z4711PP	85
P556301	266	V0312P8	22	WCB13PP	196	Z1175PP	81	Z3012PP	82	Z4712PP	85
P5563F1	266	V0316P8	22	WCD13PP	196	Z1190PP	81	Z3016PP	82	Z4803CR	100
P5563M1	266	V0375P8	22	WGPAFOO	198	Z1211PP	81	Z3032PP	82	Z4811PP	85
PHONK10	30	V0504P8	22	X121503	95	Z1212PP	81	Z3040PP	82	Z4950PP	85
PHONK10	30	V0505P8	22	X121504	95	Z1216PP	81	Z3044PP	86	Z5011PP	89
PHONK10	105	V0509P8	22	X4440NI	55	Z1232PP	81	Z3050PP	82	Z5012PP	89
PHONK11	30	V0510P8	22	Y112004	176	Z1240PP	81	Z3075PP	82	Z5016PP	89
PHONK11	30	V0511P8	22	Y113004	176	Z1250PP	81	Z3090PP	82	Z5040PP	89
PHONK11	105	V0512P8	22	Y114004	176	Z1275PP	81	Z3111PP	83	Z5050PP	89
PHONK12	30	V0516P8	22	Y115504	176	Z1290PP	81	Z3132PP	83	Z5075PP	89
PHONK12	30	V0575P8	22	Y212104	174	Z1311PP	82	Z3140PP	83	Z5090PP	89
PHONK12	105	V16T105	126	Y213104	174	Z1332PP	82	Z3150PP	83	Z5110PP	89
PHONK16	30	V20T105	126	Y222004	174	Z1340PP	82	Z3175PP	83	Z5111PP	89
PHONK16	30	V371205	129	Y22200V	174	Z1350PP	82	Z3211PP	83	Z5116PP	89
PHONK16	105	V372205	129	Y223004	174	Z1375PP	82	Z3212PP	83	Z5150PP	89
PHONK50	30	VAE3205	127	Y22300V	174	Z1390PP	82	Z3216PP	83	Z5175PP	89
PHONK50	30	VF104P8	23	Y224004	174	Z1411PP	82	Z3232PP	83	Z5190PP	88
PHONK50	105	VF105P8	23	Y22400V	174	Z1412PP	82	Z3240PP	83	Z5290PP	89
PHONK75	30	VF109P8	23	Y225504	174	Z1416PP	82	Z3250PP	83	Z5331PP	103
PHONK75	30	VF110P8	23	Y22550V	174	Z1432PP	82	Z3275PP	83	Z5440PP	88
PHONK75	105	VF111P8	23	Y312104	174	Z1440PP	82	Z3290PP	83	Z5450PP	88
PHONK90	30	VF112P8	23	Y313104	174	Z1450PP	82	Z3310PP	83	Z5540PP	88
PHONK90	30	VF175P8	23	Y332004	174	Z1475PP	82	Z3311PP	83	Z5550PP	88
PHONK90	105	VF204P8	23	Y33200V	174	Z1490PP	82	Z3312PP	83	Z5575PP	88
PIAOXNI	61	VF205P8	23	Y332204	177	Z2090PP	94	Z3316PP	83	Z5630PP	88
POZ160V	184	VF209P8	23	Y333004	174	Z2104PP	94	Z3340PP	83	Z5634PP	88
POZ240V	184	VF210P8	23	Y33300V	174	Z2105PP	94	Z3350PP	83	Z5640PP	88
POZ260V	184	VF211P8	23	Y333204	177	Z2140PP	94	Z3375PP	83	Z5641PP	88
POZ4208	247	VF212P8	23	Y334004	174	Z2144PP	94	Z3390PP	83	Z5650PP	88
POZ500V	184	VF275P8	23	Y33400V	174	Z2150PP	94	Z3411PP	83	Z5675PP	88
QA150RH	108	VF304P8	23	Y334204	177	Z2155PP	94	Z3416PP	83	Z5690PP	88
QA160RH	108	VF305P8	23	Y335204	177	Z2190PP	94	Z3475PP	83	Z5775PP	88
R6000NI	55	VF309P8	23	Y335504	174	Z2290PP	92	Z3490PP	83	Z5803PP	100
T555191	264	VF310P8	23	Y33550V	174	Z2304PP	101	Z3511PP	83	Z5804PP	100
T556391	264	VF311P8	23	Y661304	188	Z2314PP	102	Z3590PP	83	Z6111PP	87
T651000	61	VF312P8	23	Y661504	189	Z2340PP	101	Z3611PP	84	Z6112PP	87
T651000	96	VF375P8	23	Y661904	189	Z2344PP	102	Z3640PP	84	Z6116PP	87
T651000	102	VF504P8	23	Y662004	189	Z2350PP	101	Z3650PP	84	Z6132PP	87
TAD1000	108	VF505P8	23	Y662204	188	Z2355PP	102	Z3675PP	84	Z6140PP	87
TT00100	30	VF509P8	23	Y663304	188	Z2405PP	92	Z3711PP	84	Z6150PP	87
TT00100	108	VF510P8	23	Y665504	190	Z2444PP	92	Z3811PP	84	Z6175PP	87
TT00200	30	VF511P8	23	Y6666PQ	190	Z2450PP	92	Z3910PP	84	Z6190PP	87
TT00200	108	VF512P8	23	Y6677PO	190	Z2455PP	92	Z3911PP	84	Z6311PP	87
U391002	47	VF575P8	23	Y6688PO	190	Z2504PP	93	Z3912PP	84	Z6312PP	87
V0104P8	22	VGR4305	129	Y771504	189	Z2505PP	93	Z3916PP	84	Z6316PP	87
V0105P8	22	VGR6305	129	Y772004	189	Z2511PP	92	Z3940PP	84	Z6332PP	87

Z6340PP	87	ZMG32PP	90	ZT711PP	79
Z6350PP	87	ZMG51PP	90	ZT712PP	79
Z6375PP	87	ZP112PP	104	ZT716PP	79
Z6390PP	87	ZP114PP	104	ZT721PP	80
Z6490PP	87	ZP212PP	104	ZT722PP	80
Z6511PP	87	ZP214PP	104	ZT726PP	80
Z6512PP	87	ZT111PP	79	ZT732PP	79
Z6540PP	87	ZT140PP	79	ZT733PP	80
Z6550PP	87	ZT150PP	79	ZT740PP	79
Z6575PP	87	ZT175PP	79	ZT743PP	80
Z6810PP	90	ZT190PP	79	ZT750PP	79
Z6811PP	90	ZT211PP	79	ZT753PP	80
Z6861PP	101	ZT212PP	79	ZT773PP	80
Z6863PP	101	ZT232PP	79	ZT775PP	79
Z6868PP	103	ZT240PP	79	ZT790PP	79
Z6922PP	104	ZT250PP	79	ZT793PP	80
Z6942PP	86	ZT275PP	79	ZT811PP	79
Z6943PP	86	ZT290PP	79	ZT812PP	79
Z7011PP	86	ZT311PP	79	ZT816PP	79
Z7012PP	86	ZT312PP	79	ZT821PP	80
Z7016PP	86	ZT316PP	79	ZT822PP	80
Z7050PP	86	ZT321PP	80	ZT826PP	80
Z7075PP	86	ZT322PP	80	ZT832PP	79
Z7090PP	86	ZT326PP	80	ZT833PP	80
Z7111PP	91	ZT332PP	79	ZT840PP	79
Z7112PP	91	ZT333PP	80	ZT843PP	80
Z7116PP	91	ZT340PP	79	ZT850PP	79
Z7132PP	91	ZT343PP	80	ZT853PP	80
Z7140PP	91	ZT350PP	79	ZT873PP	80
Z7150PP	91	ZT353PP	80	ZT875PP	79
Z7175PP	91	ZT373PP	80	ZT890PP	79
Z7190PP	91	ZT375PP	79	ZT893PP	80
Z7450PP	29	ZT390PP	79	ZVA50PP	98
Z7450PP	96	ZT393PP	80	ZVA51PP	98
Z7470PP	96	ZT511PP	79		
Z7713PP	243	ZT512PP	79		
Z7713PP	248	ZT516PP	79		
Z7811PP	96	ZT521PP	80		
Z7812PP	96	ZT522PP	80		
Z7816PP	96	ZT526PP	80		
Z7850PP	96	ZT532PP	79		
Z7875PP	96	ZT533PP	80		
Z7890PP	96	ZT540PP	79		
Z7911PP	116	ZT543PP	80		
Z7950PP	116	ZT550PP	79		
Z7975PP	116	ZT553PP	80		
Z8011PP	116	ZT573PP	80		
Z8050PP	116	ZT575PP	79		
Z9411PP	96	ZT590PP	79		
Z9511P8	29	ZT593PP	80		
Z9511PP	96	ZT611PP	79		
Z9711PP	96	ZT612PP	79		
Z9811PP	96	ZT616PP	79		
ZAB11PP	91	ZT621PP	80		
ZCA11PP	106	ZT622PP	80		
ZCA12PP	106	ZT632PP	79		
ZCA16PP	106	ZT633PP	80		
ZCA40PP	106	ZT640PP	79		
ZCA50PP	106	ZT643PP	80		
ZCA75PP	106	ZT650PP	79		
ZCA90PP	106	ZT653PP	80		
ZCS50PP	108	ZT673PP	80		
ZGW12PP	91	ZT675PP	79		
ZMG11PP	91	ZT690PP	79		
ZMG12PP	91	ZT693PP	80		

REDI

REDI S.p.A.

Via Madonna dei Prati 5/A
40069 ZOLA PREDOSA (Bologna - Italy)
Tel. +39 051 6175111

info.redi@alixaxis.com

www.alixaxis.it

Export Sales Office

Tel. +39 051 6175240 - Fax +39 051 757173

salesredi@alixaxis.com

